

ABB industrial drives

# Firmware manual ACS880 primary control program



Power and productivity  
for a better world™



# List of related manuals in English

## Drive hardware manuals

## Code (English)

---

<i>ACS880-01 drives hardware manual</i>	<a href="#">3AUA0000078093</a>
<i>ACS880-07 drives (45 to 250 kW, 60 to 300 hp) hardware manual</i>	<a href="#">3AUA0000105718</a>
<i>ACS880-104 inverter modules hardware manual</i>	<a href="#">3AUA0000104271</a>
<i>ACS880-107 inverter units hardware manual</i>	<a href="#">3AUA0000102519</a>

## Drive firmware manuals and guides

---

<i>ACS880 primary control program firmware manual</i>	<a href="#">3AUA0000085967</a>
<i>ACS880 drives with primary control program, quick start-up guide</i>	<a href="#">3AUA0000098062</a>

## Option manuals and guides

---

<i>ACS-AP-x assistant control panels user's manual</i>	<a href="#">3AUA0000085685</a>
<i>Drive composer Start-up and maintenance PC tool User's manual</i>	<a href="#">3AUA0000094606</a>
<i>Manuals and quick guides for I/O extension modules, fieldbus adapters, encoder interfaces, etc.</i>	

You can find manuals and other product documents in PDF format on the Internet. See section [Document library on the Internet](#) on the inside of the back cover. For manuals not available in the Document library, contact your local ABB representative.



[ACS880-01 manuals](#)



[ACS880-07 manuals](#)

# Firmware manual

ACS880 primary control program

Table of contents





# Table of contents

---

List of related manuals in English .....	2
--	---

## **1. Introduction to the manual**

What this chapter contains .....	11
Applicability .....	11
Safety instructions .....	11
Target audience .....	11
Contents of the manual .....	12
Related documents .....	12
Terms and abbreviations .....	12

## **2. Using the control panel**

## **3. Control locations and operating modes**

What this chapter contains .....	17
Local control vs. external control .....	18
Local control .....	18
External control .....	19
Operating modes of the drive .....	20
Speed control mode .....	20
Torque control mode .....	21
Frequency control mode .....	21
Special control modes .....	21



## **4. Program features**

What this chapter contains .....	23
Drive configuration and programming .....	24
Programming via parameters .....	24
Application programming .....	24
Control interfaces .....	26
Programmable analog inputs .....	26
Programmable analog outputs .....	26
Programmable digital inputs and outputs .....	26
Programmable relay outputs .....	26
Programmable I/O extensions .....	27
Fieldbus control .....	27
Master/follower functionality .....	27
External controller interface .....	32
Motor control .....	35
Direct torque control (DTC) .....	35
Reference ramping .....	35
Constant speeds (frequencies) .....	36
Critical speeds (frequencies) .....	36
Encoder support .....	37

---

## 6 Table of contents

Jogging	38
Scalar motor control	40
Autophasing	41
Flux braking	43
DC magnetization	43
Application control	45
Application macros	45
Process PID control	45
Mechanical brake control	48
DC voltage control	53
Overvoltage control	53
Undervoltage control	53
Voltage control and trip limits	54
Brake chopper	55
Safety and protections	56
Emergency stop	56
Motor thermal protection	56
Programmable protection functions	59
Automatic fault resets	60
Diagnostics	61
Signal supervision	61
Maintenance timers and counters	61
Energy savings calculator	61
Load analyzer	62
Miscellaneous	64
User parameter sets	64
Data storage parameters	64

## 5. Application macros

What this chapter contains	65
General	65
Factory macro	66
Default parameter settings for the Factory macro	66
Default control connections for the Factory macro	67
Hand/Auto macro	68
Default parameter settings for the Hand/Auto macro	68
Default control connections for the Hand/Auto macro	69
PID control macro	70
Default parameter settings for the PID control macro	71
Default control connections for the PID control macro	72
Sensor connection examples	73
Torque control macro	74
Default parameter settings for the Torque control macro	74
Default control connections for the Torque control macro	75
Sequential control macro	76
Operation diagram	76
Selection of constant speeds	77
Default parameter settings for the Sequential control macro	77
Default control connections for the Sequential control macro	78
Fieldbus control macro	79



## 6. Parameters

What this chapter contains .....	81
Terms and abbreviations .....	81
Summary of parameter groups .....	82
Parameter listing .....	84
01 Actual values .....	84
03 Input references .....	85
04 Warnings and faults .....	86
05 Diagnostics .....	87
06 Control and status words .....	88
07 System info .....	91
10 Standard DI, RO .....	91
11 Standard DIO, FI, FO .....	96
12 Standard AI .....	102
13 Standard AO .....	104
14 I/O extension module 1 .....	108
15 I/O extension module 2 .....	124
16 I/O extension module 3 .....	127
19 Operation mode .....	130
20 Start/stop/direction .....	132
21 Start/stop mode .....	140
22 Speed reference selection .....	145
23 Speed reference ramp .....	151
24 Speed reference conditioning .....	155
25 Speed control .....	158
26 Torque reference chain .....	164
28 Frequency reference chain .....	168
30 Limits .....	175
31 Fault functions .....	177
32 Supervision .....	183
33 Maintenance timer & counter .....	187
35 Motor thermal protection .....	193
36 Load analyzer .....	200
40 Process PID set 1 .....	203
41 Process PID set 2 .....	214
43 Brake chopper .....	215
44 Mechanical brake control .....	217
45 Energy efficiency .....	221
46 Monitoring/scaling settings .....	223
47 Data storage .....	225
49 Panel port communication .....	227
50 Fieldbus adapter (FBA) .....	227
51 FBA A settings .....	231
52 FBA A data in .....	232
53 FBA A data out .....	233
60 D2D and DDCCS communication .....	233
61 D2D and DDCCS transmit data .....	237
62 D2D and DDCCS receive data .....	239
90 Feedback selection .....	243
91 Encoder module settings .....	248



## 8 Table of contents

<i>92 Encoder 1 configuration</i> .....	250
<i>93 Encoder 2 configuration</i> .....	255
<i>95 HW configuration</i> .....	257
<i>96 System</i> .....	259
<i>97 Motor control</i> .....	262
<i>98 User motor parameters</i> .....	264
<i>99 Motor data</i> .....	265
<i>200 Safety</i> .....	269

### **7. Additional parameter data**

What this chapter contains .....	271
Terms and abbreviations .....	271
Fieldbus addresses .....	272
Parameter groups 1...9 .....	273
Parameter groups 10...99 .....	275

### **8. Fault tracing**

What this chapter contains .....	311
Safety .....	311
Indications .....	311
How to reset faults .....	312
Warning/fault history .....	312
Event log .....	312
Parameters that contain warning/fault information .....	312
Warning messages .....	313
Fault messages .....	321

### **9. Fieldbus control through the embedded fieldbus interface (EFB)**

### **10. Fieldbus control through a fieldbus adapter**

What this chapter contains .....	333
System overview .....	334
Basics of the fieldbus control interface .....	335
Control word and Status word .....	336
References .....	337
Actual values .....	338
Contents of the fieldbus Control word .....	339
Contents of the fieldbus Status word .....	340
The state diagram .....	341
Setting up the drive for fieldbus control .....	342
Parameter setting example: FPBA (PROFIBUS DP) .....	343

### **11. Drive-to-drive link**

### **12. Control chain diagrams**

What this chapter contains .....	347
Speed reference source selection I .....	348

---



Speed reference source selection II .....	349
Speed reference ramping and shaping .....	350
Motor feedback configuration .....	351
Speed error calculation .....	352
Speed controller .....	353
Torque reference source selection and modification .....	354
Reference selection for torque controller I .....	355
Reference selection for torque controller II .....	356
Torque limitation .....	357
Frequency reference selection .....	358
Frequency reference modification .....	359
Process PID setpoint and feedback source selection .....	360
Process PID controller .....	361
Master/Follower communication I (Master) .....	362
Master/Follower communication II (Follower) .....	363

### ***Further information***

Product and service inquiries .....	365
Product training .....	365
Providing feedback on ABB Drives manuals .....	365
Document library on the Internet .....	365







# Introduction to the manual

---

## What this chapter contains

This chapter describes the contents of the manual. It also contains information on the compatibility, safety and intended audience.

## Applicability

This manual applies to the ACS880 primary control program (version 1.20 or later).

The firmware version of the control program is visible in parameter [07.05 Firmware version](#), or the System info in the main menu on the control panel.

## Safety instructions

Follow all safety instructions delivered with the drive.

- Read the **complete safety instructions** before you install, commission, or use the drive. The complete safety instructions are delivered with the drive as either part of the *Hardware manual*, or, in the case of ACS880 multidrives, as a separate document.
- Read the **firmware function-specific warnings and notes** before changing parameter values. These warnings and notes are included in the parameter descriptions presented in chapter [Parameters](#).

## Target audience

This manual is intended for people who design, commission, or operate the drive system.

---

## Contents of the manual

This manual consists of the following chapters:

- [Using the control panel](#) provides the basic instructions for use of the control panel.
- [Control locations and operating modes](#) describes the control locations and operating modes of the drive.
- [Program features](#) contains descriptions of the features of the ACS880 primary control program.
- [Application macros](#) contains a short description of each macro together with a connection diagram.
- [Parameters](#) describes the parameters of the drive.
- [Additional parameter data](#) contains further information on the parameters.
- [Fault tracing](#) lists the warning and fault messages with possible causes and remedies.
- [Fieldbus control through the embedded fieldbus interface \(EFB\)](#) describes the communication to and from a fieldbus network using the embedded fieldbus interface of the drive.
- [Fieldbus control through a fieldbus adapter](#) describes the communication to and from a fieldbus network using an optional fieldbus adapter module.
- [Drive-to-drive link](#) describes the communication between drives connected together by the drive-to-drive (D2D) link.
- [Control chain diagrams](#).

## Related documents

---

**Note:** A quick start-up sequence for a speed control application is provided by *ACS880 drives with primary control program, Quick start-up guide* (3AUA0000098062), delivered with the drive.

---

A list of related manuals is printed on the inside of the front cover.

## Terms and abbreviations

Term/abbreviation	Definition
AC 800M	Type of programmable controller manufactured by ABB.
ACS-AP-I	Type of control panel used with ACS880 drives
AI	Analog input; interface for analog input signals
AO	Analog output; interface for analog output signals
BCU	Type of control unit used in ACS880 drives.
DC link	DC circuit between rectifier and inverter

---

<b>Term/abbreviation</b>	<b>Definition</b>
DDCS	Distributed drives communication system; a protocol used in optical fiber communication
DI	Digital input; interface for digital input signals
DIO	Digital input/output; interface that can be used as a digital input or output
DO	Digital output; interface for digital output signals
DTC	Direct torque control
EFB	Embedded fieldbus
FBA	Fieldbus adapter
FEN-01	Optional TTL encoder interface module
FEN-11	Optional absolute encoder interface module
FEN-21	Optional resolver interface module
FEN-31	Optional HTL encoder interface module
FIO-01	Optional digital I/O extension module
FIO-11	Optional analog I/O extension module
FCAN-0x	Optional CANopen adapter
FDCO-0x	Optional DDCS communication module
FDNA-0x	Optional DeviceNet adapter
FECA-01	Optional EtherCAT® adapter
FENA-11	Optional Ethernet/IP adapter
FLON-0x	Optional LONWORKS® adapter
FPBA-0x	Optional PROFIBUS DP adapter
FSCA-0x	Optional Modbus adapter
HTL	High-threshold logic
IGBT	Insulated gate bipolar transistor; a voltage-controlled semiconductor type widely used in inverters due to their easy controllability and high switching frequency
I/O	Input/Output
ID run	Motor identification run. During the identification run, the drive will identify the characteristics of the motor for optimum motor control.
LSB	Least significant bit
LSW	Least significant word
MSB	Most significant bit
MSW	Most significant word

Term/abbreviation	Definition
Network control	<p>With fieldbus protocols based on the Common Industrial Protocol (CIP™), such as DeviceNet and Ethernet/IP, denotes the control of the drive using the Net Ctrl and Net Ref objects of the ODVA AC/DC Drive Profile. For more information, see <a href="http://www.odva.org">www.odva.org</a>, and the following manuals:</p> <ul style="list-style-type: none"> <li>• <i>FDNA-01 DeviceNet adapter module User's manual</i> (3AFE68573360 [English]), and</li> <li>• <i>FENA-01/-11 Ethernet adapter module User's manual</i> (3AUA0000093568 [English]).</li> </ul>
Parameter	User-adjustable operation instruction to the drive, or signal measured or calculated by the drive
PID controller	Proportional–integral–derivative controller. Drive speed control is based on PID algorithm.
PLC	Programmable logic controller
Power unit	Contains the power electronics and connections of the drive. The drive control unit is connected to the power unit.
PTC	Positive temperature coefficient
RDCO-0x	Optional DDCS communication module
RFG	Ramp function generator.
RO	Relay output; interface for a digital output signal. Implemented with a relay.
SSI	Synchronous serial interface
STO	Safe torque off
TTL	Transistor-transistor logic
UPS	Uninterruptible power supply; power supply equipment with battery to maintain output voltage during power failure
ZCON	Type of control board used in ACS880 drives. The board is either integrated into the drive or fitted in a plastic housing (see <a href="#">ZCU</a> ).
ZCU	<p>Type of control unit used in ACS880 drives that consists of a ZCON board built into a plastic housing.</p> <p>The control unit may be fitted onto the drive/inverter module, or installed separately.</p>



# Using the control panel

---

Refer to *ACS-AP-x assistant control panels user's manual* (3AUA0000085685 [English]).

---







# Control locations and operating modes

---

## What this chapter contains

This chapter describes the control locations and operating modes supported by the control program.

---

## Local control vs. external control

The ACS880 has two main control locations: external and local. The control location is selected with the Loc/Rem key on the control panel or in the PC tool.

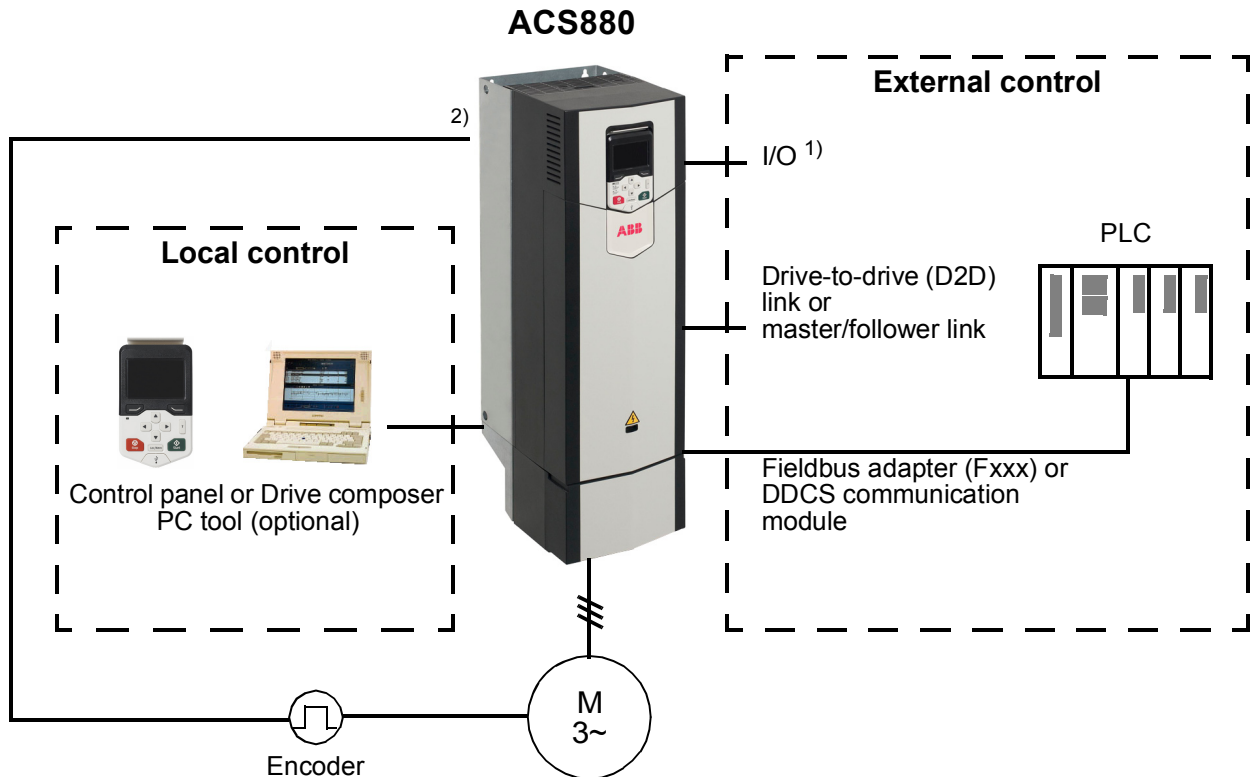

1) Extra inputs/outputs can be added by installing optional I/O extension modules (FIO-xx) in drive slots.

2) Encoder or resolver interface module(s) (FEN-xx) installed in drive slots.

### Local control

The control commands are given from the control panel keypad or from a PC equipped with Drive composer when the drive is in local control. Speed and torque control modes are available for local control; frequency mode is available when scalar motor control mode is used (see parameter [19.16 Local control mode](#)).

Local control is mainly used during commissioning and maintenance. The control panel always overrides the external control signal sources when used in local control. Changing the control location to local can be prevented by parameter [19.17 Local control disable](#).

The user can select by a parameter ([49.05 Communication loss action](#)) how the drive reacts to a control panel or PC tool communication break. (The parameter has no effect in external control.)

## ■ External control

When the drive is in external control, control commands are given through

- the I/O terminals (digital and analog inputs), or optional I/O extension modules
- the fieldbus interface (via an optional fieldbus adapter module)
- the external (DDCS) controller interface, and/or
- the master/follower link.

Two external control locations, EXT1 and EXT2, are available. The user can select the sources of the start and stop commands separately for each location by parameters [20.01](#)...[20.10](#). The operating mode can be selected separately for each location, which enables quick switching between different operating modes, for example speed and torque control. Selection between EXT1 and EXT2 is done via any binary source such as a digital input or fieldbus control word (see parameter [19.11 Ext1/Ext2 selection](#)). The source of reference is selectable for each operating mode separately.

---

## Operating modes of the drive

The drive can operate in several operating modes with different types of reference. The mode is selectable for each control location (Local, EXT1 and EXT2) in parameter group [19 Operation mode](#).

The following is a general representation of the reference types and control chains. The page numbers refer to detailed diagrams in chapter [Control chain diagrams](#).

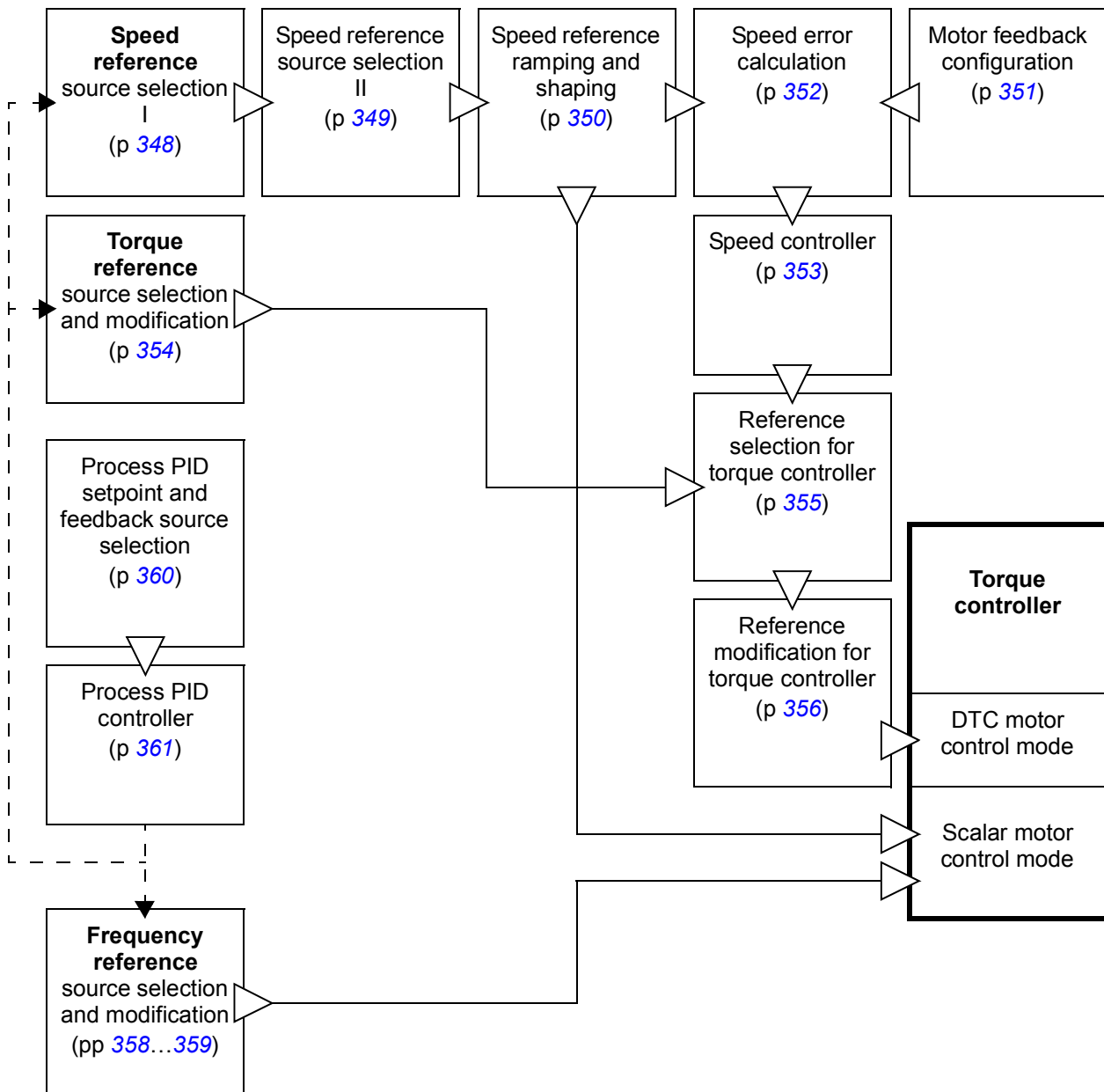

### ■ Speed control mode

The motor follows a speed reference given to the drive. This mode can be used either with estimated speed used as feedback, or with an encoder or resolver for better speed control accuracy.

Speed control mode is available in both local and external control. It is also available both in DTC (Direct Torque Control) and scalar motor control modes.

### ■ Torque control mode

Motor torque follows a torque reference given to the drive. This mode can be used either with or without an encoder or resolver. When used with an encoder or resolver, this mode provides for more accurate and dynamic motor control.

Torque control mode is available in both local and external control.

### ■ Frequency control mode

The motor follows a frequency reference given to the drive. Frequency control is only available for scalar motor control.

### ■ Special control modes

In addition to the above-mentioned control modes, the following special control modes are available:

- Process PID control. For more information, see section [Process PID control](#) (page 45).
  - Emergency stop modes OFF1 and OFF3: Drive stops along the defined deceleration ramp and drive modulation stops.
  - Jogging mode: Drive starts and accelerates to the defined speed when the jogging signal is activated. For more information, see section [Jogging](#) (page 38).
-





# Program features

---

## What this chapter contains

This chapter describes the features of the control program.

---

## Drive configuration and programming

The drive control program is divided into two parts:

- firmware program
- application program.

### Drive control program

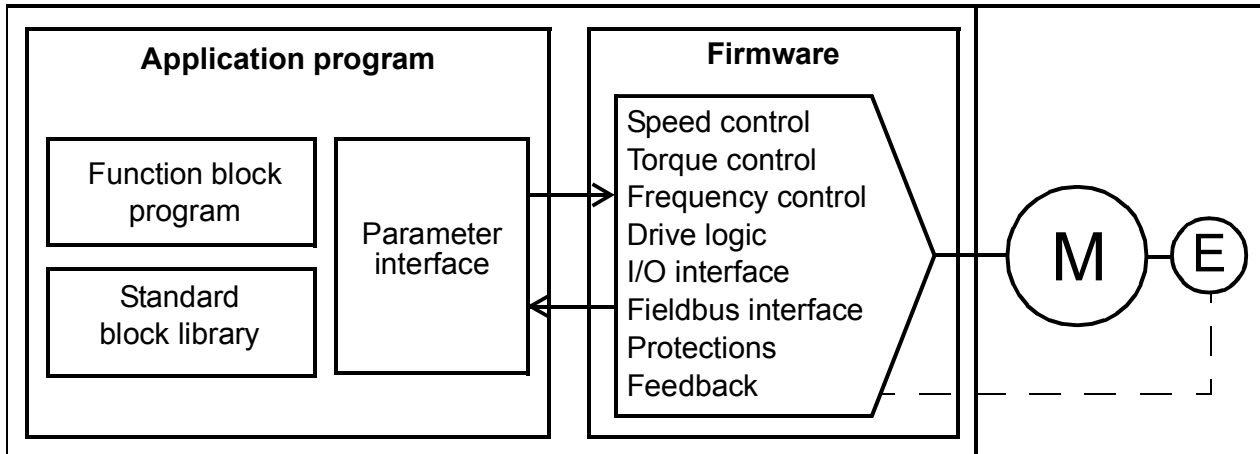

The firmware program performs the main control functions, including speed and torque control, drive logic (start/stop), I/O, feedback, communication and protection functions. Firmware functions are configured and programmed with parameters.

### ■ Programming via parameters

Parameters can be set via

- the control panel, as described in chapter [Using the control panel](#)
- the Drive composer PC tool, as described in *Drive composer user's manual* (3AUA0000094606 [English]), or
- the fieldbus interface, as described in chapters [Fieldbus control through the embedded fieldbus interface \(EFB\)](#) and [Fieldbus control through a fieldbus adapter](#).

All parameter settings are stored automatically to the permanent memory of the drive. However, if an external +24 V DC power supply is used for the drive control unit, it is highly recommended to force a save by using parameter [96.07 Parameter save](#) before powering down the control unit after any parameter changes.

If necessary, the default parameter values can be restored by parameter [96.06 Parameter restore](#).

### ■ Application programming

The functions of the firmware program can be extended with application programming. (A standard drive delivery does not include an application program.)



Application programs can be built out of function blocks based on the IEC-61131 standard.

## Control interfaces

### ■ Programmable analog inputs

The control unit has two programmable analog inputs. Each of the inputs can be independently set as a voltage (0/2...10 V or -10...10 V) or current (0/4...20 mA) input by a jumper on the control unit. Each input can be filtered, inverted and scaled. The number of analog inputs can be increased by using FIO-xx I/O extensions.

#### Settings

Parameter group [12 Standard AI](#) (page [102](#)).

### ■ Programmable analog outputs

The control unit has two current (0...20 mA) analog outputs. Each output can be filtered, inverted and scaled. The number of analog outputs can be increased by using FIO-xx I/O extensions.

#### Settings

Parameter group [13 Standard AO](#) (page [104](#)).

### ■ Programmable digital inputs and outputs

The control unit has six digital inputs, a digital start interlock input, and two digital input/outputs.

One digital input (DI6) doubles as a PTC thermistor input. See section [Motor thermal protection](#) (page [56](#)).

Digital input/output DIO1 can be used as a frequency input, DIO2 as a frequency output.

The number of digital inputs/outputs can be increased by using FIO-xx I/O extensions.

#### Settings

Parameter groups [10 Standard DI, RO](#) (page [91](#)) and [11 Standard DIO, FI, FO](#) (page [96](#)).

### ■ Programmable relay outputs

The control unit has three relay outputs. The signal to be indicated by the outputs can be selected by parameters.

Relay outputs can be added by using FIO-0x I/O extensions.

#### Settings

Parameter group [10 Standard DI, RO](#) (page [91](#)).

---

## ■ Programmable I/O extensions

Inputs and outputs can be added by using FIO-xx I/O extension modules. One to three modules can be mounted on the slots of the control unit.

The table below shows the number of I/O on the control unit as well as optional FIO-xx I/O extension modules.

Location	Digital inputs (DI)	Digital I/Os (DIO)	Analog inputs (AI)	Analog outputs (AO)	Relay outputs (RO)
Control unit	7	2	2	2	3
FIO-01	-	4	-	-	2
FIO-11	-	2	3	1	-

Three I/O extension modules can be activated and configured using parameter groups 14...16.

**Note:** Each configuration parameter group contains parameters that display the values of the inputs on that particular extension module. These parameters are the only way of utilizing the inputs on I/O extension modules as signal sources. To connect to an input, choose the setting *Other* in the source selector parameter, then specify the appropriate value parameter (and bit, for digital signals) in group 14, 15 or 16.

### Settings

Parameter groups [14 I/O extension module 1](#) (page 108), [15 I/O extension module 2](#) (page 124) and [16 I/O extension module 3](#) (page 127).

## ■ Fieldbus control

The drive can be connected to several different automation systems through its fieldbus interfaces. See chapter [Fieldbus control through a fieldbus adapter](#) (page 333).

### Settings

Parameter groups [50 Fieldbus adapter \(FBA\)](#) (page 227), [51 FBA A settings](#) (page 231), [52 FBA A data in](#) (page 232), and [53 FBA A data out](#) (page 233).

## ■ Master/follower functionality

### General

The master/follower functionality can be used to link several drives together so that the load can be evenly distributed between the drives. This is ideal in applications where the motors are coupled to each other via gearing, chain, belt, etc.

The external control signals are typically connected to one drive only which acts as the master. The master controls up to 10 followers by sending broadcast messages over a fiber optic serial communication link. The master can read feedback signals from up to 3 selected followers.

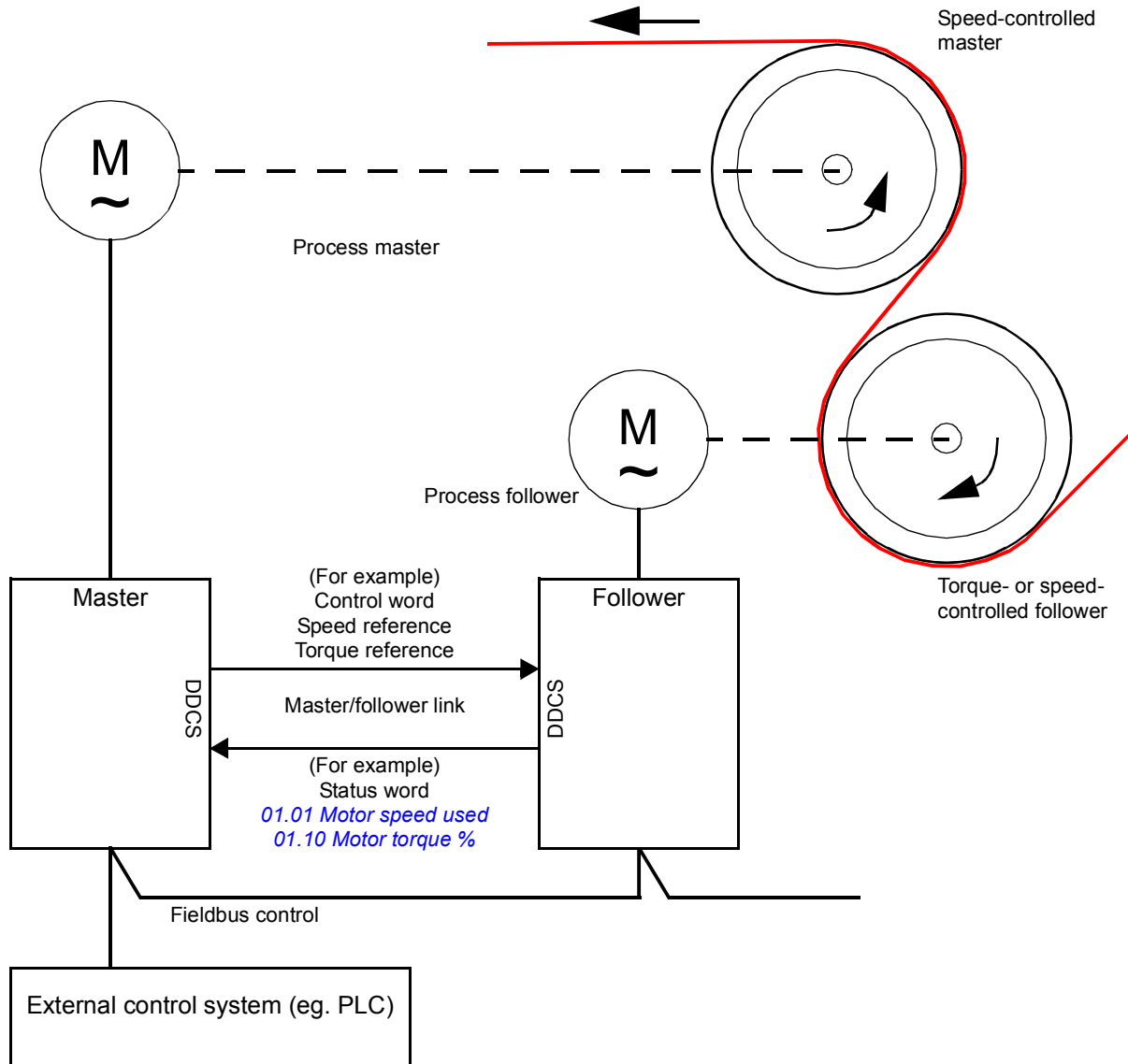

Parameter [60.03 M/F mode](#) defines whether the drive is the master or a follower on the communication link. Typically, the speed-controlled process master drive is also configured as the master in the communication.

The master drive is typically speed-controlled and the other drives follow its torque or speed reference. In general, a follower should be

- torque-controlled when the motor shafts of the master and the follower are rigidly coupled by gearing, chain etc. so that no speed difference between the drives is possible
- speed-controlled when the motor shafts of the master and the follower are flexibly coupled so that a slight speed difference is possible. When both the master and the follower are speed-controlled, drooping is also typically used (see parameter [25.08 Drooping rate](#)).

In some applications, both speed control and torque control of the follower are required. In those cases, an “on-the-fly” change between speed and torque control can be performed via a digital input of the follower. With torque control, follower parameter [26.15 Load share](#) can be used to scale the incoming torque reference for optimal load sharing between the master and the follower. Pulse encoders are recommended to be used in all torque-controlled followers.

If a drive needs to quickly switch between master and follower statuses, one user parameter set (see page [64](#)) can be saved with the master settings, another with the follower settings. The suitable settings can then be activated using eg. digital inputs.

## Communication

The communication on the fiber optic link is based on the DDCS protocol, which employs data sets (specifically, data set 41). One data set contains three 16-bit words. The contents of the data set are freely configurable, but the data set broadcast by the master typically contains the control word, speed reference and torque reference, while the followers return a status word with two actual values. The followers from which data is read are selected by parameter [60.14 M/F follower selection](#) in the master. In each follower drive, the data to be sent is selected by parameters [61.01](#)...[61.03](#). The data is transferred in integer format over the link, and then displayed by parameters [62.04](#)...[62.12](#) in the master.

To indicate faults or warnings in the followers, external events (see parameter group [31 Fault functions](#)) can be used. For example, use bit 3 (Fault) of the status word received from a follower (typically parameter [62.04 Follower node 2 data 1 sel](#)) to trigger an external event.

Block diagrams of the master/follower communication are presented on pages [362](#) and [363](#).

## Construction of the fiber optic link

The master/follower link is formed by connecting the drives together using fiber optic cables. Drives with a ZCU-11 or ZCU-13 control unit require an additional FDCO DDCS communication module; drives with a BCU-x2 control unit require an RDCO module.

Examples of star and ring configurations are shown below. Star configuration requires an NDBU-95C DDCS branching unit.

*Ring configuration*

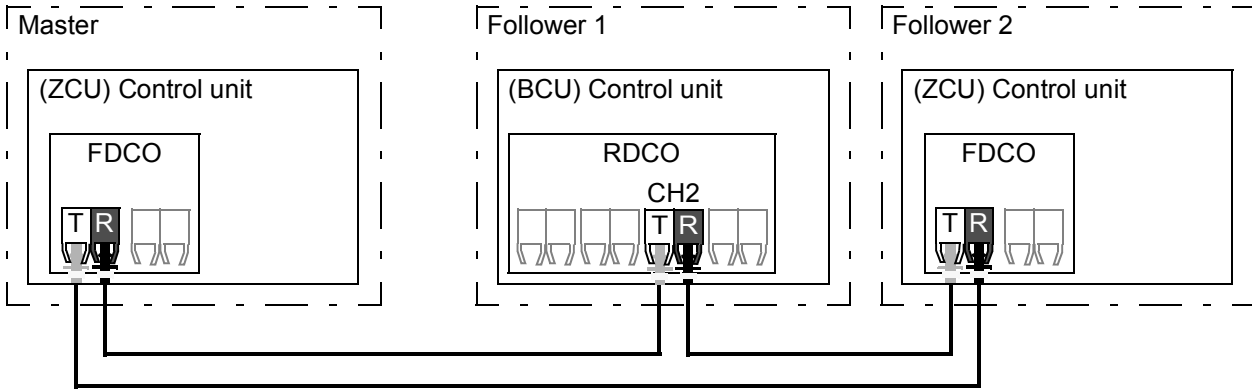

T = Transmitter; R = Receiver

*Star configuration (1)*

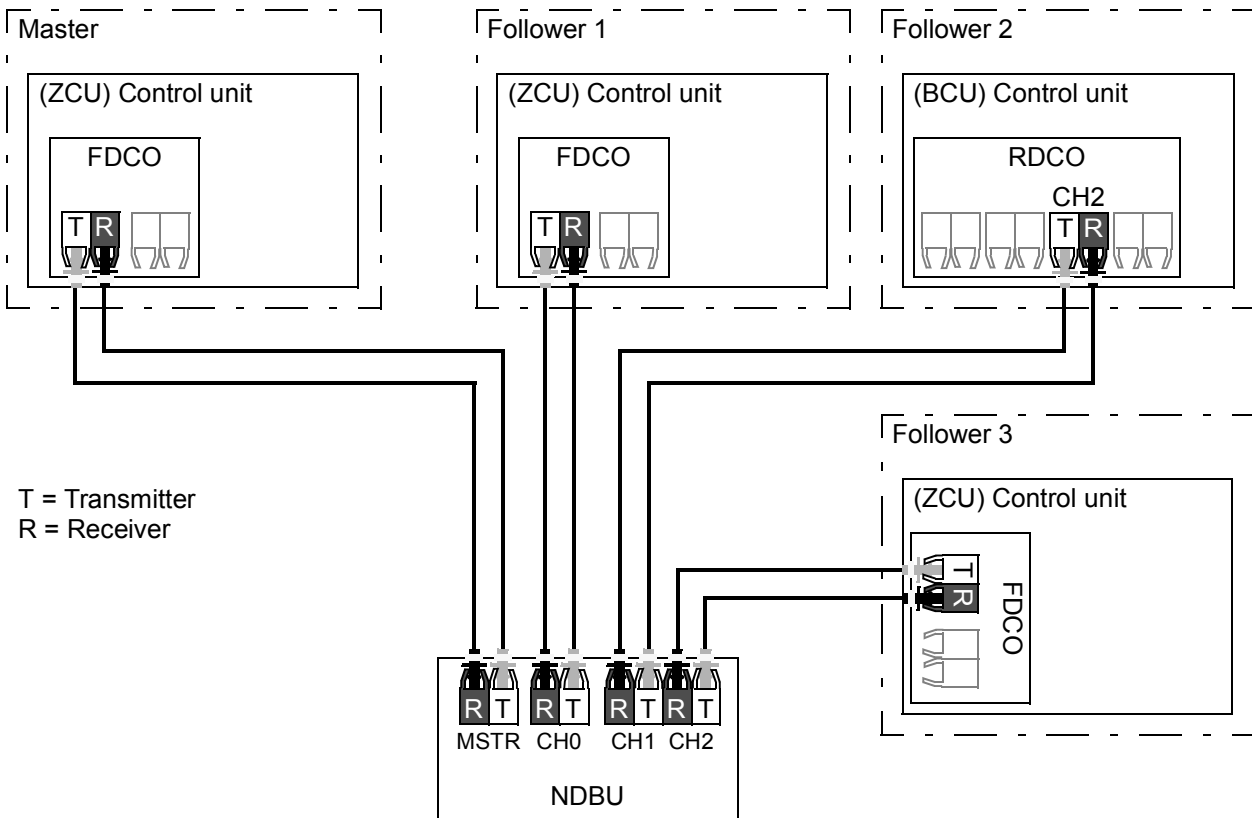

T = Transmitter  
R = Receiver

## Star configuration (2)

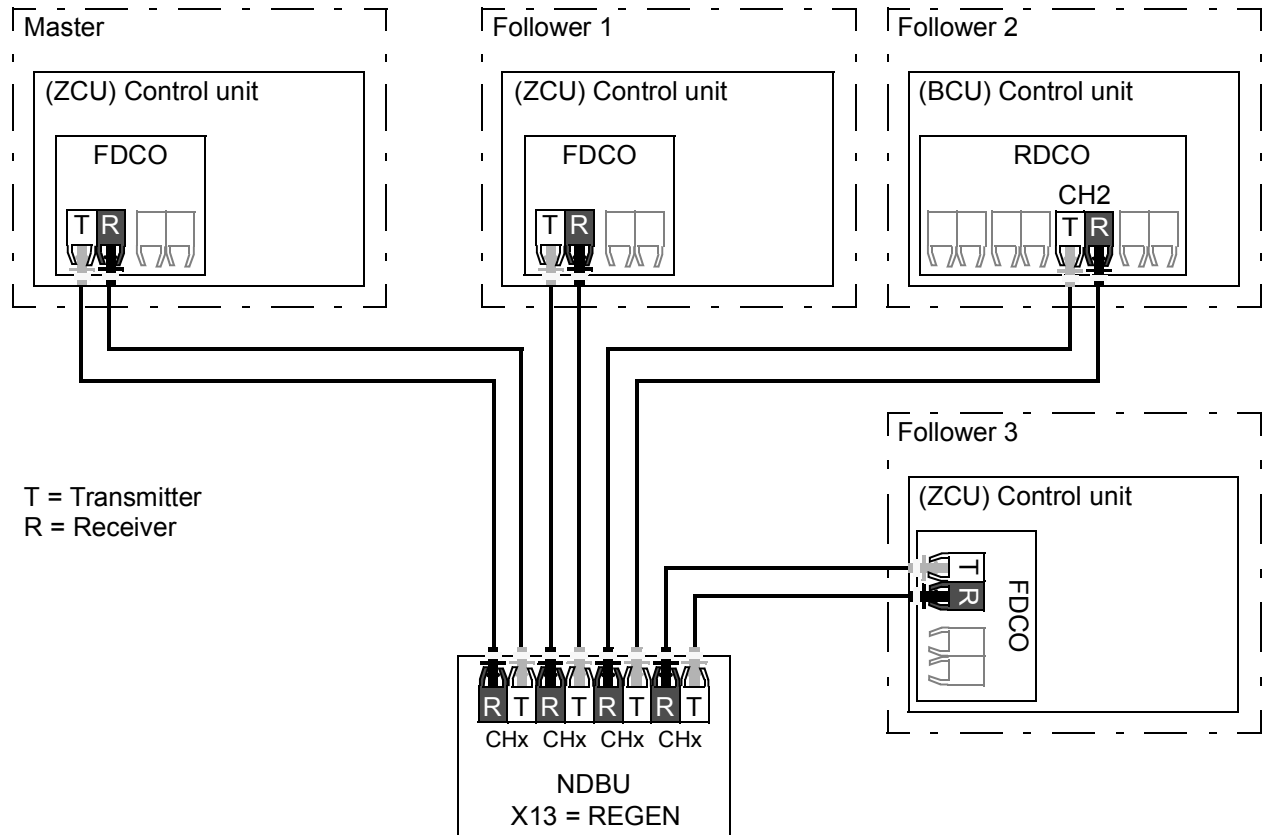

## Example parameter settings

The following is a checklist of parameters that need to be set when configuring the master/follower link. In this example, the master broadcasts the control word, a speed reference and a torque reference. The follower returns a status word and two actual values (this is not compulsory but is shown for clarity).

Master settings:

- Master/follower link activation
  - [60.01 M/F communication port](#) (fiber optic channel selection)
  - [\(60.02 M/F node address = 1\)](#)
  - [60.03 M/F mode = Master](#)
- Data to be broadcast to the followers
  - [61.01 M/F data 1 selection = CW 16bit](#) (control word)
  - [61.02 M/F data 2 selection = Other - 24.01 Used speed reference](#) [16-bit integer] (speed reference)
  - [61.03 M/F data 3 selection = Other - 26.01 Torque ref to TC](#) [16-bit integer] (torque reference)
- Data to be read from the followers (optional)
  - [60.14 M/F follower selection](#) (selection of followers that data is read from)
  - [62.04 Follower node 2 data 1 sel ... 62.12 Follower node 4 data 3 sel](#) (mapping of data received from followers)

### Follower settings:

- Master/follower link activation
  - [60.01 M/F communication port](#) (fiber optic channel selection)
  - [60.02 M/F node address](#) = 2...60
  - [60.03 M/F mode](#) = *Follower*
- Mapping of data received from master
  - [62.01 M/F data 1 selection](#) = *CW 16bit*
  - [62.02 M/F data 2 selection](#) = *Ref1 16bit*
  - [62.03 M/F data 3 selection](#) = *Ref2 16bit*
- Selection of control location
  - [20.01 Ext1 commands](#) = *D2D or M/F link*
  - [20.02 Ext1 start trigger](#) = *Level*
- Selection of reference sources
  - [22.11 Speed ref1 selection](#) = *D2D or M/F reference 1*
  - [26.11 Torque ref1 selection](#) = *D2D or M/F reference 2*
- Selection of data to be sent to master (optional)
  - [61.01 M/F data 1 selection](#) = *SW 16bit*
  - [61.02 M/F data 2 selection](#) = *Act1 16bit*
  - [61.03 M/F data 3 selection](#) = *Act2 16bit*

### **Specifications of the master/follower link**

- Maximum fiber optic cable length:
  - FDCO-01/02 with POF (Plastic Optic Fiber): 30 m
  - FDCO-01/02 with HCS (Hard-clad Silica Fiber): 200 m
  - RDCO-04 (with BCU-x2 only) with POF (Plastic Optic Fiber): 10 m
  - For distances up to 1000 m, use two NOCR-01 optical converter/repeaters with glass optic cable (GOF, 6.25 micrometers, Multi-Mode)
- Transmission rate: 4 Mbit/s
- Total performance of the link: < 5 ms to transfer references between the master and followers.
- Protocol: DDCS (Distributed Drives Communication System)

### **Settings and diagnostics**

Parameter groups [60 D2D and DDCS communication](#) (page 233), [61 D2D and DDCS transmit data](#) (page 237) and [62 D2D and DDCS receive data](#) (page 239).

## **External controller interface**

### **General**

The drive can be connected to an external controller (such as the ABB AC 800M) using fiber optic cables. Drives with a ZCU-11 or ZCU-13 control unit require an

---



additional FDCO DDCS communication module; drives with a BCU-x2 control unit require an RDCO module.

## Topology

An example connection with either a ZCU-based or BCU-based drive is shown below. Ring and star configurations are also possible much in the same way as with the master/follower link (see section [Master/follower functionality](#) on page 27); the notable difference is that the external controller connects to channel CH0 on the RDCO board instead of CH2. With ZCU-based drives, the channel on the FDCO communication module can be freely selected.

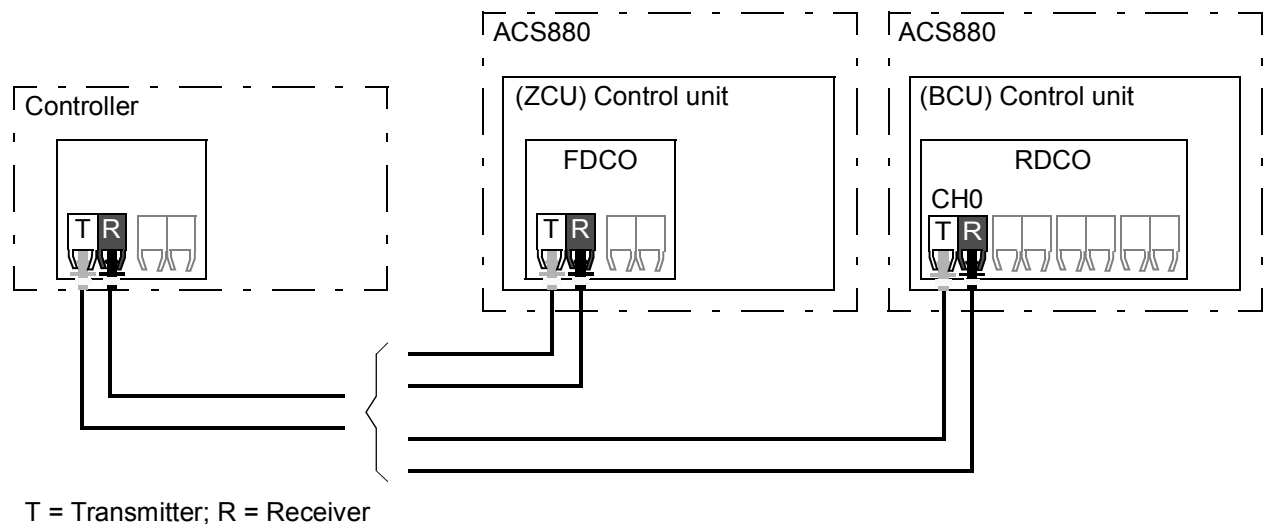

## Communication

The communication between the controller and the drive consists of data sets of three 16-bit words each. The controller sends a data set to the drive, which returns the next data set to the controller.

The communication uses data sets 10...33. Data sets with even numbers are sent by the controller to the drive, while data sets with odd numbers are sent by the drive to the controller. The contents of the data sets are freely configurable, but data set 10 typically contains the control word and one or two references, while data set 11 returns the status word and selected actual values.

The word that is defined as the control word is internally connected to the drive logic; the coding of the bits is as presented in section [Contents of the fieldbus Control word](#) (page 339). Likewise, the coding of the status word is as shown in section [Contents of the fieldbus Status word](#) (page 340).

Data sets 32 and 33 are dedicated for mailbox use; they can be used for setting or inquiring parameter values as follows:

## 34 Program features

Controller

ACS880

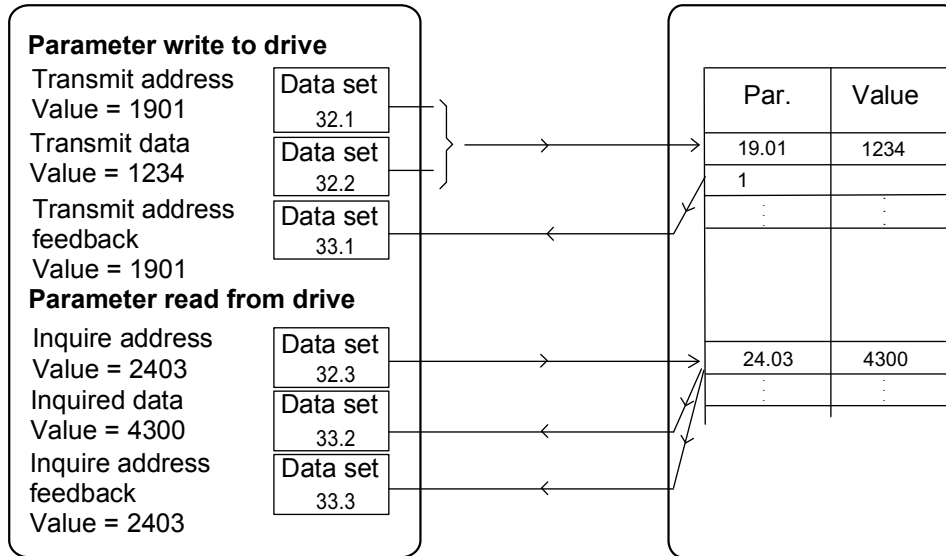

## Settings

Parameter groups [60 D2D and DDCS communication](#) (page 233), [61 D2D and DDCS transmit data](#) (page 237) and [62 D2D and DDCS receive data](#) (page 239).

## Motor control

### ■ Direct torque control (DTC)

The motor control of the ACS880 is based on direct torque control (DTC). The switching of the output semiconductors is controlled to achieve the required stator flux and motor torque. The switching frequency is changed only if the actual torque and stator flux values differ from their reference values by more than the allowed hysteresis. The reference value for the torque controller comes from the speed controller or directly from an external torque reference source.

Motor control requires measurement of the DC voltage and two motor phase currents. Stator flux is calculated by integrating the motor voltage in vector space. Motor torque is calculated as a cross product of the stator flux and the rotor current. By utilizing the identified motor model, the stator flux estimate is improved. Actual motor shaft speed is not needed for the motor control.

The main difference between traditional control and DTC is that torque control has the same time level as the power switch control. There is no separate voltage and frequency controlled PWM modulator; the output stage switching is wholly based on the electromagnetic state of the motor.

The best motor control accuracy is achieved by activating a separate motor identification run (ID run).

See also section [Scalar motor control](#) (page 40).

### Settings

Parameters [99.04 Motor ctrl mode](#) (page 266) and [99.13 Identification run request](#) (page 267).

### ■ Reference ramping

Acceleration and deceleration ramping times can be set individually for speed, torque and frequency reference.

With a speed or frequency reference, the ramps are defined as the time it takes for the drive to accelerate or decelerate between zero speed or frequency and the value defined by parameter [46.01 Speed scaling](#) or [46.02 Frequency scaling](#). The user can switch between two preset ramp sets using a binary source such as a digital input. For speed reference, also the shape of the ramp can be controlled.

With a torque reference, the ramps are defined as the time it takes for the reference to change between zero and nominal motor torque (parameter [01.30 Nominal torque scale](#)).

---

## Special acceleration/deceleration ramps

The acceleration/deceleration times for the jogging function can be defined separately; see section [Jogging](#) (page 38). Furthermore, a deceleration ramp can be defined for emergency stop (“Off3” mode).

### Settings

- Speed reference ramping: Parameters [23.11...23.19](#) and [46.01](#) (pages [151](#) and [223](#)).
- Torque reference ramping: Parameters [01.30](#), [26.18](#) and [26.19](#) (pages [85](#) and [165](#)).
- Frequency reference ramping: Parameters [28.71...28.75](#) and [46.02](#) (pages [172](#) and [223](#)).
- Jogging: Parameters [23.20](#) and [23.21](#) (page [154](#)).
- Emergency stop (“Off3” mode): Parameter [23.23 Emergency stop time](#) (page [154](#)).

### ■ Constant speeds (frequencies)

It is possible to predefine up to 7 constant speeds. Constant speeds can be activated, for example, through digital inputs. Constant speeds override the normal speed reference.

For frequency control, seven constant frequencies can be defined in the same way.

### Settings

Parameter groups [22 Speed reference selection](#) (page [145](#)) and [28 Frequency reference chain](#) (page [168](#)).

### ■ Critical speeds (frequencies)

A critical speeds function is available for applications where it is necessary to avoid certain motor speeds or speed ranges because of, for example, mechanical resonance problems.

A similar function is available for scalar motor control with a frequency reference.

---

## Example

A fan has vibrations in the range of 540 to 690 rpm and 1380 to 1560 rpm. To make the drive jump over these speed ranges,

- enable the critical speeds function by turning on bit 0 of parameter [22.51 Critical speed function](#), and
- set the critical speed ranges as in the figure below.

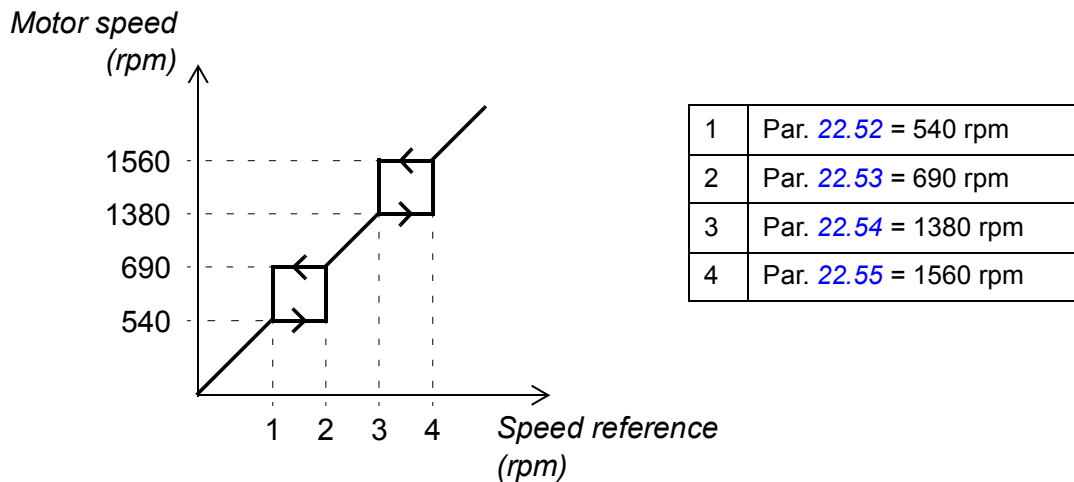

## Settings

Parameter groups [22 Speed reference selection](#) (page 145) and [28 Frequency reference chain](#) (page 168).

### Encoder support

The program supports two single-turn or multiturn encoders (or resolvers). The following optional interface modules are available:

- TTL encoder interface FEN-01: two TTL inputs, TTL output (for encoder emulation and echo) and two digital inputs for position latching
- Absolute encoder interface FEN-11: absolute encoder input, TTL input, TTL output (for encoder emulation and echo) and two digital inputs for position latching
- Resolver interface FEN-21: resolver input, TTL input, TTL output (for encoder emulation echo) and two digital inputs for position latching
- HTL encoder interface FEN-31: HTL encoder input, TTL output (for encoder emulation and echo) and two digital inputs for position latching.

The interface module is installed onto any option slot on the drive control unit, or onto an FEA-xx extension adapter.

### Quick configuration of HTL encoder feedback

1. Specify the type of the encoder interface module (parameter [91.11 Module 1 type](#) = [FEN-31](#)) and the slot the module is installed into ([91.12 Module 1 location](#)).

2. Specify the type of the encoder ([92.01 Encoder 1 type = HTL](#)). The parameter listing will be re-read from the drive after the value is changed.
3. Specify the interface module the encoder is connected to ([92.02 Encoder 1 source = Module 1](#)).
4. Set the number of pulses according to encoder nameplate ([92.10 Pulses/revolution](#)).
5. If the encoder rotates at a different speed to the motor (ie. is not mounted directly on the motor shaft), enter the gear ratio in [90.43 Motor gear numerator](#) and [90.44 Motor gear denominator](#).
6. Set parameter [91.10 Encoder parameter refresh](#) to *Configure* to apply the new parameter settings. The parameter will automatically revert to *Done*.
7. Check that [91.02 Module 1 status](#) and [92.03 Encoder 1 type act](#) are showing the correct interface module and encoder types (*HTL* and *FEN-31* respectively). Also check the status of the FEN-31 module; both LEDs should be glowing green.
8. Start the motor with a reference of eg. 400 rpm.
9. Compare the estimated speed ([01.02 Motor speed estimated](#)) with the measured speed ([01.04 Encoder 1 speed filtered](#)). If the values are the same, set the encoder as the feedback source ([90.41 Motor feedback selection = Encoder 1](#)).
10. Specify the action taken in case the feedback signal is lost ([90.45 Motor feedback fault](#)).

## Settings

Parameter groups [90 Feedback selection](#) (page 243), [91 Encoder module settings](#) (page 248), [92 Encoder 1 configuration](#) (page 250) and [93 Encoder 2 configuration](#) (page 255).

## ■ Jogging

Two jogging functions (1 or 2) are available. When a jogging function is activated, the drive starts and accelerates to the defined jogging speed (parameter [22.42 Jogging 1 ref](#) or [22.43 Jogging 2 ref](#)) along the defined jogging acceleration ramp ([23.20 Acc time jogging](#)). When the function is deactivated (Jogging 1/2 start = 0), the drive decelerates to a stop along the defined jogging deceleration ramp ([23.21 Dec time jogging](#)). One push button can be used to start and stop the drive during jogging. The jogging function is typically used during servicing or commissioning to control the machinery locally.

Jogging functions 1 and 2 are activated by a parameter. The jogging function can also be activated through eg. fieldbus or application program (see [06.01 Main control word](#), bits 8...9), but then the jogging acceleration/deceleration ramps mentioned above will not be observed.

---

The figure and table below describe the operation of the drive during jogging. (Note that they cannot be directly applied to jogging commands through fieldbus as those require no enable signal; see parameter [20.25 Jogging enable](#).) They also represent how the drive shifts to normal operation (= jogging inactive) when the drive start command is switched on. Jog cmd = State of the jogging input ([20.26 Jogging 1 start](#) or [20.27 Jogging 2 start](#)); Jog enable = State of the source set by [20.25 Jogging enable](#); Start cmd = State of the drive start command.

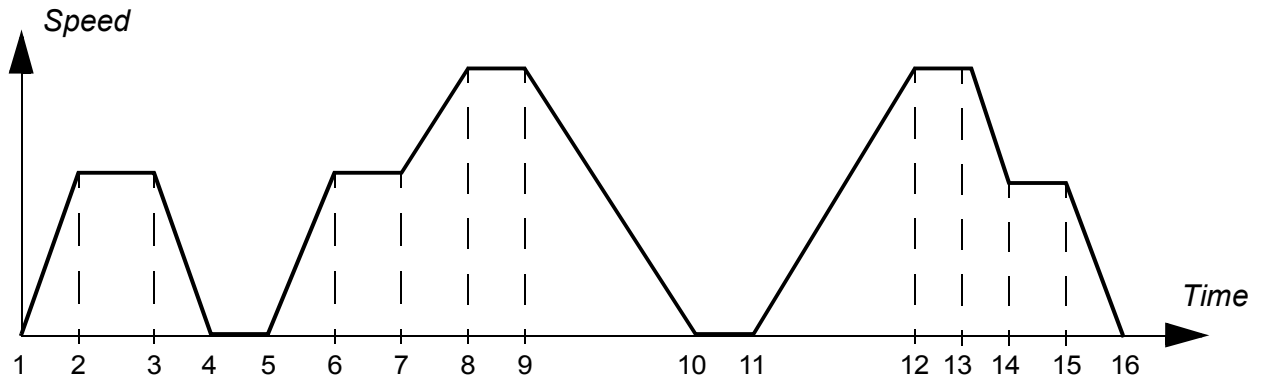

Phase	Jog cmd	Jog enable	Start cmd	Description
1-2	1	1	0	Drive accelerates to the jogging speed along the acceleration ramp of the jogging function.
2-3	1	1	0	Drive runs at the jogging speed.
3-4	0	1	0	Drive decelerates to zero speed along the deceleration ramp of the jogging function.
4-5	0	1	0	Drive is stopped.
5-6	1	1	0	Drive accelerates to the jogging speed along the acceleration ramp of the jogging function.
6-7	1	1	0	Drive runs at the jogging speed.
7-8	x	0	1	Jog enable is not active; normal operation continues.
8-9	x	0	1	Normal operation overrides the jogging. Drive follows the speed reference.
9-10	x	0	0	Drive decelerates to zero speed along the selected deceleration ramp (parameters <a href="#">23.11...23.19</a> ).
10-11	x	0	0	Drive is stopped.
11-12	x	0	1	Normal operation overrides the jogging. Drive accelerates to the speed reference along the selected acceleration ramp (parameters <a href="#">23.11...23.19</a> ).
12-13	1	1	1	Start command overrides the jog enable signal.
13-14	1	1	0	Drive decelerates to the jogging speed along the deceleration ramp of the jogging function.
14-15	1	1	0	Drive runs at the jogging speed.

Phase	Jog cmd	Jog enable	Start cmd	Description
15-16	x	0	0	Drive decelerates to zero speed along the selected deceleration ramp (parameters <a href="#">23.11</a> ... <a href="#">23.19</a> ).

**Notes:**

- Jogging is not operational when the drive start command is on, or if the drive is in local control.
- The ramp shape time is set to zero during jogging.
- The “inching” functions activated through fieldbus (see parameter [06.01 Main control word](#), bits 8...9) behave like the jogging functions but do not follow the jogging ramp times.

**Settings**

Parameters [20.25 Jogging enable](#) (page 139), [20.26 Jogging 1 start](#) (page 139), [20.27 Jogging 2 start](#) (page 140), [22.42 Jogging 1 ref](#) (page 148), [22.43 Jogging 2 ref](#) (page 149), [23.20 Acc time jogging](#) (page 154) and [23.21 Dec time jogging](#) (page 154).

### ■ Scalar motor control

It is possible to select scalar control as the motor control method instead of DTC (Direct Torque Control). In scalar control mode, the drive is controlled with a speed or frequency reference. However, the outstanding performance of DTC is not achieved in scalar control.

It is recommended to activate scalar motor control mode in the following situations:

- In multimotor drives: 1) if the load is not equally shared between the motors, 2) if the motors are of different sizes, or 3) if the motors are going to be changed after motor identification (ID run)
- If the nominal current of the motor is less than 1/6 of the nominal output current of the drive
- If the drive is used without a motor connected (for example, for test purposes)
- If the drive runs a medium-voltage motor through a step-up transformer.

In scalar control, some standard features are not available.



## IR compensation for scalar motor control

IR compensation is available only when the motor control mode is scalar. When IR compensation is activated, the drive gives an extra voltage boost to the motor at low speeds. IR compensation is useful in applications that require a high break-away torque.

In Direct Torque Control (DTC), no IR compensation is possible or needed.

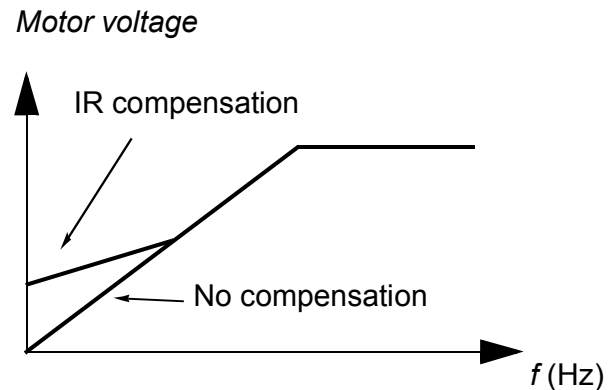

## Settings

- Parameters [19.20 Scalar control reference unit](#) (page 131), [97.13 IR compensation](#) (page 263) and [99.04 Motor ctrl mode](#) (page 266)
- Parameter group [28 Frequency reference chain](#) (page 168).

## ■ Autophasing

Autophasing is an automatic measurement routine to determine the angular position of the magnetic flux of a permanent magnet synchronous motor or the magnetic axis of a synchronous reluctance motor. The motor control requires the absolute position of the rotor flux in order to control motor torque accurately.

Sensors like absolute encoders and resolvers indicate the rotor position at all times after the offset between the zero angle of rotor and that of the sensor has been established. On the other hand, a standard pulse encoder determines the rotor position when it rotates but the initial position is not known. However, a pulse encoder can be used as an absolute encoder if it is equipped with Hall sensors, albeit with coarse initial position accuracy. The Hall sensors generate so-called commutation

pulses that change their state six times during one revolution, so it is only known within which 60° sector of a complete revolution the initial position is.

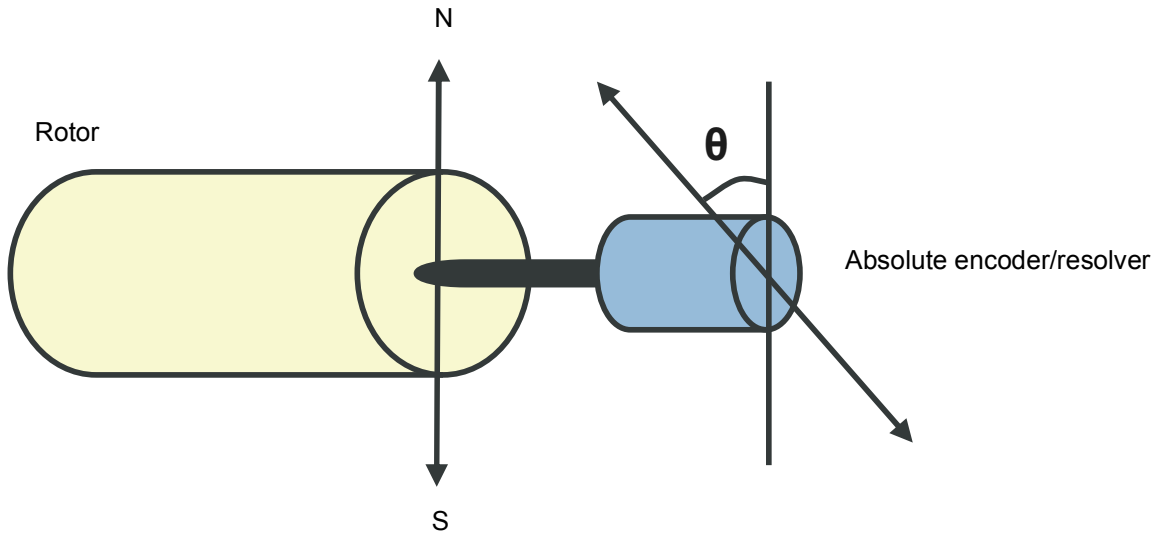

The autophasing routine is performed with permanent magnet synchronous motors and synchronous reluctance motors in the following cases:

1. One-time measurement of the rotor and encoder position difference when an absolute encoder, a resolver, or an encoder with commutation signals is used
2. At every power-up when an incremental encoder is used
3. With open-loop motor control, repetitive measurement of the rotor position at every start.

Several autophasing modes are available (see parameter [21.13 Autophasing mode](#)).

The turning mode is recommended especially with case 1 as it is the most robust and accurate method. In turning mode, the motor shaft is turned back and forward ( $\pm 360/\text{polepairs}$ )° in order to determine the rotor position. In case 3 (open-loop control), the shaft is turned only in one direction and the angle is smaller.

The standstill modes can be used if the motor cannot be turned (for example, when the load is connected). As the characteristics of motors and loads differ, testing must be done to find out the most suitable standstill mode.

A rotor position offset used in motor control can also be given by the user. See parameter [98.15 Position offset user](#).

The drive is capable of determining the rotor position when started to a running motor in open-loop or closed-loop modes. In this situation, the setting of [21.13 Autophasing mode](#) has no effect.

## Settings

Parameters [21.13 Autophasing mode](#) (page 144), [98.15 Position offset user](#) (page 265) and [99.13 Identification run request](#) (page 267).

## ■ Flux braking

The drive can provide greater deceleration by raising the level of magnetization in the motor. By increasing the motor flux, the energy generated by the motor during braking can be converted to motor thermal energy.

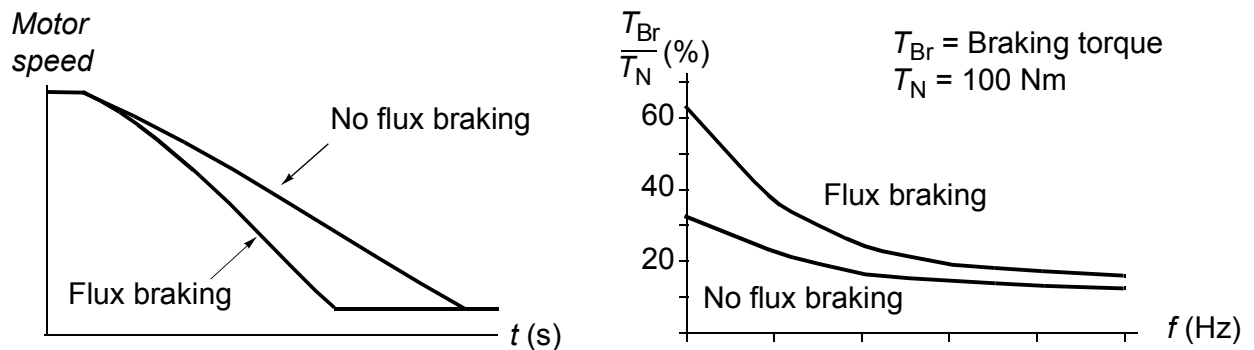

The drive monitors the motor status continuously, also during flux braking. Therefore, flux braking can be used both for stopping the motor and for changing the speed. The other benefits of flux braking are:

- The braking starts immediately after a stop command is given. The function does not need to wait for the flux reduction before it can start the braking.
- The cooling of the induction motor is efficient. The stator current of the motor increases during flux braking, not the rotor current. The stator cools much more efficiently than the rotor.
- Flux braking can be used with induction motors and permanent magnet synchronous motors.

Two braking power levels are available:

- Moderate braking provides faster deceleration compared to a situation where flux braking is disabled. The flux level of the motor is limited to prevent excessive heating of the motor.
- Full braking exploits almost all available current to convert the mechanical braking energy to motor thermal energy. Braking time is shorter compared to moderate braking. In cyclic use, motor heating may be significant.

## Settings

Parameter [97.05 Flux braking](#) (page [262](#)).

## ■ DC magnetization

DC magnetization can be applied to the motor to lock the rotor at or near zero speed.

## Pre-magnetization

Pre-magnetization refers to DC magnetization of the motor before start. Depending on the selected start mode ([21.01 Start mode](#)), pre-magnetization can be applied to

guarantee the highest possible breakaway torque, up to 200% of the nominal torque of the motor. By adjusting the pre-magnetization time ([21.02 Magnetization time](#)), it is possible to synchronize the motor start and, for example, the release of a mechanical brake.

## DC hold

The function makes it possible to lock the rotor at (near) zero speed in the middle of normal operation. DC hold is activated by parameter [21.08 DC current control](#). When both the reference and motor speed drop below a certain level (parameter [21.09 DC hold speed](#)), the drive will stop generating sinusoidal current and start to inject DC into the motor. The current is set by parameter [21.10 DC current reference](#). When the reference exceeds parameter [21.09 DC hold speed](#), normal drive operation continues.

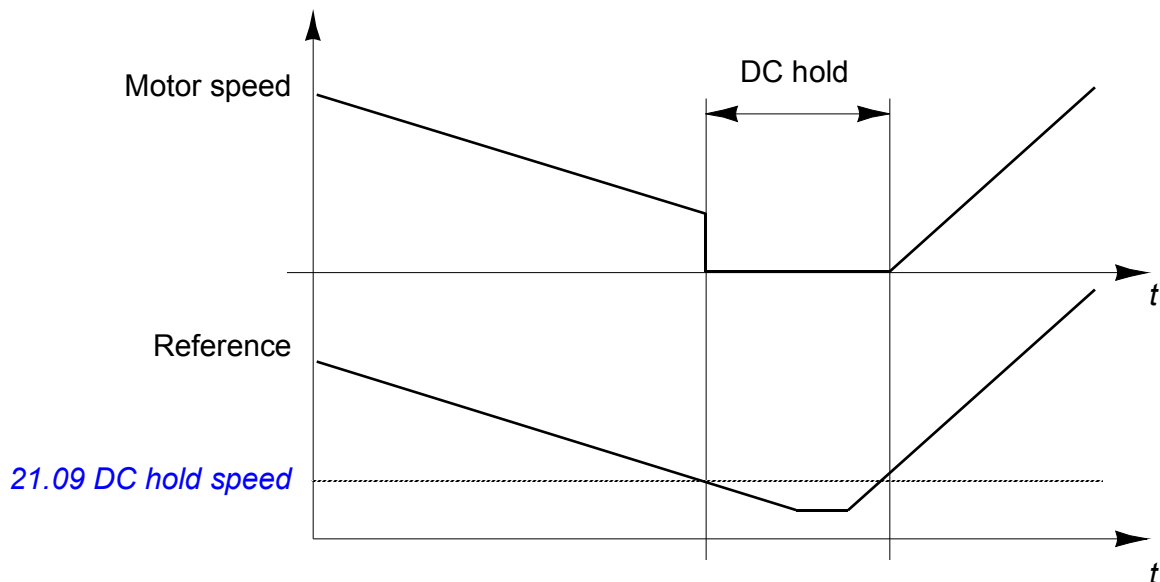

**Note:** DC hold is only available in speed control.

## Post-magnetization

This feature keeps the motor magnetized for a certain period (parameter [21.11 Post magnetization time](#)) after stopping. This is to prevent the machinery from moving under load, for example before a mechanical brake can be applied. Post-magnetization is activated by parameter [21.08 DC current control](#). The magnetization current is set by parameter [21.10 DC current reference](#).

**Note:** Post-magnetization is only available when ramping is the selected stop mode (see parameter [21.03 Stop mode](#)).

## Settings

Parameters [21.01 Start mode](#), [21.02 Magnetization time](#) and [21.08...21.11](#) (page [144](#)).

## Application control

### ■ Application macros

See chapter [Application macros](#) (page 65).

### ■ Process PID control

There is a built-in process PID controller in the drive. The controller can be used to control process variables such as pressure, flow or fluid level.

In process PID control, a process reference (setpoint) is connected to the drive instead of a speed reference. An actual value (process feedback) is also brought back to the drive. The process PID control adjusts the drive speed in order to keep the measured process quantity (actual value) at the desired level (setpoint).

The simplified block diagram below illustrates the process PID control. For a more detailed block diagram, see page 360.

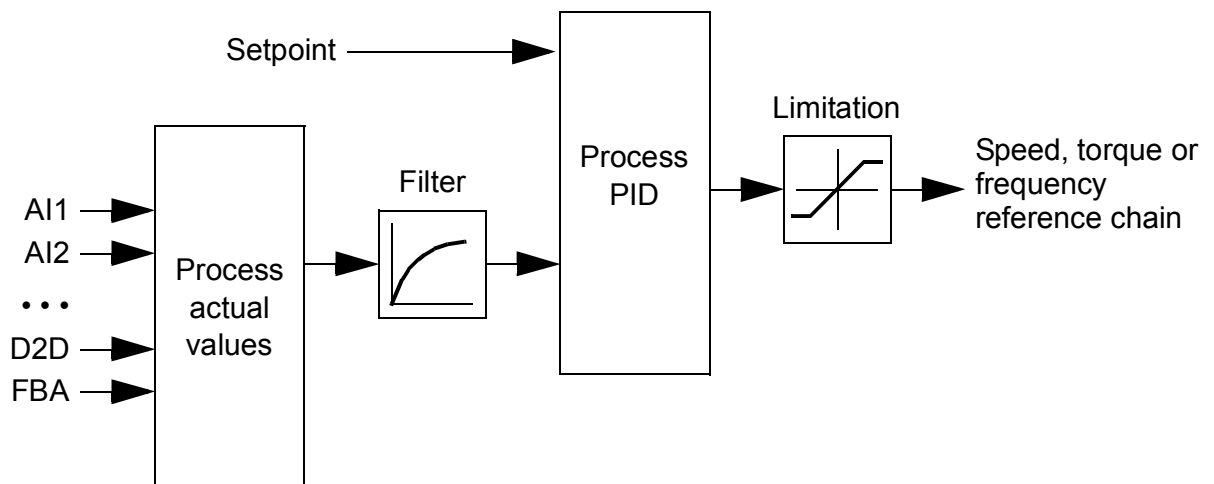

The control program contains two complete sets of process PID controller settings that can be alternated whenever necessary; see parameter [40.57 Sel between set1 set2](#).

**Note:** Process PID control is only available in external control; see section [Local control vs. external control](#) (page 18).

### Quick configuration of the process PID controller

1. Activate the process PID controller (parameter [40.07 PID operation mode](#)).
2. Select a feedback source (parameters [40.08...40.11](#)).
3. Select a setpoint source (parameters [40.16...40.25](#)).
4. Set the gain, integration time, derivation time, and the PID output levels ([40.32 Gain](#), [40.33 Integration time](#), [40.34 Derivation time](#), [40.36 Output min](#) and [40.37 Output max](#)).
5. The PID controller output is shown by parameter [40.01 Process PID actual value](#). Select it as the source of, for example, [22.11 Speed ref1 selection](#).

### Sleep function for process PID control

The sleep function can be used in PID control applications where the consumption varies. When used, it stops the pump completely during low demand, instead of running the pump slowly below its efficient operating range. The following example visualizes the operation of the sleep function.

The drive controls a pressure boost pump. The water consumption falls at night. As a consequence, the process PID controller decreases the motor speed. However, due to natural losses in the pipes and the low efficiency of the centrifugal pump at low speeds, the motor would never stop rotating. The sleep function detects the slow rotation and stops the unnecessary pumping after the sleep delay has passed. The drive shifts into sleep mode, still monitoring the pressure. The pumping resumes when the pressure falls under the wake-up level (setpoint - wake-up deviation) and the wake-up delay has passed.

---

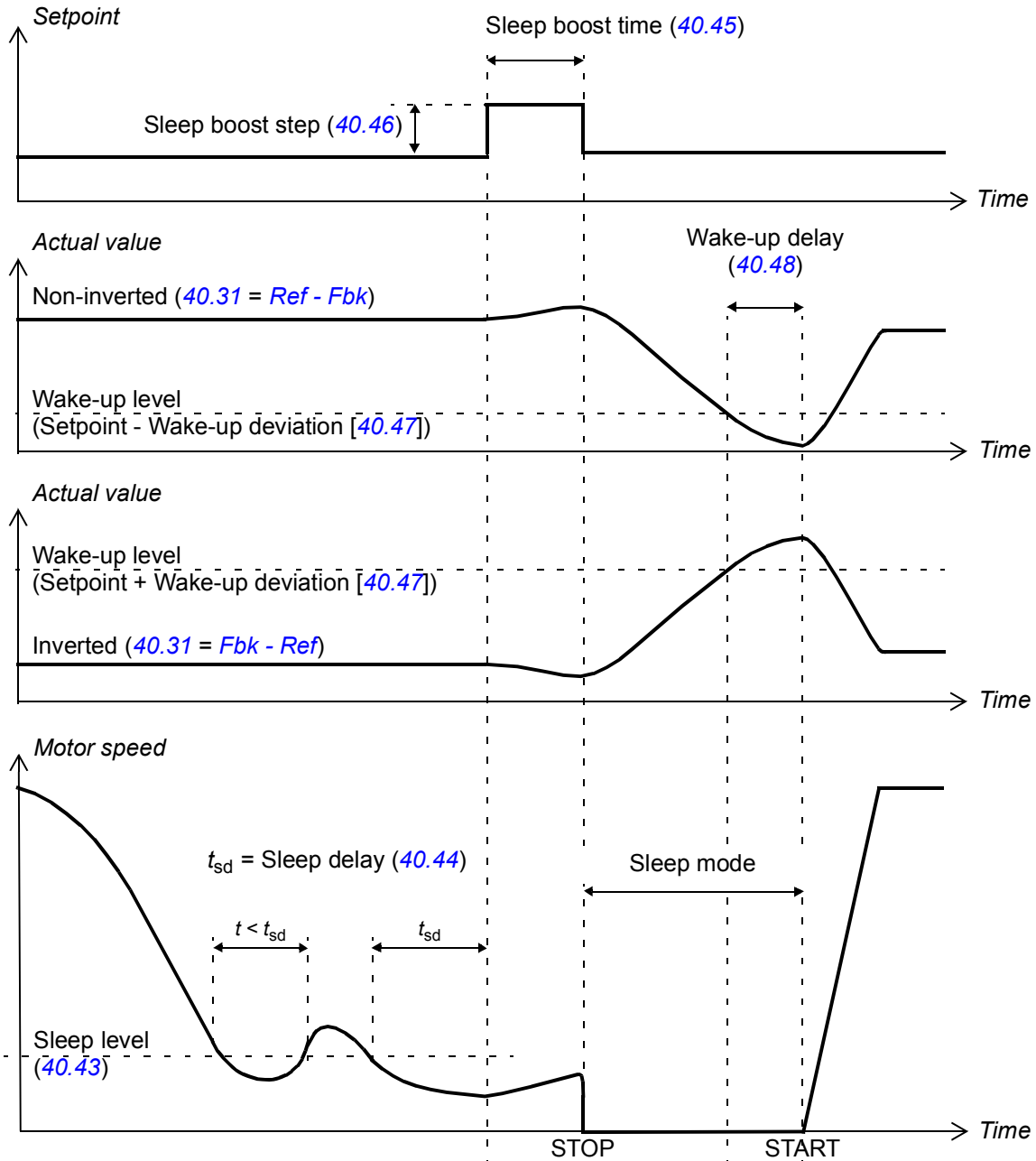

## Tracking

In tracking mode, the PID block output is set directly to the value of parameter [40.50](#) (or [41.50](#) *Tracking ref selection*). The internal I term of the PID controller is set so that no transient is allowed to pass on to the output, so when the tracking mode is left, normal process control operation can be resumed without a significant bump.

## Settings

- Parameter [96.04 Macro select](#) (macro selection)
- Parameter groups [40 Process PID set 1](#) (page [203](#)) and [41 Process PID set 2](#) (page [214](#)).

## ■ Mechanical brake control

A mechanical brake can be used for holding the motor and driven machinery at zero speed when the drive is stopped, or not powered. The brake control logic observes the settings of parameter group [44 Mechanical brake control](#) as well as several external signals, and moves between the states presented in the diagram on page [49](#). The tables below the state diagram detail the states and transitions. The timing diagram on page [51](#) shows an example of a close-open-close sequence.

### Inputs of the brake control logic

The start command of the drive (bit 5 of [06.16 Drive status word 1](#)) is the main control source of the brake control logic. An external open/close signal can optionally be selected by [44.12 Brake close request](#). The two signals interact as follows:

- Start command = 1 **AND** signal selected by [44.12 Brake close request](#) = 0  
→ Request brake to **open**
- Start command = 0 **OR** signal selected by [44.12 Brake close request](#) = 1  
→ Request brake to **close**

Another external signal – for example, from a higher-level control system – can be connected via parameter [44.11 Keep brake closed](#) to prevent the brake from opening.

Other signals that affect the state of the control logic are

- brake status acknowledgement (optional, defined by [44.07 Brake acknowledge selection](#)),
- bit 2 of [06.11 Main status word](#) (indicates whether the drive is ready to follow the given reference or not),
- bit 6 of [06.16 Drive status word 1](#) (indicates whether the drive is modulating or not),
- optional FSO-xx safety functions module.

### Outputs of the brake control logic

The mechanical brake is to be controlled by bit 0 of parameter [44.01 Brake control status](#). This bit should be selected as the source of a relay output (or a digital input/output in output mode) which is then wired to the brake actuator through a relay. See the wiring example on page [52](#).

The brake control logic, in various states, will request the drive control logic to hold the motor, increase the torque, or ramp down the speed. These requests are visible in parameter [44.01 Brake control status](#).

### Settings

Parameter group [44 Mechanical brake control](#) (page [217](#)).

---



### Brake state diagram

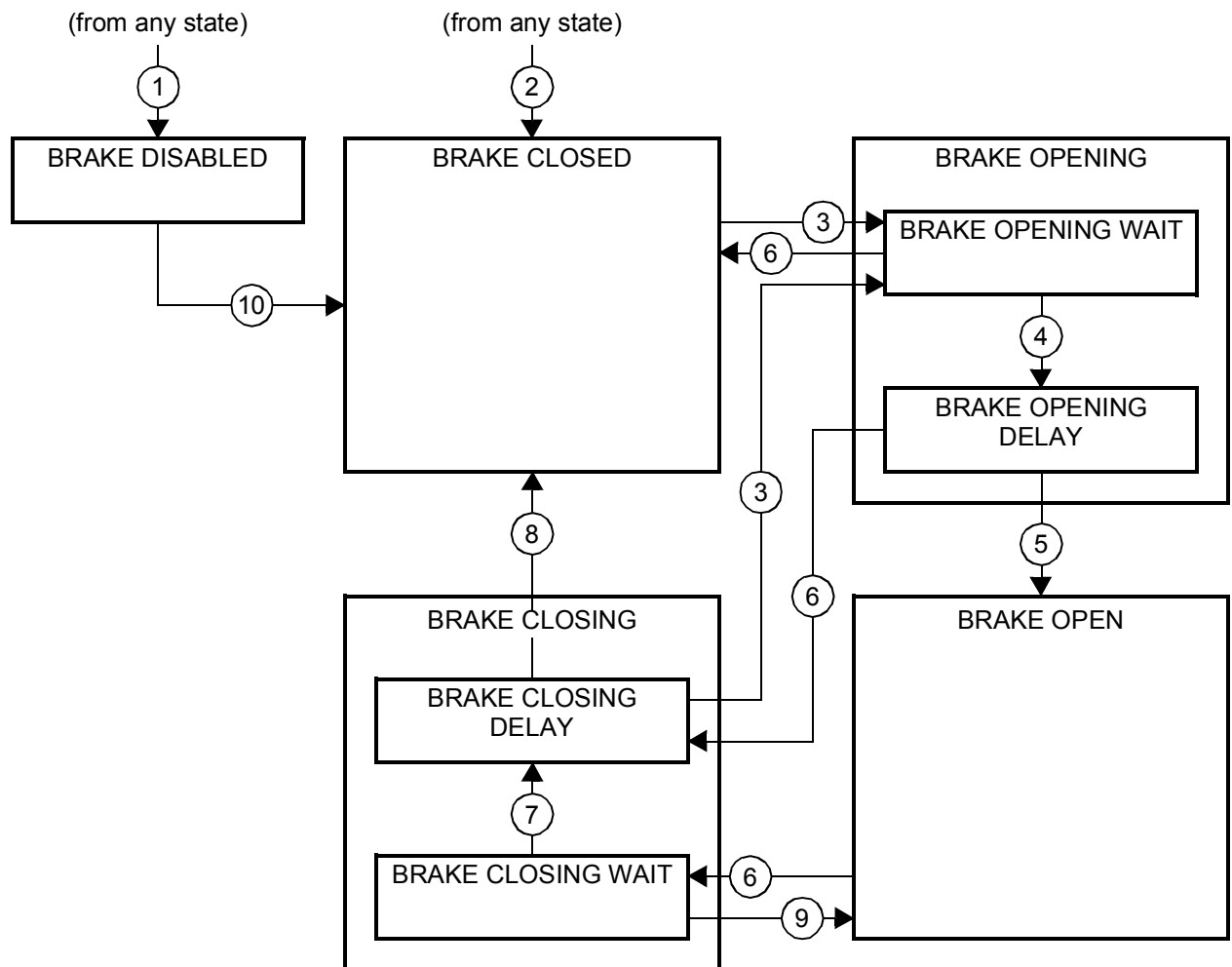

### State descriptions

State name	Description
<i>BRAKE DISABLED</i>	Brake control is disabled (parameter <i>44.06 Brake control enable</i> = 0, and <i>44.01 Brake control status</i> b4 = 0). The open signal is active ( <i>44.01 Brake control status</i> b0 = 1).
<i>BRAKE OPENING:</i>	
<i>BRAKE OPENING WAIT</i>	Brake has been requested to open. The drive logic is requested to increase the torque up to opening torque to hold the load in place ( <i>44.01 Brake control status</i> b1 = 1 and b2 = 1). The state of <i>44.11 Keep brake closed</i> is checked; if it is not 0 within a reasonable time, the drive trips on a <i>71A5 Mechanical brake opening not allowed</i> fault*.
<i>BRAKE OPENING DELAY</i>	Opening conditions have been met and open signal activated ( <i>44.01 Brake control status</i> b0 is set). The opening torque request is removed ( <i>44.01 Brake control status</i> b1 → 0). The load is held in place by the speed control of the drive until <i>44.08 Brake open delay</i> elapses. At this point, if <i>44.07 Brake acknowledge selection</i> is set to <i>No acknowledge</i> , the logic proceeds to <i>BRAKE OPEN</i> state. If an acknowledgement signal source has been selected, its state is checked; if the state is not “brake open”, the drive trips on a <i>71A3 Mechanical brake opening failed</i> fault*.
<i>BRAKE OPEN</i>	The brake is open ( <i>44.01 Brake control status</i> b0 = 1). Hold request is removed ( <i>44.01 Brake control status</i> b2 = 0), and the drive is allowed to follow the reference.

State name	Description
<b>BRAKE CLOSING:</b>	
<b>BRAKE CLOSING WAIT</b>	Brake has been requested to close. The drive logic is requested to ramp down the speed to a stop ( <i>44.01 Brake control status</i> b3 = 1). The open signal is kept active ( <i>44.01 Brake control status</i> b0 = 1). The brake logic will remain in this state until the motor speed has remained below <i>44.14 Brake close level</i> for the time defined by <i>44.15 Brake close level delay</i> .
<b>BRAKE CLOSING DELAY</b>	Closing conditions have been met. The open signal is deactivated ( <i>44.01 Brake control status</i> b0 → 0) and the closing torque written into <i>44.02 Brake torque memory</i> . The ramp-down request is maintained ( <i>44.01 Brake control status</i> b3 = 1). The brake logic will remain in this state until <i>44.13 Brake close delay</i> has elapsed. At this point, if <i>44.07 Brake acknowledge selection</i> is set to <i>No acknowledge</i> , the logic proceeds to <b>BRAKE CLOSED</b> state. If an acknowledgement signal source has been selected, its state is checked; if the state is not "brake closed", the drive generates an <i>A7A1 Mechanical brake closing failed</i> warning. If <i>44.17 Brake fault function</i> = <i>Fault</i> , the drive will trip on a <i>71A2 Mechanical brake closing failed</i> fault after <i>44.18 Brake fault delay</i> .
<b>BRAKE CLOSED</b>	The brake is closed ( <i>44.01 Brake control status</i> b0 = 0). The drive is not necessarily modulating.
*A warning can alternatively be selected by <i>44.17 Brake fault function</i> ; if so, the drive will keep modulating and remain in this state.	

### State change conditions ( $\textcircled{n}$ )

- 1 Brake control disabled (parameter *44.06 Brake control enable* → 0).
- 2 *06.11 Main status word*, bit 2 = 0 or brake is forced to close by optional FSO-xx safety functions module.
- 3 Brake has been requested to open and *44.16 Brake reopen delay* has expired.
- 4 Brake open conditions (such as *44.10 Brake open torque*) fulfilled and *44.11 Keep brake closed* = 0.
- 5 *44.08 Brake open delay* has elapsed and brake open acknowledgement (if chosen by *44.07 Brake acknowledge selection*) has been received.
- 6 Brake has been requested to close.
- 7 Motor speed has remained below closing speed *44.14 Brake close level* for the duration of *44.15 Brake close level delay*.
- 8 *44.13 Brake close delay* has elapsed and brake close acknowledgement (if chosen by *44.07 Brake acknowledge selection*) has been received.
- 9 Brake has been requested to open.
- 10 Brake control enabled (parameter *44.06 Brake control enable* → 1).

## Operation time scheme

The simplified time scheme below illustrates the operation of the brake control function. Refer to the state diagram above.

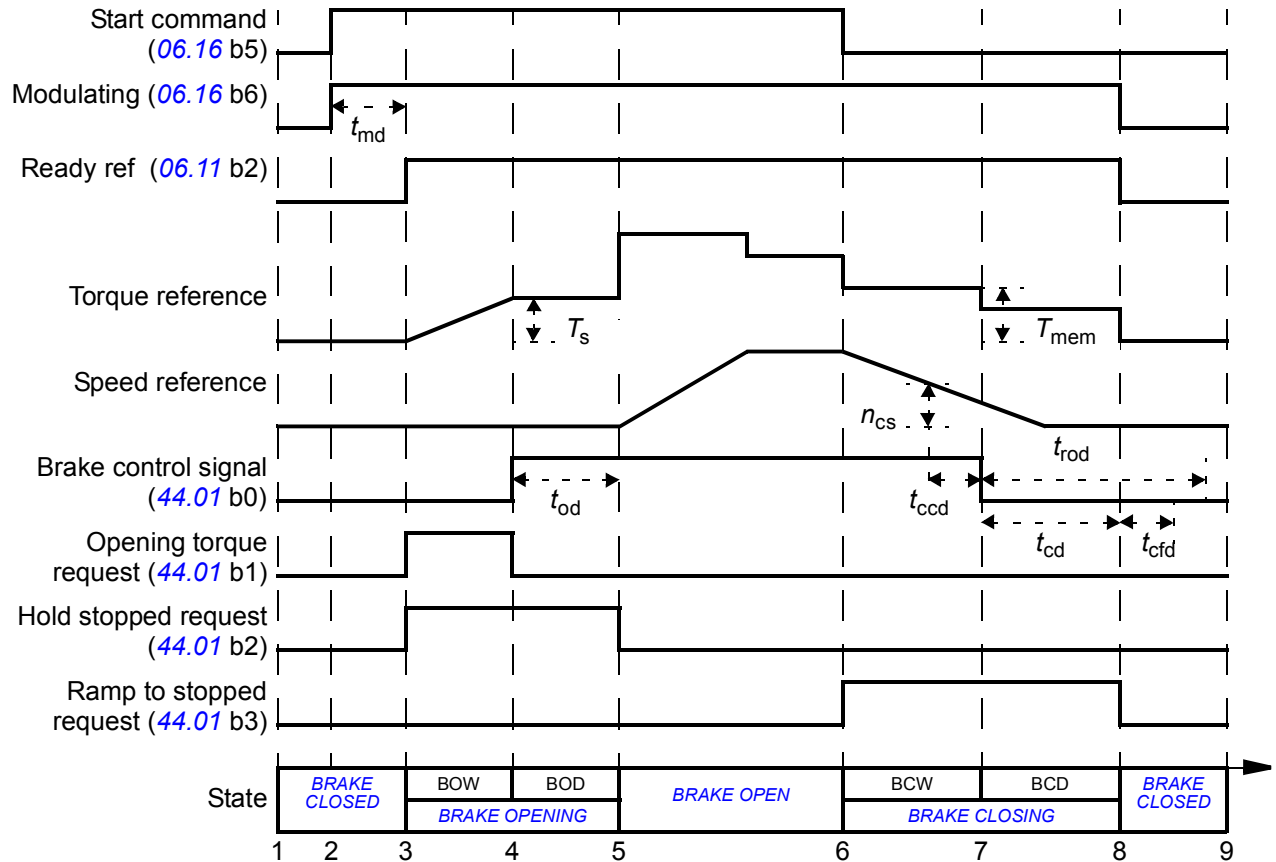

- $T_s$  Start torque at brake open (parameter 44.03 Brake open torque reference)
- $T_{mem}$  Stored torque value at brake close (44.02 Brake torque memory)
- $t_{md}$  Motor magnetization delay
- $t_{od}$  Brake open delay (parameter 44.08 Brake open delay)
- $n_{cs}$  Brake close speed (parameter 44.14 Brake close level)
- $t_{ccd}$  Brake close command delay (parameter 44.15 Brake close level delay)
- $t_{cd}$  Brake close delay (parameter 44.13 Brake close delay)
- $t_{cfd}$  Brake close fault delay (parameter 44.18 Brake fault delay)
- $t_{rod}$  Brake reopen delay (parameter 44.16 Brake reopen delay)
- BOW BRAKE OPENING WAIT
- BOD BRAKE OPENING DELAY
- BCW BRAKE CLOSING WAIT
- BCD BRAKE CLOSING DELAY

## Wiring example

The figure below shows a brake control wiring example. The brake control hardware and wiring is to be sourced and installed by the customer.



**WARNING!** Make sure that the machinery into which the drive with brake control function is integrated fulfils the personnel safety regulations. Note that the frequency converter (a Complete Drive Module or a Basic Drive Module, as defined in IEC 61800-2), is not considered as a safety device mentioned in the European Machinery Directive and related harmonised standards. Thus, the personnel safety of the complete machinery must not be based on a specific frequency converter feature (such as the brake control function), but it has to be implemented as defined in the application specific regulations.

The brake is controlled by bit 0 of parameter [44.01 Brake control status](#). The source of brake acknowledge (status supervision) is selected by parameter [44.07 Brake acknowledge selection](#). In this example,

- parameter [10.24 RO1 source](#) is set to [Brake command](#) (ie. bit 0 of [44.01 Brake control status](#)), and
- parameter [44.07 Brake acknowledge selection](#) is set to [DI5](#).

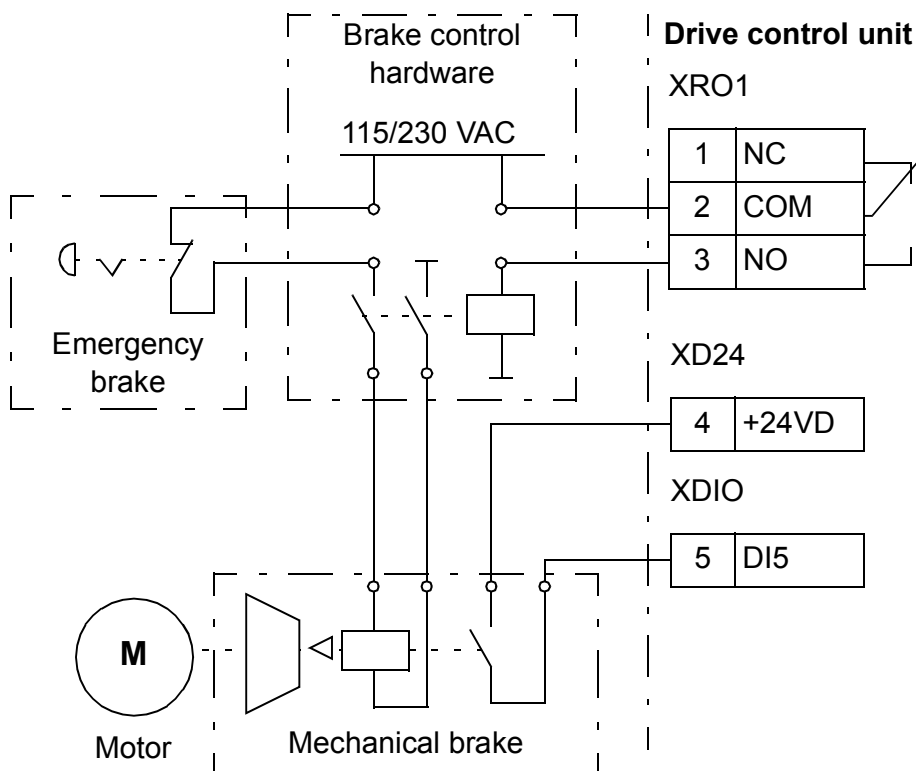

## DC voltage control

### ■ Overvoltage control

Overvoltage control of the intermediate DC link is typically needed when the motor is in generating mode. To prevent the DC voltage from exceeding the overvoltage control limit, the overvoltage controller automatically decreases the generating torque when the limit is reached.

### ■ Undervoltage control

If the incoming supply voltage is cut off, the drive will continue to operate by utilizing the kinetic energy of the rotating motor. The drive will be fully operational as long as the motor rotates and generates energy to the drive. The drive can continue operation after the break if the main contactor (if present) remained closed.

**Note:** Units equipped with a main contactor must be equipped with a hold circuit (e.g. UPS) to keep the contactor control circuit closed during a short supply break.

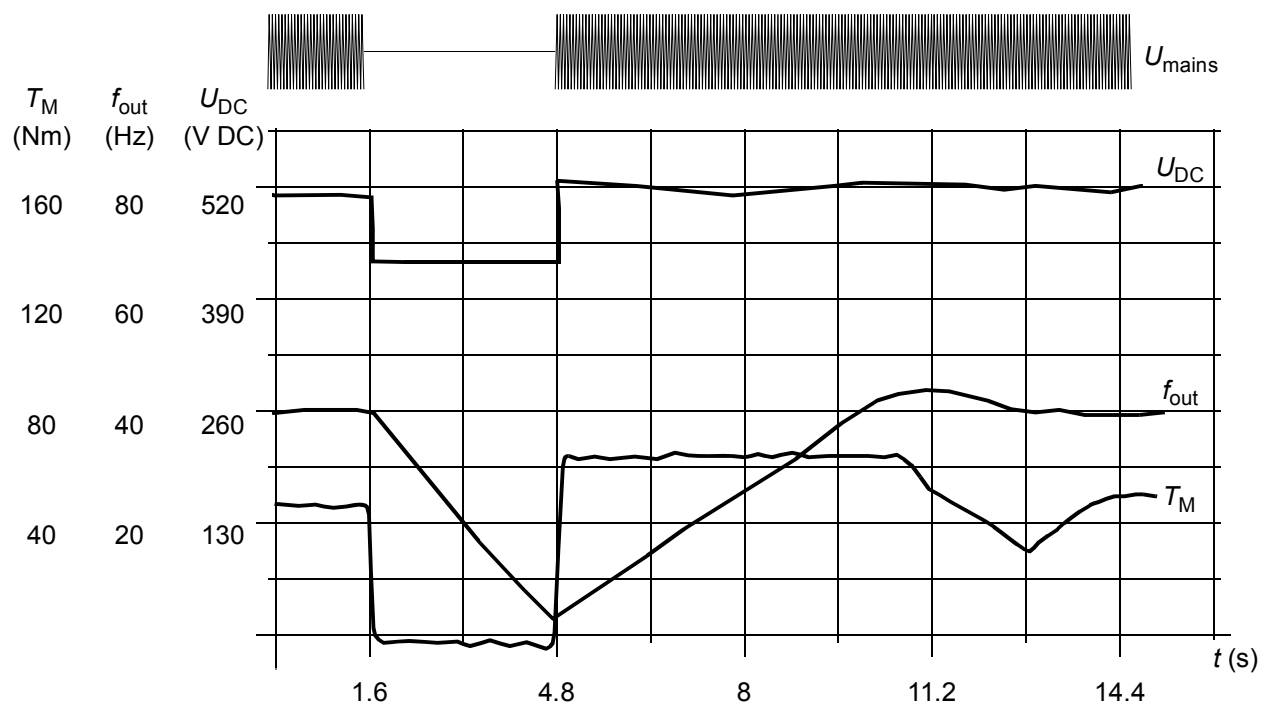

$U_{DC}$  = intermediate circuit voltage of the drive,  $f_{out}$  = output frequency of the drive,  $T_M$  = motor torque  
 Loss of supply voltage at nominal load ( $f_{out} = 40$  Hz). The intermediate circuit DC voltage drops to the minimum limit. The controller keeps the voltage steady as long as the mains is switched off. The drive runs the motor in generator mode. The motor speed falls but the drive is operational as long as the motor has enough kinetic energy.

## Automatic restart

It is possible to restart the drive automatically after a short (max. 5 seconds) power supply failure by using the Automatic restart function provided that the drive is allowed to run for 5 seconds without the cooling fans operating.

When enabled, the function takes the following actions upon a supply failure to enable a successful restart:

- The undervoltage fault is suppressed (but a warning is generated)
- Modulation and cooling is stopped to conserve any remaining energy
- DC circuit pre-charging is enabled.

If the DC voltage is restored before the expiration of the period defined by parameter [21.18 Auto restart time](#) and the start signal is still on, normal operation will continue. However, if the DC voltage remains too low at that point, the drive trips on a fault, [3280 Standby timeout](#).

## ■ Voltage control and trip limits

The control and trip limits of the intermediate DC voltage regulator are relative to the supply voltage as well as drive/inverter type. The DC voltage ( $U_{DC}$ ) is approximately 1.35 times the line-to-line supply voltage, and is displayed by parameter [01.11 DC voltage](#).

The following diagram shows the relation of selected DC voltage levels. Note that the absolute voltages vary according to drive/inverter type and AC supply voltage range.

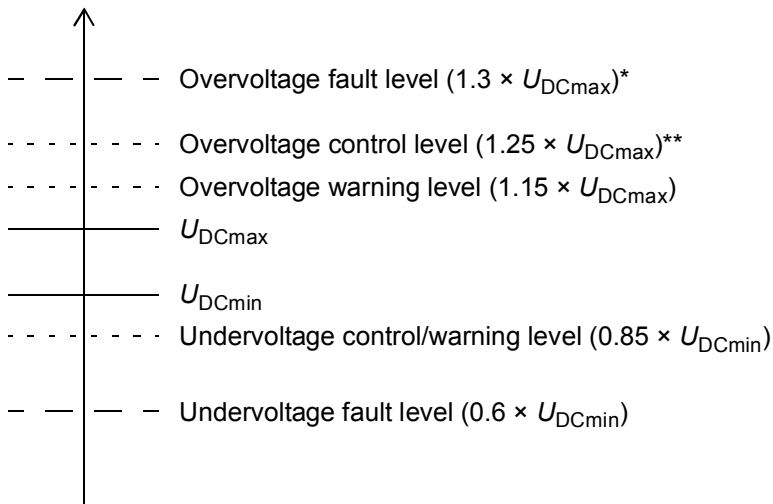

$U_{DCmax}$  = DC voltage corresponding to the maximum of the AC supply voltage range

$U_{DCmin}$  = DC voltage corresponding to the minimum of the AC supply voltage range

\* For 500 V AC supply voltage range,  $1.25 \times U_{DCmax}$ .

\*\* For 500 V AC supply voltage range,  $1.20 \times U_{DCmax}$ .

## Settings

Parameters [01.11 DC voltage](#) (page 84), [30.30 Overvoltage control](#) (page 177), [30.31 Undervoltage control](#) (page 177) and [95.01 Supply voltage](#) (page 257).

### ■ Brake chopper

A brake chopper can be used to handle the energy generated by a decelerating motor. When the DC voltage rises high enough, the chopper connects the DC circuit to an external brake resistor. The chopper operates on the pulse width modulation principle.

The internal brake choppers of ACS880 drives start conducting when the DC link voltage reaches approximately  $1.15 \times U_{DCmax}$ . 100% pulse width is reached at approximately  $1.2 \times U_{DCmax}$ . ( $U_{DCmax}$  is the DC voltage corresponding to the maximum of the AC supply voltage range.)

For information on external brake choppers, refer to their documentation.

## Settings

Parameter [01.11 DC voltage](#) (page 84); parameter group [43 Brake chopper](#) (page 215).

---

## Safety and protections

### ■ Emergency stop

The emergency stop signal is connected to the input selected by parameter [21.05 Emergency stop source](#). The mode of the emergency stop is selected by parameter [21.04 Emergency stop mode](#). An emergency stop can also be generated through a fieldbus (parameter [06.01 Main control word](#), bits 0...2).

#### Notes:

- The installer of the equipment is responsible for installing the emergency stop devices and all additional devices needed for the emergency stop function to fulfill the required emergency stop categories. For more information, contact your local ABB representative.
- After an emergency stop signal is detected, the emergency stop function cannot be canceled even though the signal is canceled.
- If the minimum (or maximum) torque limit is set to 0%, the emergency stop function may not be able to stop the drive.

### ■ Motor thermal protection

The control program features two separate motor temperature monitoring functions. The temperature data sources and warning/trip limits can be set up independently for each function.

The motor temperature can be monitored using

- the motor thermal protection model (estimated temperature), or
- sensors installed in the windings. This will result in a more accurate motor model.

#### Motor thermal protection model

The drive calculates the temperature of the motor on the basis of the following assumptions:

1. When power is applied to the drive for the first time, the motor is at ambient temperature (defined by parameter [35.50 Motor ambient temperature](#)). After this, when power is applied to the drive, the motor is assumed to be at the estimated temperature.
2. Motor temperature is calculated using the user-adjustable motor thermal time and motor load curve. The load curve should be adjusted in case the ambient temperature exceeds 30 °C.

**Note:** The motor thermal model can be used when only one motor is connected to the inverter.

---



## Temperature monitoring using PTC sensors

One PTC sensor can be connected to digital input DI6. FEN-xx encoder interfaces (optional) also have a connection for one PTC sensor.

Connecting a PTC sensor to DI6 requires a voltage divider circuit such as the one pictured below.

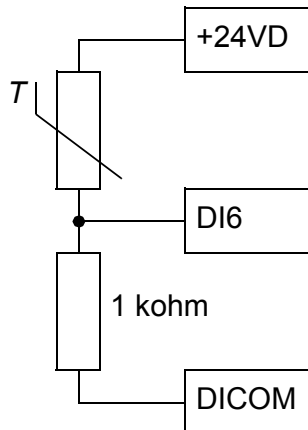

The resistance of a PTC sensor increases when its temperature rises. The increasing resistance of the sensor decreases the voltage over the 1 kohm resistor, and eventually the state of DI6 switches from 1 to 0, indicating overtemperature.

The figure below shows typical PTC sensor resistance values as a function of temperature.

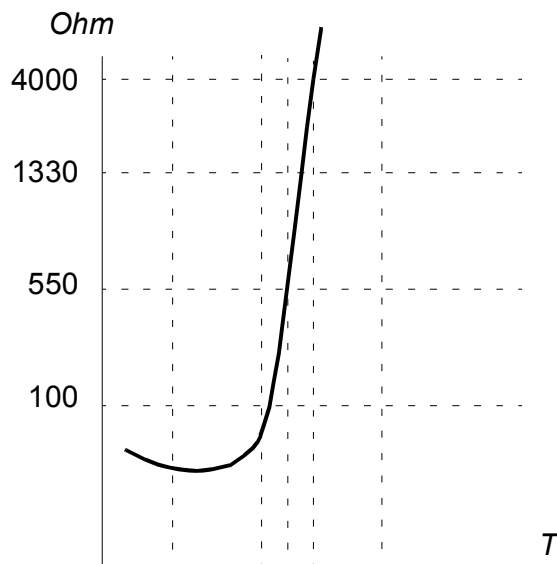

For detailed wiring information, refer to the *Hardware Manual* of the drive, or the *User manual* of the FEN-xx encoder interface.

## Temperature monitoring using Pt100 sensors

1...3 Pt100 sensors can be connected in series to an analog input and an analog output.

The analog output feeds a constant excitation current of 9.1 mA through the sensor. The sensor resistance increases as the motor temperature rises, as does the voltage over the sensor. The temperature measurement function reads the voltage through the analog input and converts it into degrees Celsius.

It is possible to adjust the motor temperature supervision limits and select how the drive reacts when overtemperature is detected.

For the wiring of the sensor, refer to the *Hardware Manual* of the drive.

### Temperature monitoring using KTY84 sensors

One KTY84 sensor can be connected to an analog input and an analog output on the control unit.

The analog output feeds a constant excitation current of 2.0 mA through the sensor. The sensor resistance increases as the motor temperature rises, as does the voltage over the sensor. The temperature measurement function reads the voltage through the analog input and converts it into degrees Celsius.

FEN-xx encoder interfaces (optional) also have a connection for one KTY84 sensor.

The figure and table below show typical KTY84 sensor resistance values as a function of the motor operating temperature.

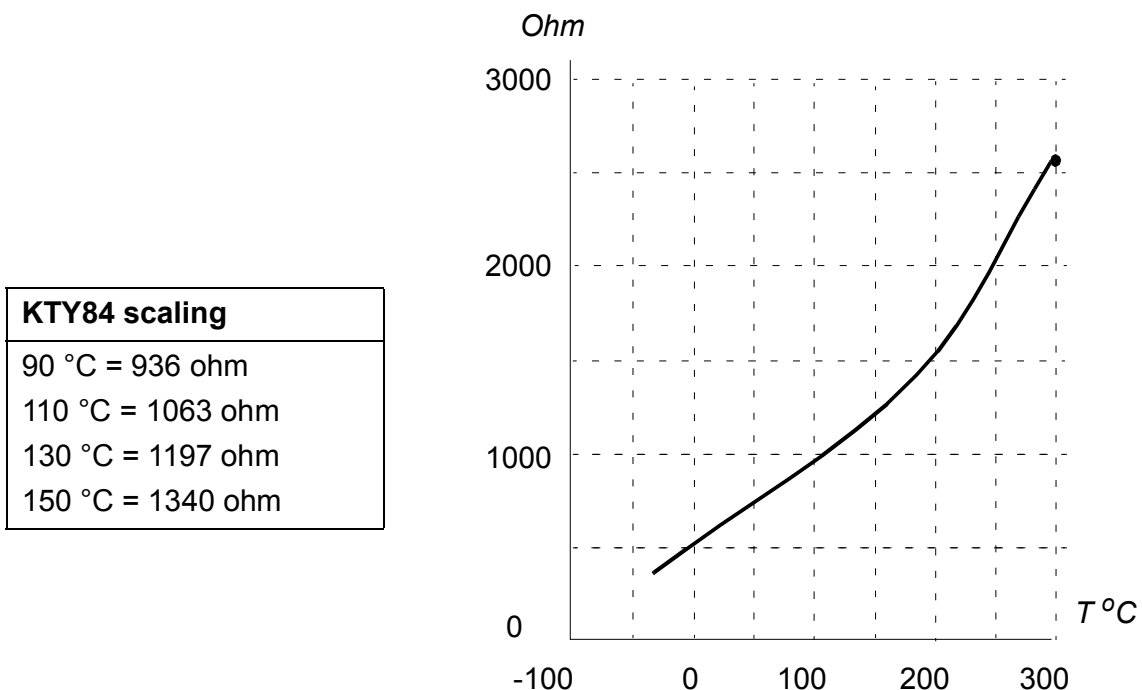

It is possible to adjust the motor temperature supervision limits and select how the drive reacts when overtemperature is detected.

For the wiring of the sensor, refer to the *Hardware Manual* of the drive.

## Settings

Parameter group [35 Motor thermal protection](#) (page 193) and [91 Encoder module settings](#) (page 248).

### ■ Programmable protection functions

#### External events (parameters [31.01...31.10](#))

External event signals can be connected to selectable inputs. When the signal is lost, an external event (fault, warning, or a mere log entry) is generated. The contents of the message can be edited on the control panel by selecting **Settings - Edit texts**.

#### Motor phase loss detection (parameter [31.19](#))

The parameter selects how the drive reacts whenever a motor phase loss is detected.

#### Earth fault detection (parameter [31.20](#))

The earth fault detection function is based on sum current measurement. Note that

- an earth fault in the supply cable does not activate the protection
- in a grounded supply, the protection activates in 200 milliseconds
- in an ungrounded supply, the supply capacitance should be 1 microfarad or more
- the capacitive currents caused by shielded motor cables up to 300 meters will not activate the protection
- the protection is deactivated when the drive is stopped.

#### Supply phase loss detection (parameter [31.21](#))

The parameter selects how the drive reacts whenever a supply phase loss is detected.

#### Safe torque off detection (parameter [31.22](#))

The drive monitors the status of the Safe torque off input, and this parameter selects which indications are given when the signals are lost. (The parameter does not affect the operation of the Safe torque off function itself). For more information on the Safe torque off function, see the *Hardware manual*.

#### Switched supply and motor cabling (parameter [31.23](#))

The drive can detect if the supply and motor cables have accidentally been switched (for example, if the supply is connected to the motor connection of the drive). The parameter selects if a fault is generated or not.

#### Stall protection (parameters [31.24...31.28](#))

The drive protects the motor in a stall situation. It is possible to adjust the supervision limits (current, frequency and time) and choose how the drive reacts to a motor stall condition.

---

### **Overspeed protection (parameter [31.30](#))**

The user can set overspeed limits by specifying a margin that is added to the currently-used maximum and minimum speed limits.

### **Local control loss detection (parameter [49.05](#))**

The parameter selects how the drive reacts to a control panel or PC tool communication break.

### **■ Automatic fault resets**

The drive can automatically reset itself after overcurrent, overvoltage, undervoltage and external faults. The user can also specify a fault that is automatically reset.

By default, automatic resets are off and must be specifically activated by the user.

### **Settings**

Parameters [31.12](#)...[31.16](#) (page [179](#)).

---

## Diagnostics

### ■ Signal supervision

Three signals can be selected to be supervised by this function. Whenever a supervised signal exceeds or falls below predefined limits, a bit in [32.01 Supervision status](#) is activated, and a warning or fault generated. The contents of the message can be edited on the control panel by selecting **Settings - Edit texts**.

The supervised signal is low-pass filtered.

### Settings

Parameter group [32 Supervision](#) (page [183](#)).

### ■ Maintenance timers and counters

The program has six different maintenance timers or counters that can be configured to generate a warning when a pre-defined limit is reached. The contents of the message can be edited on the control panel by selecting **Settings - Edit texts**.

The timer/counter can be set to monitor any parameter. This feature is especially useful as a service reminder.

There are three types of counters:

- On-time timers. Measures the time a binary source (for example, a bit in a status word) is on.
- Signal edge counters. The counter is incremented whenever the monitored binary source changes state.
- Value counters. The counter measures, by integration, the monitored parameter. An alarm is given when the calculated area below the signal peak exceeds a user-defined limit.

### Settings

Parameter group [33 Maintenance timer & counter](#) (page [187](#)).

### ■ Energy savings calculator

This feature consists of the following functionalities:

- An energy optimizer that adjusts the motor flux in such a way that the total efficiency is maximized
  - A counter that monitors used and saved energy by the motor and displays them in kWh, currency or volume of CO<sub>2</sub> emissions, and
  - A load analyzer showing the load profile of the drive (see separate section on page [62](#)).
-

**Note:** The accuracy of the energy savings calculation is directly dependent on the accuracy of the reference motor power given in parameter [45.19 Comparison power](#).

## Settings

Parameter group [45 Energy efficiency](#) (page [221](#)).

### ■ Load analyzer

#### Peak value logger

The user can select a signal to be monitored by a peak value logger. The logger records the peak value of the signal along with the time the peak occurred, as well as motor current, DC voltage and motor speed at the time of the peak.

#### Amplitude loggers

The control program has two amplitude loggers.

For amplitude logger 2, the user can select a signal to be sampled at 200 ms intervals when the drive is running, and specify a value that corresponds to 100%. The collected samples are sorted into 10 read-only parameters according to their amplitude. Each parameter represents an amplitude range 10 percentage points wide, and displays the percentage of the collected samples that fall within that range.

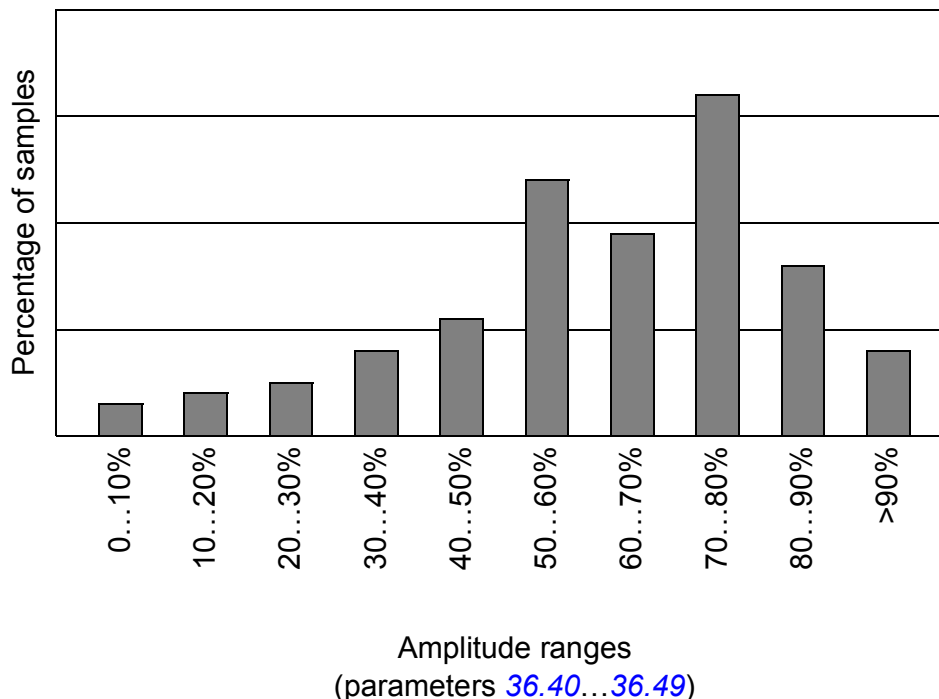

Amplitude logger 1 is fixed to monitor motor current, and cannot be reset. With amplitude logger 1, 100% corresponds to the maximum output current of the drive ( $I_{\max}$ ). The distribution of samples is shown by parameters [36.20](#)...[36.29](#).

## Settings

Parameter group [36 Load analyzer](#) (page [200](#)).

## Miscellaneous

### ■ User parameter sets

The drive supports four user parameter sets that can be saved to the permanent memory and recalled using drive parameters. It is also possible to use digital inputs to switch between user parameter sets.

A user parameter set contains all editable values in parameter groups 10...99 except

- I/O extension module settings (groups 14...16)
- data storage parameters (group 47)
- fieldbus adapter-specific settings (groups 51...56), and
- encoder settings (groups 90...93).

As the motor settings are included in the user parameter sets, make sure the settings correspond to the motor used in the application before recalling a user set. In an application where different motors are used with the drive, the motor ID run needs to be performed with each motor and the results saved to different user sets. The appropriate set can then be recalled when the motor is switched.

### Settings

Parameters [96.10](#)...[96.13](#) (page [260](#)).

### ■ Data storage parameters

Twenty-four (sixteen 32-bit, eight 16-bit) parameters are reserved for data storage. These parameters are unconnected by default and can be used for linking, testing and commissioning purposes. They can be written to and read from using other parameters' source or target selections.

### Settings

Parameter group [47 Data storage](#) (page [225](#)).

---



5

# Application macros

---

## What this chapter contains

This chapter describes the intended use, operation and default control connections of the application macros.

More information on the connectivity of the control unit is given in the *Hardware manual* of the drive.

## General

Application macros are sets of default parameter values suitable for the application in question. When starting up the drive, the user typically selects the best-suited application macro as a basis and makes the necessary changes and saves the result as a user parameter set.

Application macros can be selected by parameter [96.04 Macro select](#). User parameter sets are managed by the parameters in group [96 System](#).

---

## Factory macro

The Factory macro is suited to relatively straightforward speed control applications such as conveyors, pumps and fans, and test benches.

In external control, the control location is EXT1. The drive is speed-controlled with the reference signal connected to analog input AI1. The start/stop commands are given through digital input DI1; running direction is determined by DI2.

Faults are reset through digital input DI3.

DI4 switches between acceleration/deceleration time sets 1 and 2. The acceleration and deceleration times, as well as ramp shapes, are defined by parameters [23.12...23.19](#).

DI5 activates constant speed 1.

### ■ **Default parameter settings for the Factory macro**

The default parameter settings for the Factory macro are listed under [Parameter listing](#) (page [84](#)).

---

■ Default control connections for the Factory macro

<b>XPOW</b> External power input		
1	+24VI	24 V DC, 2 A
2	GND	
<b>XAI</b> Reference voltage and analog inputs		
1	+VREF	10 V DC, $R_L$ 1...10 kohm
2	-VREF	-10 V DC, $R_L$ 1...10 kohm
3	AGND	Ground
4	AI1+	<b>Speed reference</b>
5	AI1-	0(2)...10 V, $R_{in} > 200$ kohm
6	AI2+	By default not in use.
7	AI2-	0(4)...20 mA, $R_{in} > 100$ ohm
<b>XAO</b> Analog outputs		
1	AO1	<b>Motor speed rpm</b>
2	AGND	0...20 mA, $R_L < 500$ ohm
3	AO2	<b>Motor current</b>
4	AGND	0...20 mA, $R_L < 500$ ohm
<b>XD2D</b> Drive-to-drive link		
1	B	Drive-to-drive link
2	A	
3	BGND	
<b>XRO1, XRO2, XRO3</b> Relay outputs		
1	NC	<b>Ready</b> 250 V AC / 30 V DC 2 A
2	COM	
3	NO	
1	NC	<b>Running</b> 250 V AC / 30 V DC 2 A
2	COM	
3	NO	
1	NC	<b>Faulted(-1)</b> 250 V AC / 30 V DC 2 A
2	COM	
3	NO	
<b>XD24</b> Digital interlock		
1	DIIL	Digital interlock. By default, not in use.
2	+24VD	+24 V DC 200 mA
3	DICOM	Digital input ground
4	+24VD	+24 V DC 200 mA
5	DIOGND	Digital input/output ground
<b>XDIO</b> Digital input/outputs		
1	DIO1	Output: Ready
2	DIO2	Output: Running
<b>XDI</b> Digital inputs		
1	DI1	Stop (0) / Start (1)
2	DI2	Forward (0) / Reverse (1)
3	DI3	Reset
4	DI4	Acc/Dec time set 1 (0) / set 2 (1)
5	DI5	Constant speed 1 (1 = On)
6	DI6	By default, not in use.
<b>XSTO</b>	Safe torque off circuits must be closed for the drive to start. See <i>Hardware manual</i> of drive.	
<b>X12</b>	Safety options connection	
<b>X13</b>	Control panel connection	
<b>X205</b>	Memory unit connection	

## Hand/Auto macro

The Hand/Auto macro is suited to speed control applications where two external control devices are used.

The drive is speed-controlled from the external control locations EXT1 (Hand control) and EXT2 (Auto control). The selection between the control locations is done through digital input DI3.

The start/stop signal for EXT1 is connected to DI1 while running direction is determined by DI2. For EXT2, start/stop commands are given through DI6, the direction through DI5.

The reference signals for EXT1 and EXT2 are connected to analog inputs AI1 and AI2 respectively.



A constant speed (by default, 300 rpm) can be activated through DI4.

### ■ Default parameter settings for the Hand/Auto macro

Below is a listing of default parameter values that differ from those listed for the Factory macro in [Parameter listing](#) (page 84).

Parameter		Hand/Auto macro default
No.	Name	
12.30	<i>AI2 scaled at AI2 max</i>	1500.000
19.11	<i>Ext1/Ext2 selection</i>	<i>DI3</i>
20.06	<i>Ext2 commands</i>	<i>In1 Start; In2 Dir</i>
20.08	<i>Ext2 in1</i>	<i>DI6</i>
20.09	<i>Ext2 in2</i>	<i>DI5</i>
22.12	<i>Speed ref2 selection</i>	<i>AI2 scaled</i>
22.14	<i>Speed ref1/2 selection</i>	<i>MCW bit11: Ext ctrl loc</i>
22.22	<i>Constant speed sel1</i>	<i>DI4</i>
23.11	<i>Ramp set selection</i>	<i>Acc/Dec time 1</i>
31.11	<i>Fault reset selection</i>	<i>Off</i>

■ Default control connections for the Hand/Auto macro

<b>XPOW</b> External power input		
1	+24VI	24 V DC, 2 A
2	GND	
<b>XAI</b> Reference voltage and analog inputs		
1	+VREF	10 V DC, $R_L$ 1...10 kohm
2	-VREF	-10 V DC, $R_L$ 1...10 kohm
3	AGND	Ground
4	AI1+	<b>Speed reference (Hand)</b>
5	AI1-	0(2)...10 V, $R_{in} > 200$ kohm
6	AI2+	<b>Speed reference (Auto)</b>
7	AI2-	0(4)...20 mA, $R_{in} > 100$ ohm
<b>XAO</b> Analog outputs		
1	AO1	<b>Motor speed rpm</b>
2	AGND	0...20 mA, $R_L < 500$ ohm
3	AO2	<b>Motor current</b>
4	AGND	0...20 mA, $R_L < 500$ ohm
<b>XD2D</b> Drive-to-drive link		
1	B	Drive-to-drive link
2	A	
3	BGND	
<b>XRO1, XRO2, XRO3</b> Relay outputs		
1	NC	 <b>Ready</b> 250 V AC / 30 V DC 2 A
2	COM	
3	NO	
1	NC	 <b>Running</b> 250 V AC / 30 V DC 2 A
2	COM	
3	NO	
1	NC	 <b>Faulted(-1)</b> 250 V AC / 30 V DC 2 A
2	COM	
3	NO	
<b>XD24</b> Digital interlock		
1	DIIL	Digital interlock. By default, not in use.
2	+24VD	+24 V DC 200 mA
3	DICOM	Digital input ground
4	+24VD	+24 V DC 200 mA
5	DIOGND	Digital input/output ground
<b>XDIO</b> Digital input/outputs		
1	DIO1	Output: Ready
2	DIO2	Output: Running
<b>XDI</b> Digital inputs		
1	DI1	Stop (0) / Start (1) – Hand
2	DI2	Forward (0) / Reverse (1) – Hand
3	DI3	Hand (0) / Auto (1)
4	DI4	Constant speed 1 (1 = On)
5	DI5	Forward (0) / Reverse (1) – Auto
6	DI6	Stop (0) / Start (1) – Auto
<b>XSTO</b>	Safe torque off circuits must be closed for the drive to start. See <i>Hardware manual</i> of drive.	
<b>X12</b>	Safety options connection	
<b>X13</b>	Control panel connection	
<b>X205</b>	Memory unit connection	

## **PID control macro**

The PID control macro is suitable for process control applications, for example closed-loop pressure, level or flow control systems such as

- pressure boost pumps of municipal water supply systems
- level-controlling pumps of water reservoirs
- pressure boost pumps of district heating systems
- material flow control on a conveyor line.

The process reference signal is connected to analog input AI1 and the process feedback signal to AI2. Alternatively, a direct speed reference can be given to the drive through AI1. Then the PID controller is bypassed and the drive no longer controls the process variable.

Selection between direct speed control (control location EXT1) and process variable control (EXT2) is done through digital input DI3.

The stop/start signals for EXT1 and EXT2 are connected to DI1 and DI6 respectively.

A constant speed (by default, 300 rpm) can be activated through DI4.



---

## ■ Default parameter settings for the PID control macro

Below is a listing of default parameter values that differ from those listed for the Factory macro in [Parameter listing](#) (page 84).

Parameter		PID control macro default
No.	Name	
12.30	<i>AI2 scaled at AI2 max</i>	1500.000
19.11	<i>Ext1/Ext2 selection</i>	<i>DI3</i>
20.01	<i>Ext1 commands</i>	<i>In1 Start</i>
20.04	<i>Ext1 in2</i>	<i>Off</i>
20.06	<i>Ext2 commands</i>	<i>In1 Start</i>
20.08	<i>Ext2 in1</i>	<i>DI6</i>
20.12	<i>Run enable 1</i>	<i>DI5</i>
22.12	<i>Speed ref2 selection</i>	<i>PID</i>
22.14	<i>Speed ref1/2 selection</i>	<i>MCW bit11: Ext ctrl loc</i>
22.22	<i>Constant speed sel1</i>	<i>DI4</i>
23.11	<i>Ramp set selection</i>	<i>Acc/Dec time 1</i>
31.11	<i>Fault reset selection</i>	<i>Off</i>
40.07	<i>PID operation mode</i>	<i>On</i>
40.08	<i>Feedback 1 source</i>	<i>AI2 scaled</i>
40.11	<i>Feedback filter time</i>	0.040 s
40.16	<i>Setpoint 1 source</i>	<i>AI1 scaled</i>
40.35	<i>Derivation filter time</i>	1.0 s

## Default control connections for the PID control macro

<b>XPOW</b> External power input		
1	+24VI	24 V DC, 2 A
2	GND	
<b>XAI</b> Reference voltage and analog inputs		
1	+VREF	10 V DC, $R_L$ 1...10 kohm
2	-VREF	-10 V DC, $R_L$ 1...10 kohm
3	AGND	Ground
4	AI1+	<b>Process or Speed reference</b>
5	AI1-	0(2)...10 V, $R_{in} > 200$ kohm
6	AI2+	<b>Process feedback*</b>
7	AI2-	0(4)...20 mA, $R_{in} > 100$ ohm
<b>XAO</b> Analog outputs		
1	AO1	<b>Motor speed rpm</b>
2	AGND	0...20 mA, $R_L < 500$ ohm
3	AO2	<b>Motor current</b>
4	AGND	0...20 mA, $R_L < 500$ ohm
<b>XD2D</b> Drive-to-drive link		
1	B	Drive-to-drive link
2	A	
3	BGND	
<b>XRO1, XRO2, XRO3</b> Relay outputs		
1	NC	 <b>Ready</b> 250 V AC / 30 V DC 2 A
2	COM	
3	NO	
1	NC	 <b>Running</b> 250 V AC / 30 V DC 2 A
2	COM	
3	NO	
1	NC	 <b>Faulted(-1)</b> 250 V AC / 30 V DC 2 A
2	COM	
3	NO	
<b>XD24</b> Digital interlock		
1	DIIL	Digital interlock. By default, not in use.
2	+24VD	+24 V DC 200 mA
3	DICOM	Digital input ground
4	+24VD	+24 V DC 200 mA
5	DIOGND	Digital input/output ground
<b>XDIO</b> Digital input/outputs		
1	DIO1	Output: Ready
2	DIO2	Output: Running
<b>XDI</b> Digital inputs		
1	DI1	Stop (0) / Start (1) – Speed control
2	DI2	By default, not in use.
3	DI3	Speed control (0) / Process control (1)
4	DI4	Constant speed 1 (1 = On)
5	DI5	By default, not in use.
6	DI6	Stop (0) / Start (1) – Process control
<b>XSTO</b>	Safe torque off circuits must be closed for the drive to start. See <i>Hardware manual</i> of drive.	
<b>X12</b>	Safety options connection	
<b>X13</b>	Control panel connection	
<b>X205</b>	Memory unit connection	

\*For sensor connection examples, see page 73.



■ Sensor connection examples

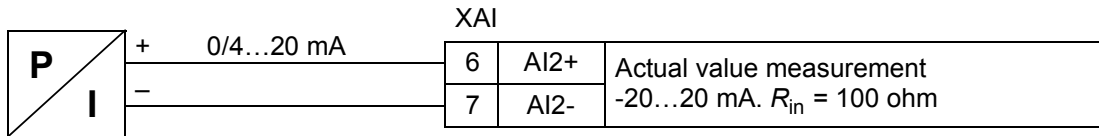

Note: The sensor must be powered externally.

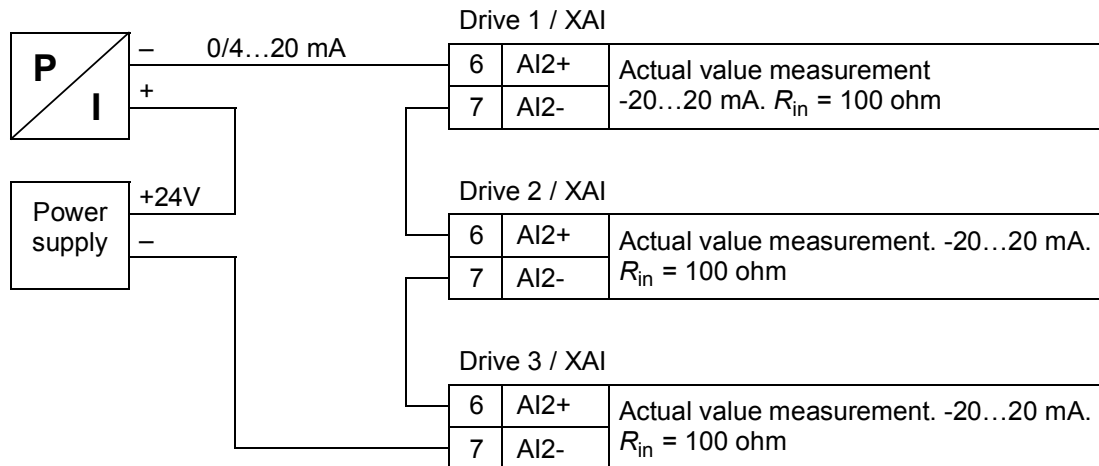
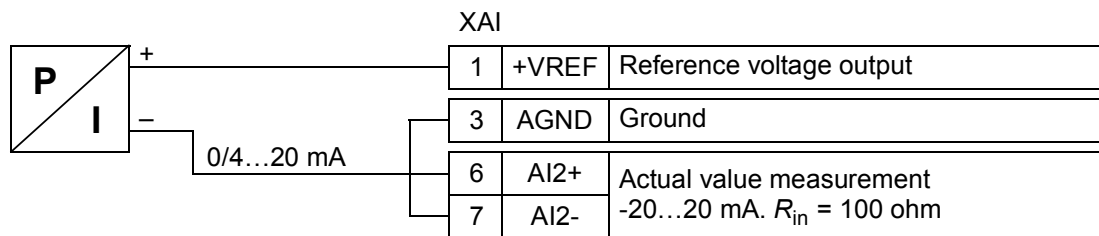
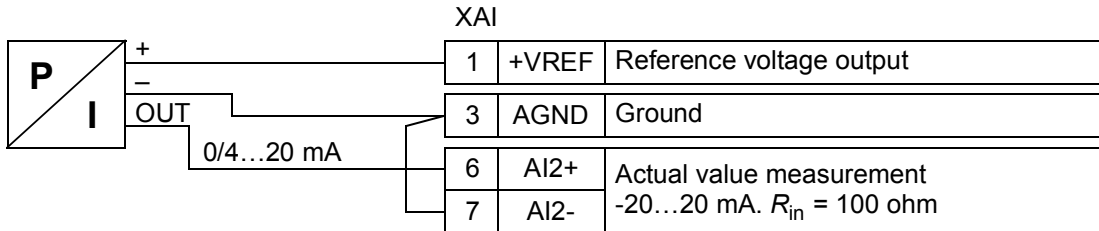

## Torque control macro

This macro is used in applications in which torque control of the motor is required. Torque reference is given through analog input AI2, typically as a current signal in the range of 0...20 mA (corresponding to 0...100% of rated motor torque).

The start/stop signal is connected to digital input DI1. The direction is determined by DI2.

Through digital input DI3, it is possible to select speed control instead of torque control. It is also possible to change the control to local (control panel or PC tool) by pressing the Loc/Rem key. By default, the local reference is speed; if a torque reference is required, the value of parameter [19.16 Local control mode](#) should be changed to *Torque*.



A constant speed (by default, 300 rpm) can be activated through DI4. DI5 switches between acceleration/deceleration time sets 1 and 2. The acceleration and deceleration times, as well as ramp shapes, are defined by parameters [23.12...23.19](#).

### ■ Default parameter settings for the Torque control macro

Below is a listing of default parameter values that differ from those listed for the Factory macro in [Parameter listing](#) (page 84).

Parameter		Torque control macro default
No.	Name	
<a href="#">19.11</a>	<a href="#">Ext1/Ext2 selection</a>	<i>DI3</i>
<a href="#">19.14</a>	<a href="#">Ext2 control mode 1</a>	<i>Torque</i>
<a href="#">20.02</a>	<a href="#">Ext1 start trigger</a>	<i>Level</i>
<a href="#">20.06</a>	<a href="#">Ext2 commands</a>	<i>In1 Start; In2 Dir</i>
<a href="#">20.07</a>	<a href="#">Ext2 start trigger</a>	<i>Level</i>
<a href="#">20.08</a>	<a href="#">Ext2 in1</a>	<i>DI1</i>
<a href="#">20.09</a>	<a href="#">Ext2 in2</a>	<i>DI2</i>
<a href="#">20.12</a>	<a href="#">Run enable 1</a>	<i>DI6</i>
<a href="#">22.22</a>	<a href="#">Constant speed sel1</a>	<i>DI4</i>
<a href="#">23.11</a>	<a href="#">Ramp set selection</a>	<i>DI5</i>
<a href="#">26.11</a>	<a href="#">Torque ref1 selection</a>	<i>AI2 scaled</i>
<a href="#">31.11</a>	<a href="#">Fault reset selection</a>	<i>Off</i>

■ Default control connections for the Torque control macro

<b>XPOW</b> External power input		
1	+24VI	24 V DC, 2 A
2	GND	
<b>XAI</b> Reference voltage and analog inputs		
1	+VREF	10 V DC, $R_L$ 1...10 kohm
2	-VREF	-10 V DC, $R_L$ 1...10 kohm
3	AGND	Ground
4	AI1+	<b>Speed reference</b> 0(2)...10 V, $R_{in} > 200$ kohm
5	AI1-	
6	AI2+	<b>Torque reference</b> 0(4)...20 mA, $R_{in} > 100$ ohm
7	AI2-	
<b>XAO</b> Analog outputs		
1	AO1	<b>Motor speed rpm</b> 0...20 mA, $R_L < 500$ ohm
2	AGND	<b>Motor current</b> 0...20 mA, $R_L < 500$ ohm
3	AO2	
4	AGND	
<b>XD2D</b> Drive-to-drive link		
1	B	Drive-to-drive link
2	A	
3	BGND	
<b>XRO1, XRO2, XRO3</b> Relay outputs		
1	NC	 <b>Ready</b> 250 V AC / 30 V DC 2 A
2	COM	
3	NO	
1	NC	 <b>Running</b> 250 V AC / 30 V DC 2 A
2	COM	
3	NO	
1	NC	 <b>Faulted(-1)</b> 250 V AC / 30 V DC 2 A
2	COM	
3	NO	
<b>XD24</b> Digital interlock		
1	DIIL	Digital interlock. By default, not in use.
2	+24VD	+24 V DC 200 mA
3	DICOM	Digital input ground
4	+24VD	+24 V DC 200 mA
5	DIOGND	Digital input/output ground
<b>XDIO</b> Digital input/outputs		
1	DIO1	Output: Ready
2	DIO2	Output: Running
<b>XDI</b> Digital inputs		
1	DI1	Stop (0) / Start (1)
2	DI2	Forward (0) / Reverse (1)
3	DI3	Speed control (0) / Torque control (1)
4	DI4	Constant speed 1 (1 = On)
5	DI5	Acc/Dec time set 1 (0) / set 2 (1)
6	DI6	Run enable (1 = On)
<b>XSTO</b>	Safe torque off circuits must be closed for the drive to start. See <i>Hardware manual</i> of drive.	
<b>X12</b>	Safety options connection	
<b>X13</b>	Control panel connection	
<b>X205</b>	Memory unit connection	

## Sequential control macro

The Sequential control macro is suited for speed control applications in which a speed reference, multiple constant speeds, and two acceleration and deceleration ramps can be used.

The macro offers seven preset constant speeds which can be activated by digital inputs DI4...DI6 (see parameter [22.21 Constant speed function](#)). An external speed reference can be given through analog input AI1. The reference is active only when no constant speed is activated (digital inputs DI4...DI6 are all off). Operational commands can also be given from the control panel.

The start/stop commands are given through digital input DI1; running direction is determined by DI2.

Two acceleration/deceleration ramps are selectable through DI3. The acceleration and deceleration times, as well as ramp shapes, are defined by parameters [23.12...23.19](#).

### ■ Operation diagram

The figure below shows an example of the use of the macro.

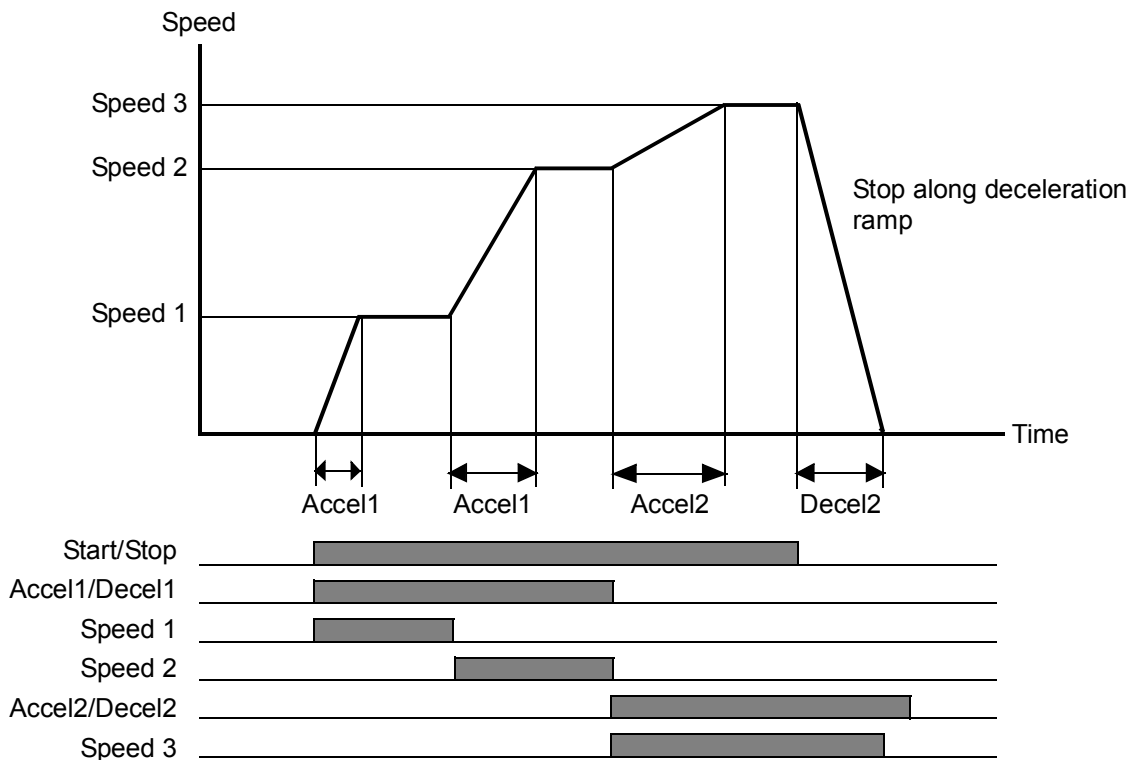

## ■ Selection of constant speeds

By default, constant speeds 1...7 are selected using digital inputs DI4...DI6 as follows:



DI4	DI5	DI6	Constant speed active
0	0	0	None (External speed reference used)
1	0	0	Constant speed 1
0	1	0	Constant speed 2
1	1	0	Constant speed 3
0	0	1	Constant speed 4
1	0	1	Constant speed 5
0	1	1	Constant speed 6
1	1	1	Constant speed 7

## ■ Default parameter settings for the Sequential control macro

Below is a listing of default parameter values that differ from those listed for the Factory macro in [Parameter listing](#) (page 84).

Parameter		Sequential control macro default
No.	Name	
21.03	<i>Stop mode</i>	<i>Ramp</i>
22.21	<i>Constant speed function</i>	01b (Bit 0 = Packed)
22.22	<i>Constant speed sel1</i>	<i>DI4</i>
22.23	<i>Constant speed sel2</i>	<i>DI5</i>
22.24	<i>Constant speed sel3</i>	<i>DI6</i>
22.27	<i>Constant speed 2</i>	600.00 rpm
22.28	<i>Constant speed 3</i>	900.00 rpm
22.29	<i>Constant speed 4</i>	1200.00 rpm
22.30	<i>Constant speed 5</i>	1500.00 rpm
22.31	<i>Constant speed 6</i>	2400.00 rpm
22.32	<i>Constant speed 7</i>	3000.00 rpm
23.11	<i>Ramp set selection</i>	<i>DI3</i>
25.06	<i>Acc comp derivation time</i>	0.12 s
31.11	<i>Fault reset selection</i>	<i>Off</i>

## Default control connections for the Sequential control macro

<b>XPOW</b> External power input		
1	+24VI	24 V DC, 2 A
2	GND	
<b>XAI</b> Reference voltage and analog inputs		
1	+VREF	10 V DC, $R_L$ 1...10 kohm
2	-VREF	-10 V DC, $R_L$ 1...10 kohm
3	AGND	Ground
4	AI1+	<b>External speed reference</b>
5	AI1-	0(2)...10 V, $R_{in} > 200$ kohm
6	AI2+	By default, not in use.
7	AI2-	0(4)...20 mA, $R_{in} > 100$ ohm
<b>XAO</b> Analog outputs		
1	AO1	<b>Motor speed rpm</b>
2	AGND	0...20 mA, $R_L < 500$ ohm
3	AO2	<b>Motor current</b>
4	AGND	0...20 mA, $R_L < 500$ ohm
<b>XD2D</b> Drive-to-drive link		
1	B	Drive-to-drive link
2	A	
3	BGND	
<b>XRO1, XRO2, XRO3</b> Relay outputs		
1	NC	 <b>Ready</b> 250 V AC / 30 V DC 2 A
2	COM	
3	NO	
1	NC	 <b>Running</b> 250 V AC / 30 V DC 2 A
2	COM	
3	NO	
1	NC	 <b>Faulted(-1)</b> 250 V AC / 30 V DC 2 A
2	COM	
3	NO	
<b>XD24</b> Digital interlock		
1	DIIL	Digital interlock. By default, not in use.
2	+24VD	+24 V DC 200 mA
3	DICOM	Digital input ground
4	+24VD	+24 V DC 200 mA
5	DIOGND	Digital input/output ground
<b>XDIO</b> Digital input/outputs		
1	DIO1	Output: Ready
2	DIO2	Output: Running
<b>XDI</b> Digital inputs		
1	DI1	Stop (0) / Start (1)
2	DI2	Forward (0) / Reverse (1)
3	DI3	Acc/Dec time set 1 (0) / set 2 (1)
4	DI4	Constant speed selection (see page 77)
5	DI5	
6	DI6	
<b>XSTO</b>	Safe torque off circuits must be closed for the drive to start. See <i>Hardware manual</i> of drive.	
<b>X12</b>	Safety options connection	
<b>X13</b>	Control panel connection	
<b>X205</b>	Memory unit connection	

## **Fieldbus control macro**

This application macro is not supported by the current firmware version.





## 6

# Parameters

---

## What this chapter contains

The chapter describes the parameters, including actual signals, of the control program.

## Terms and abbreviations

Term	Definition
Actual signal	Type of <i>parameter</i> that is the result of a measurement or calculation by the drive, or contains status information. Most actual signals are read-only, but some (especially counter-type actual signals) can be reset.
Def	(In the following table, shown on the same row as the parameter name) The default value of a <i>parameter</i> for the Factory macro. For information on macro-specific parameter values, see chapter <i>Application macros</i> (page 65).
FbEq16	(In the following table, shown on the same row as the parameter range, or for each selection) 16-bit fieldbus equivalent: The scaling between the value shown on the panel and the integer used in fieldbus communication when a 16-bit value is selected in parameter group <i>52 FBA A data in</i> or <i>53 FBA A data out</i> . A dash (-) indicates that the parameter is not accessible in 16-bit format. The corresponding 32-bit scalings are listed in chapter <i>Additional parameter data</i> (page 271).
Other [bit]	The value is taken from a specific bit in another parameter. The source is selected from a parameter list.
Parameter	Either a user-adjustable operating instruction for the drive, or an <i>actual signal</i> .
p.u.	Per unit

---

## Summary of parameter groups

<a href="#">01 Actual values</a>	Basic signals for monitoring of the drive.	<a href="#">84</a>
<a href="#">03 Input references</a>	Values of references received from various sources.	<a href="#">85</a>
<a href="#">04 Warnings and faults</a>	Information on warnings and faults that occurred last.	<a href="#">86</a>
<a href="#">05 Diagnostics</a>	Various run-time-type counters and measurements related to drive maintenance.	<a href="#">87</a>
<a href="#">06 Control and status words</a>	Drive control and status words.	<a href="#">88</a>
<a href="#">07 System info</a>	Drive hardware and firmware information.	<a href="#">91</a>
<a href="#">10 Standard DI, RO</a>	Configuration of digital inputs and relay outputs.	<a href="#">91</a>
<a href="#">11 Standard DIO, FI, FO</a>	Configuration of digital input/outputs and frequency inputs/outputs.	<a href="#">96</a>
<a href="#">12 Standard AI</a>	Configuration of analog inputs.	<a href="#">102</a>
<a href="#">13 Standard AO</a>	Configuration of analog outputs.	<a href="#">104</a>
<a href="#">14 I/O extension module 1</a>	Configuration of I/O extension module 1.	<a href="#">108</a>
<a href="#">15 I/O extension module 2</a>	Configuration of I/O extension module 2.	<a href="#">124</a>
<a href="#">16 I/O extension module 3</a>	Configuration of I/O extension module 3.	<a href="#">127</a>
<a href="#">19 Operation mode</a>	Selection of external control location sources and operating modes.	<a href="#">130</a>
<a href="#">20 Start/stop/direction</a>	Start/stop/direction and run/start/jog enable signal source selection; positive/negative reference enable signal source selection.	<a href="#">132</a>
<a href="#">21 Start/stop mode</a>	Start and stop modes; emergency stop mode and signal source selection; DC magnetization settings; autophasing mode selection.	<a href="#">140</a>
<a href="#">22 Speed reference selection</a>	Speed reference selection.	<a href="#">145</a>
<a href="#">23 Speed reference ramp</a>	Speed reference ramp settings.	<a href="#">151</a>
<a href="#">24 Speed reference conditioning</a>	Speed error calculation; speed error window control configuration; speed error step.	<a href="#">155</a>
<a href="#">25 Speed control</a>	Speed controller settings.	<a href="#">158</a>
<a href="#">26 Torque reference chain</a>	Settings of the torque reference chain.	<a href="#">164</a>
<a href="#">28 Frequency reference chain</a>	Settings of the frequency reference chain.	<a href="#">168</a>
<a href="#">30 Limits</a>	Drive operation limits.	<a href="#">175</a>
<a href="#">31 Fault functions</a>	Settings that define the behavior of the drive upon fault situations.	<a href="#">177</a>
<a href="#">32 Supervision</a>	Configuration of signal supervision functions 1...3.	<a href="#">183</a>
<a href="#">33 Maintenance timer &amp; counter</a>	Configuration of maintenance timers/counters.	<a href="#">187</a>
<a href="#">35 Motor thermal protection</a>	Motor thermal protection settings.	<a href="#">193</a>
<a href="#">36 Load analyzer</a>	Peak value and amplitude logger settings.	<a href="#">200</a>
<a href="#">40 Process PID set 1</a>	Parameter values for process PID control.	<a href="#">203</a>
<a href="#">41 Process PID set 2</a>	A second set of parameter values for process PID control.	<a href="#">214</a>
<a href="#">43 Brake chopper</a>	Settings of the internal brake chopper.	<a href="#">215</a>
<a href="#">44 Mechanical brake control</a>	Configuration of mechanical brake control.	<a href="#">217</a>
<a href="#">45 Energy efficiency</a>	Settings of the energy savings calculator.	<a href="#">221</a>
<a href="#">46 Monitoring/scaling settings</a>	Speed supervision settings; actual signal filtering; general scaling settings.	<a href="#">223</a>

<a href="#">47 Data storage</a>	Data storage parameters that can be written to and read from using other parameters' source and target settings.	<a href="#">225</a>
<a href="#">49 Panel port communication</a>	Communication settings for the control panel port on the drive.	<a href="#">227</a>
<a href="#">50 Fieldbus adapter (FBA)</a>	Fieldbus communication configuration.	<a href="#">227</a>
<a href="#">51 FBA A settings</a>	Fieldbus adapter A configuration.	<a href="#">231</a>
<a href="#">52 FBA A data in</a>	Selection of data to be transferred from drive to fieldbus controller through fieldbus adapter A.	<a href="#">232</a>
<a href="#">53 FBA A data out</a>	Selection of data to be transferred from fieldbus controller to drive through fieldbus adapter A.	<a href="#">233</a>
<a href="#">60 D2D and DDCCS communication</a>	DDCCS (fiber optic) communication configuration.	<a href="#">233</a>
<a href="#">61 D2D and DDCCS transmit data</a>	Defines the data sent to the DDCCS link.	<a href="#">237</a>
<a href="#">62 D2D and DDCCS receive data</a>	Mapping of data received through the DDCCS link.	<a href="#">239</a>
<a href="#">90 Feedback selection</a>	Motor speed feedback configuration.	<a href="#">243</a>
<a href="#">91 Encoder module settings</a>	Configuration of encoder interface modules.	<a href="#">248</a>
<a href="#">92 Encoder 1 configuration</a>	Settings for encoder 1.	<a href="#">250</a>
<a href="#">93 Encoder 2 configuration</a>	Settings for encoder 2.	<a href="#">255</a>
<a href="#">95 HW configuration</a>	Various hardware-related settings.	<a href="#">257</a>
<a href="#">96 System</a>	Language selection; parameter save and restore; user parameter sets; control unit reboot.	<a href="#">259</a>
<a href="#">97 Motor control</a>	Switching frequency; slip gain; voltage reserve; flux braking; signal injection; IR compensation.	<a href="#">262</a>
<a href="#">98 User motor parameters</a>	Motor values supplied by the user that are used in the motor model.	<a href="#">264</a>
<a href="#">99 Motor data</a>	Motor configuration settings.	<a href="#">265</a>

## Parameter listing

No.	Name/Value	Description	Def/FbEq16
<b>01 Actual values</b>		Basic signals for monitoring of the drive. All parameters in this group are read-only unless otherwise noted.	
01.01	<i>Motor speed used</i>	Measured or estimated motor speed depending on which type of feedback is used (see parameter <a href="#">90.41 Motor feedback selection</a> ). A filter time constant for this signal can be defined by parameter <a href="#">46.11 Filter time motor speed</a> .	-
	-30000.00 ... 30000.00 rpm	Measured or estimated motor speed.	See par. <a href="#">46.01</a>
01.02	<i>Motor speed estimated</i>	Estimated motor speed in rpm. A filter time constant for this signal can be defined by parameter <a href="#">46.11 Filter time motor speed</a> .	-
	-30000.00 ... 30000.00 rpm	Estimated motor speed.	See par. <a href="#">46.01</a>
01.04	<i>Encoder 1 speed filtered</i>	Speed of encoder 1 in rpm. A filter time constant for this signal can be defined by parameter <a href="#">46.11 Filter time motor speed</a> .	-
	-30000.00 ... 30000.00 rpm	Encoder 1 speed.	See par. <a href="#">46.01</a>
01.05	<i>Encoder 2 speed filtered</i>	Speed of encoder 2 in rpm. A filter time constant for this signal can be defined by parameter <a href="#">46.11 Filter time motor speed</a> .	-
	-30000.00 ... 30000.00 rpm	Encoder 2 speed.	See par. <a href="#">46.01</a>
01.06	<i>Output frequency</i>	Estimated drive output frequency in Hz. A filter time constant for this signal can be defined by parameter <a href="#">46.12 Filter time output frequency</a> .	-
	-500.00 ... 500.00 Hz	Estimated output frequency.	See par. <a href="#">46.02</a>
01.07	<i>Motor current</i>	Measured (absolute) motor current in A.	-
	0.00 ... 30000.00 A	Motor current.	1 = 1 A
01.10	<i>Motor torque %</i>	Motor torque in percent of the nominal motor torque. See also parameter <a href="#">01.30 Nominal torque scale</a> . A filter time constant for this signal can be defined by parameter <a href="#">46.13 Filter time motor torque</a> .	-
	-1600.0 ... 1600.0%	Motor torque.	See par. <a href="#">46.03</a>
01.11	<i>DC voltage</i>	Measured intermediate circuit voltage.	-
	0.00 ... 2000.00 V	Intermediate circuit voltage.	10 = 1 V
01.13	<i>Output voltage</i>	Calculated motor voltage in V AC.	-
	0.00 ... 2000.00 V	Motor voltage.	10 = 1 V
01.14	<i>Output power</i>	Drive output power in kW. A filter time constant for this signal can be defined by parameter <a href="#">46.14 Filter time power out</a> .	-
	-32768.00 ... 32767.00 kW	Output power.	1 = 1 kW
01.18	<i>Inverter GWh counter</i>	Amount of energy that has passed through the drive (in either direction) in full gigawatt-hours. The minimum value is zero.	-
	0...65535 GWh	Energy in GWh.	1 = 1 GWh

No.	Name/Value	Description	Def/FbEq16
<a href="#">01.19</a>	<a href="#">Inverter MWh counter</a>	Amount of energy that has passed through the drive (in either direction) in full megawatt-hours. Whenever the counter rolls over, <a href="#">01.18 Inverter GWh counter</a> is incremented. The minimum value is zero.	-
	0...999 MWh	Energy in MWh.	1 = 1 MWh
<a href="#">01.20</a>	<a href="#">Inverter kWh counter</a>	Amount of energy that has passed through the drive (in either direction) in full kilowatt-hours. Whenever the counter rolls over, <a href="#">01.19 Inverter MWh counter</a> is incremented. The minimum value is zero.	-
	0...999 kWh	Energy in kWh.	10 = 1 kWh
<a href="#">01.24</a>	<a href="#">Flux actual %</a>	Used flux reference in percent of nominal flux of motor.	-
	0...200%	Flux reference.	1 = 1%
<a href="#">01.30</a>	<a href="#">Nominal torque scale</a>	Torque that corresponds to 100% of nominal motor torque. <b>Note:</b> This value is copied from parameter <a href="#">99.12 Motor nominal torque</a> if entered. Otherwise the value is calculated from other motor data.	-
	0... N•m	Nominal torque.	1 = 100 N•m
<a href="#">01.31</a>	<a href="#">Ambient temperature</a>	Measured temperature of incoming cooling air in °C.	-
	-32768.0 ... 32767.0 °C	Cooling air temperature.	1 = 1 °C
<b>03 Input references</b>		Values of references received from various sources. All parameters in this group are read-only unless otherwise noted.	
<a href="#">03.01</a>	<a href="#">Panel reference</a>	Reference given from the control panel or PC tool.	-
	-100000.00 ... 100000.00	Control panel or PC tool reference.	1 = 10
<a href="#">03.03</a>	<a href="#">Ethernet PC tool reference 1</a>	Reference given from the PC tool through Ethernet.	
	-30000.00 ... 30000.00	PC tool reference through Ethernet.	1 = 10
<a href="#">03.05</a>	<a href="#">FB A reference 1</a>	Reference 1 received through fieldbus adapter A. See also chapter <a href="#">Fieldbus control through a fieldbus adapter</a> (page 333).	-
	-100000.00 ... 100000.00	Reference 1 from fieldbus adapter A.	1 = 10
<a href="#">03.06</a>	<a href="#">FB A reference 2</a>	Reference 2 received through fieldbus adapter A.	-
	-100000.00 ... 100000.00	Reference 2 from fieldbus adapter A.	1 = 10
<a href="#">03.11</a>	<a href="#">DDCS controller ref 1</a>	Reference 1 received from the external (DDCS) controller. The value has been scaled according to parameter <a href="#">60.60 DDCS controller ref1 type</a> . See also section <a href="#">External controller interface</a> (page 32).	1 = 10
	-30000.00 ... 30000.00	Scaled reference 1 received from external controller.	1 = 10

No.	Name/Value	Description	Def/FbEq16
03.12	<i>DDCS controller ref 2</i>	Reference 2 received from the external (DDCS) controller. The value has been scaled according to parameter <a href="#">60.61 DDCS controller ref2 type</a> .	1 = 10
	-30000.00 ... 30000.00	Scaled reference 2 received from external controller.	1 = 10
03.13	<i>M/F or D2D ref1</i>	Master/follower reference 1 received from the master. The value has been scaled according to parameter <a href="#">60.10 M/F ref1 type</a> . See also section <a href="#">Master/follower functionality</a> (page 27).	1 = 10
	-30000.00 ... 30000.00	Scaled reference 1 received from master.	1 = 10
03.14	<i>M/F or D2D ref2</i>	Master/follower reference 2 received from the master. The value has been scaled according to parameter <a href="#">60.11 M/F ref2 type</a> .	1 = 10
	-30000.00 ... 30000.00	Scaled reference 2 received from master.	1 = 10

<b>04 Warnings and faults</b>		Information on warnings and faults that occurred last. For explanations of individual warning and fault codes, see chapter <a href="#">Fault tracing</a> . All parameters in this group are read-only unless otherwise noted.	
04.01	<i>Tripping fault</i>	Code of the 1st active fault (the fault that caused the current trip).	-
	0000h...FFFFh	1st active fault.	1 = 1
04.02	<i>Active fault 2</i>	Code of the 2nd active fault.	-
	0000h...FFFFh	2nd active fault.	1 = 1
04.03	<i>Active fault 3</i>	Code of the 3rd active fault.	-
	0000h...FFFFh	3rd active fault.	1 = 1
04.04	<i>Active fault 4</i>	Code of the 4th active fault.	-
	0000h...FFFFh	4th active fault.	1 = 1
04.05	<i>Active fault 5</i>	Code of the 5th active fault.	-
	0000h...FFFFh	5th active fault.	1 = 1
04.06	<i>Active warning 1</i>	Code of the 1st active warning.	-
	0000h...FFFFh	1st active warning.	1 = 1
04.07	<i>Active warning 2</i>	Code of the 2nd active warning.	-
	0000h...FFFFh	2nd active warning.	1 = 1
04.08	<i>Active warning 3</i>	Code of the 3rd active warning.	-
	0000h...FFFFh	3rd active warning.	1 = 1
04.09	<i>Active warning 4</i>	Code of the 4th active warning.	-
	0000h...FFFFh	4th active warning.	1 = 1
04.10	<i>Active warning 5</i>	Code of the 5th active warning.	-
	0000h...FFFFh	5th active warning.	1 = 1
04.11	<i>Latest fault</i>	Code of the 1st stored (non-active) fault.	-
	0000h...FFFFh	1st stored fault.	1 = 1

No.	Name/Value	Description	Def/FbEq16
<i>04.12</i>	<i>2nd latest fault</i>	Code of the 2nd stored (non-active) fault.	-
	0000h...FFFFh	2nd stored fault.	1 = 1
<i>04.13</i>	<i>3rd latest fault</i>	Code of the 3rd stored (non-active) fault.	-
	0000h...FFFFh	3rd stored fault.	1 = 1
<i>04.14</i>	<i>4th latest fault</i>	Code of the 4th stored (non-active) fault.	-
	0000h...FFFFh	4th stored fault.	1 = 1
<i>04.15</i>	<i>5th latest fault</i>	Code of the 5th stored (non-active) fault.	-
	0000h...FFFFh	5th stored fault.	1 = 1
<i>04.16</i>	<i>Latest warning</i>	Code of the 1st stored (non-active) warning.	-
	0000h...FFFFh	1st stored warning.	1 = 1
<i>04.17</i>	<i>2nd latest warning</i>	Code of the 2nd stored (non-active) warning.	-
	0000h...FFFFh	2nd stored warning.	1 = 1
<i>04.18</i>	<i>3rd latest warning</i>	Code of the 3rd stored (non-active) warning.	-
	0000h...FFFFh	3rd stored warning.	1 = 1
<i>04.19</i>	<i>4th latest warning</i>	Code of the 4th stored (non-active) warning.	-
	0000h...FFFFh	4th stored warning.	1 = 1
<i>04.20</i>	<i>5th latest warning</i>	Code of the 5th stored (non-active) warning.	-
	0000h...FFFFh	5th stored warning.	1 = 1
<b>05 Diagnostics</b>		Various run-time-type counters and measurements related to drive maintenance. All parameters in this group are read-only unless otherwise noted.	
<i>05.01</i>	<i>On-time counter</i>	On-time counter. The counter runs when the drive is powered.	-
	0...4294967295 d	On-time counter.	1 = 1 d
<i>05.02</i>	<i>Run-time counter</i>	Motor run-time counter. The counter runs when the inverter modulates.	-
	0...4294967295 d	Motor run-time counter.	1 = 1 d
<i>05.04</i>	<i>Fan on-time counter</i>	Running time of the drive cooling fan. Can be reset on the control panel by keeping Reset depressed for over 3 seconds.	-
	0...4294967295 d	Cooling fan run-time counter.	1 = 1 d
<i>05.11</i>	<i>Inverter temperature %</i>	Estimated drive temperature in percent of fault limit.	-
	-40.0 ... 160.0%	Drive temperature in percent.	1 = 1%

No.	Name/Value	Description	Def/FbEq16																																										
<b>06 Control and status words</b>		Drive control and status words.																																											
<b>06.01</b>	<b>Main control word</b>	The main control word of the drive. This parameter shows the control signals as received from the selected sources (such as digital inputs, the fieldbus interface and the application program). The bit assignments of the word are as described on page 339. The related status word and state diagram are presented on pages 340 and 341 respectively. This parameter is read-only.	-																																										
	0000h...FFFFh	Main control word.	1 = 1																																										
<b>06.02</b>	<b>Application control word</b>	The drive control word received from the application program (if any). The bit assignments are described on page 339. This parameter is read-only.	-																																										
	0000h...FFFFh	Application program control word.	1 = 1																																										
<b>06.03</b>	<b>FBA A transparent control word</b>	The unaltered control word received from the PLC through fieldbus adapter A. This parameter is read-only.	-																																										
	00000000h ... FFFFFFFFh	Control word received through fieldbus adapter A.	-																																										
<b>06.11</b>	<b>Main status word</b>	Main status word of the drive. The bit assignments are described on page 340. The related control word and state diagram are presented on pages 339 and 341 respectively. This parameter is read-only.	-																																										
	0000h...FFFFh	Main status word.	1 = 1																																										
<b>06.16</b>	<b>Drive status word 1</b>	Drive status word 1. This parameter is read-only.	-																																										
		<table border="1"> <thead> <tr> <th>Bit</th> <th>Name</th> <th>Description</th> </tr> </thead> <tbody> <tr> <td>0</td> <td>Enabled</td> <td>1 = Both run enable (see par. 20.12) and start enable (20.19) signals are present. <b>Note:</b> This bit is not affected by the presence of a fault.</td> </tr> <tr> <td>1</td> <td>Inhibited</td> <td>1 = Start inhibited. To start the drive, the inhibiting signal (see par. 06.18) must be removed and the start signal cycled.</td> </tr> <tr> <td>2</td> <td>Operation allowed</td> <td>1 = Drive is ready to operate</td> </tr> <tr> <td>3</td> <td>Ready to start</td> <td>1 = Drive is ready to receive a start command</td> </tr> <tr> <td>4</td> <td>Running</td> <td>1 = Drive is ready to follow given reference</td> </tr> <tr> <td>5</td> <td>Started</td> <td>1 = Drive has been started</td> </tr> <tr> <td>6</td> <td>Modulating</td> <td>1 = Drive is modulating (output stage is being controlled)</td> </tr> <tr> <td>7</td> <td>Limiting</td> <td>1 = Any operating limit (speed, torque, etc.) is active</td> </tr> <tr> <td>8</td> <td>Local control</td> <td>1 = Drive is in local control</td> </tr> <tr> <td>9</td> <td>Network ctrl</td> <td>1 = Drive is in <i>network control</i></td> </tr> <tr> <td>10</td> <td>Ext1 active</td> <td>1 = Control location EXT1 active</td> </tr> <tr> <td>11</td> <td>Ext2 active</td> <td>1 = Control location EXT2 active</td> </tr> <tr> <td>12...15</td> <td>Reserved</td> <td></td> </tr> </tbody> </table>	Bit	Name	Description	0	Enabled	1 = Both run enable (see par. 20.12) and start enable (20.19) signals are present. <b>Note:</b> This bit is not affected by the presence of a fault.	1	Inhibited	1 = Start inhibited. To start the drive, the inhibiting signal (see par. 06.18) must be removed and the start signal cycled.	2	Operation allowed	1 = Drive is ready to operate	3	Ready to start	1 = Drive is ready to receive a start command	4	Running	1 = Drive is ready to follow given reference	5	Started	1 = Drive has been started	6	Modulating	1 = Drive is modulating (output stage is being controlled)	7	Limiting	1 = Any operating limit (speed, torque, etc.) is active	8	Local control	1 = Drive is in local control	9	Network ctrl	1 = Drive is in <i>network control</i>	10	Ext1 active	1 = Control location EXT1 active	11	Ext2 active	1 = Control location EXT2 active	12...15	Reserved		
Bit	Name	Description																																											
0	Enabled	1 = Both run enable (see par. 20.12) and start enable (20.19) signals are present. <b>Note:</b> This bit is not affected by the presence of a fault.																																											
1	Inhibited	1 = Start inhibited. To start the drive, the inhibiting signal (see par. 06.18) must be removed and the start signal cycled.																																											
2	Operation allowed	1 = Drive is ready to operate																																											
3	Ready to start	1 = Drive is ready to receive a start command																																											
4	Running	1 = Drive is ready to follow given reference																																											
5	Started	1 = Drive has been started																																											
6	Modulating	1 = Drive is modulating (output stage is being controlled)																																											
7	Limiting	1 = Any operating limit (speed, torque, etc.) is active																																											
8	Local control	1 = Drive is in local control																																											
9	Network ctrl	1 = Drive is in <i>network control</i>																																											
10	Ext1 active	1 = Control location EXT1 active																																											
11	Ext2 active	1 = Control location EXT2 active																																											
12...15	Reserved																																												
	0000h...FFFFh	Status word 1.	1 = 1																																										



No.	Name/Value	Description	Def/FbEq16																																																			
06.17	<i>Drive status word 2</i>	Drive status word 2. This parameter is read-only.	-																																																			
		<table border="1"> <thead> <tr> <th>Bit</th> <th>Name</th> <th>Description</th> </tr> </thead> <tbody> <tr> <td>0</td> <td>Identification run done</td> <td>1 = Motor identification (ID) run has been performed</td> </tr> <tr> <td>1</td> <td>Magnetized</td> <td>1 = The motor has been magnetized</td> </tr> <tr> <td>2</td> <td>Torque control</td> <td>1 = Torque control mode active</td> </tr> <tr> <td>3</td> <td>Speed control</td> <td>1 = Speed control mode active</td> </tr> <tr> <td>4</td> <td>Power control</td> <td>1 = Power control mode active</td> </tr> <tr> <td>5</td> <td>Safe reference active</td> <td>1 = A "safe" reference is applied by functions such as parameters <a href="#">49.05</a> and <a href="#">50.02</a></td> </tr> <tr> <td>6</td> <td>Last speed active</td> <td>1 = A "last speed" reference is applied by functions such as parameters <a href="#">49.05</a> and <a href="#">50.02</a></td> </tr> <tr> <td>7</td> <td>Loss of reference</td> <td>1 = Reference signal lost</td> </tr> <tr> <td>8</td> <td>Emergency stop failed</td> <td>1 = Emergency stop failed</td> </tr> <tr> <td>9...15</td> <td>Reserved</td> <td></td> </tr> </tbody> </table>	Bit	Name	Description	0	Identification run done	1 = Motor identification (ID) run has been performed	1	Magnetized	1 = The motor has been magnetized	2	Torque control	1 = Torque control mode active	3	Speed control	1 = Speed control mode active	4	Power control	1 = Power control mode active	5	Safe reference active	1 = A "safe" reference is applied by functions such as parameters <a href="#">49.05</a> and <a href="#">50.02</a>	6	Last speed active	1 = A "last speed" reference is applied by functions such as parameters <a href="#">49.05</a> and <a href="#">50.02</a>	7	Loss of reference	1 = Reference signal lost	8	Emergency stop failed	1 = Emergency stop failed	9...15	Reserved																				
Bit	Name	Description																																																				
0	Identification run done	1 = Motor identification (ID) run has been performed																																																				
1	Magnetized	1 = The motor has been magnetized																																																				
2	Torque control	1 = Torque control mode active																																																				
3	Speed control	1 = Speed control mode active																																																				
4	Power control	1 = Power control mode active																																																				
5	Safe reference active	1 = A "safe" reference is applied by functions such as parameters <a href="#">49.05</a> and <a href="#">50.02</a>																																																				
6	Last speed active	1 = A "last speed" reference is applied by functions such as parameters <a href="#">49.05</a> and <a href="#">50.02</a>																																																				
7	Loss of reference	1 = Reference signal lost																																																				
8	Emergency stop failed	1 = Emergency stop failed																																																				
9...15	Reserved																																																					
	0000h...FFFFh	Control status word 1.	1 = 1																																																			
06.18	<i>Start inhibit status word</i>	Start inhibit status word. This word specifies the source of the inhibiting signal that is preventing the drive from starting. The conditions marked with an asterisk (*) only require that the start command is cycled. In all other instances, the inhibiting condition must be removed first. See also parameter <a href="#">06.16 Drive status word 1</a> , bit 1. This parameter is read-only.	-																																																			
		<table border="1"> <thead> <tr> <th>Bit</th> <th>Name</th> <th>Description</th> </tr> </thead> <tbody> <tr> <td>0</td> <td>Not ready run</td> <td>1 = DC voltage is missing or drive has not been parametrized correctly. Check the parameters in groups 95 and 99.</td> </tr> <tr> <td>1</td> <td>Ctrl location changed</td> <td>* 1 = Control location has changed</td> </tr> <tr> <td>2</td> <td>SSW inhibit</td> <td>1 = Control program is keeping itself in inhibited state</td> </tr> <tr> <td>3</td> <td>Fault reset</td> <td>* 1 = A fault has been reset</td> </tr> <tr> <td>4</td> <td>Lost start enable</td> <td>1 = Start enable signal missing</td> </tr> <tr> <td>5</td> <td>Lost run enable</td> <td>1 = Run enable signal missing</td> </tr> <tr> <td>6</td> <td>FSO inhibit</td> <td>1 = Operation prevented by FSO-xx safety functions module</td> </tr> <tr> <td>7</td> <td>STO</td> <td>1 = Safe torque off active</td> </tr> <tr> <td>8</td> <td>Current calibration ended</td> <td>* 1 = Current calibration routine has finished</td> </tr> <tr> <td>9</td> <td>ID run ended</td> <td>* 1 = Motor identification run has finished</td> </tr> <tr> <td>10</td> <td>Auto phase ended</td> <td>* 1 = Autophasing routine has finished</td> </tr> <tr> <td>11</td> <td>Em Off1</td> <td>1 = Emergency stop signal (mode off1)</td> </tr> <tr> <td>12</td> <td>Em Off2</td> <td>1 = Emergency stop signal (mode off2)</td> </tr> <tr> <td>13</td> <td>Em Off3</td> <td>1 = Emergency stop signal (mode off3)</td> </tr> <tr> <td>14</td> <td>Auto reset inhibit</td> <td>1 = The autoreset function is inhibiting operation</td> </tr> <tr> <td>15</td> <td>Reserved</td> <td></td> </tr> </tbody> </table>	Bit	Name	Description	0	Not ready run	1 = DC voltage is missing or drive has not been parametrized correctly. Check the parameters in groups 95 and 99.	1	Ctrl location changed	* 1 = Control location has changed	2	SSW inhibit	1 = Control program is keeping itself in inhibited state	3	Fault reset	* 1 = A fault has been reset	4	Lost start enable	1 = Start enable signal missing	5	Lost run enable	1 = Run enable signal missing	6	FSO inhibit	1 = Operation prevented by FSO-xx safety functions module	7	STO	1 = Safe torque off active	8	Current calibration ended	* 1 = Current calibration routine has finished	9	ID run ended	* 1 = Motor identification run has finished	10	Auto phase ended	* 1 = Autophasing routine has finished	11	Em Off1	1 = Emergency stop signal (mode off1)	12	Em Off2	1 = Emergency stop signal (mode off2)	13	Em Off3	1 = Emergency stop signal (mode off3)	14	Auto reset inhibit	1 = The autoreset function is inhibiting operation	15	Reserved		
Bit	Name	Description																																																				
0	Not ready run	1 = DC voltage is missing or drive has not been parametrized correctly. Check the parameters in groups 95 and 99.																																																				
1	Ctrl location changed	* 1 = Control location has changed																																																				
2	SSW inhibit	1 = Control program is keeping itself in inhibited state																																																				
3	Fault reset	* 1 = A fault has been reset																																																				
4	Lost start enable	1 = Start enable signal missing																																																				
5	Lost run enable	1 = Run enable signal missing																																																				
6	FSO inhibit	1 = Operation prevented by FSO-xx safety functions module																																																				
7	STO	1 = Safe torque off active																																																				
8	Current calibration ended	* 1 = Current calibration routine has finished																																																				
9	ID run ended	* 1 = Motor identification run has finished																																																				
10	Auto phase ended	* 1 = Autophasing routine has finished																																																				
11	Em Off1	1 = Emergency stop signal (mode off1)																																																				
12	Em Off2	1 = Emergency stop signal (mode off2)																																																				
13	Em Off3	1 = Emergency stop signal (mode off3)																																																				
14	Auto reset inhibit	1 = The autoreset function is inhibiting operation																																																				
15	Reserved																																																					
	0000h...FFFFh	Start inhibit status word.	1 = 1																																																			

## 90 Parameters

No.	Name/Value	Description	Def/FbEq16																														
<a href="#">06.19</a>	<a href="#">Speed control status word</a>	Speed control status word. This parameter is read-only.	-																														
		<table border="1"> <thead> <tr> <th>Bit</th> <th>Name</th> <th>Description</th> </tr> </thead> <tbody> <tr> <td>0</td> <td>Zero speed</td> <td>1 = Drive is running at zero speed</td> </tr> <tr> <td>1</td> <td>Forward</td> <td>1 = Drive is running in forward direction above zero speed limit (par. <a href="#">21.06</a>)</td> </tr> <tr> <td>2</td> <td>Reverse</td> <td>1 = Drive is running in reverse direction above zero speed limit (par. <a href="#">21.06</a>)</td> </tr> <tr> <td>3</td> <td>Out of window</td> <td>1 = Motor speed outside speed window (see par. group <a href="#">24 Speed reference conditioning</a>)</td> </tr> <tr> <td>4</td> <td>Internal speed feedback</td> <td>1 = Estimated speed feedback used (see par. <a href="#">90.41</a>)</td> </tr> <tr> <td>5</td> <td>Encoder 1 feedback</td> <td>1 = Encoder 1 used for speed feedback (see par. <a href="#">90.41</a>)</td> </tr> <tr> <td>6</td> <td>Encoder 2 feedback</td> <td>1 = Encoder 2 used for speed feedback (see par. <a href="#">90.41</a>)</td> </tr> <tr> <td>7</td> <td>Any constant speed request</td> <td>1 = A constant speed has been selected; see par. <a href="#">06.20</a>.</td> </tr> <tr> <td>8...15</td> <td>Reserved</td> <td></td> </tr> </tbody> </table>	Bit	Name	Description	0	Zero speed	1 = Drive is running at zero speed	1	Forward	1 = Drive is running in forward direction above zero speed limit (par. <a href="#">21.06</a> )	2	Reverse	1 = Drive is running in reverse direction above zero speed limit (par. <a href="#">21.06</a> )	3	Out of window	1 = Motor speed outside speed window (see par. group <a href="#">24 Speed reference conditioning</a> )	4	Internal speed feedback	1 = Estimated speed feedback used (see par. <a href="#">90.41</a> )	5	Encoder 1 feedback	1 = Encoder 1 used for speed feedback (see par. <a href="#">90.41</a> )	6	Encoder 2 feedback	1 = Encoder 2 used for speed feedback (see par. <a href="#">90.41</a> )	7	Any constant speed request	1 = A constant speed has been selected; see par. <a href="#">06.20</a> .	8...15	Reserved		
Bit	Name	Description																															
0	Zero speed	1 = Drive is running at zero speed																															
1	Forward	1 = Drive is running in forward direction above zero speed limit (par. <a href="#">21.06</a> )																															
2	Reverse	1 = Drive is running in reverse direction above zero speed limit (par. <a href="#">21.06</a> )																															
3	Out of window	1 = Motor speed outside speed window (see par. group <a href="#">24 Speed reference conditioning</a> )																															
4	Internal speed feedback	1 = Estimated speed feedback used (see par. <a href="#">90.41</a> )																															
5	Encoder 1 feedback	1 = Encoder 1 used for speed feedback (see par. <a href="#">90.41</a> )																															
6	Encoder 2 feedback	1 = Encoder 2 used for speed feedback (see par. <a href="#">90.41</a> )																															
7	Any constant speed request	1 = A constant speed has been selected; see par. <a href="#">06.20</a> .																															
8...15	Reserved																																
	0000h...FFFFh	Speed control status word.	1 = 1																														
<a href="#">06.20</a>	<a href="#">Constant speed status word</a>	Constant speed status word. Indicates which constant speed is active (if any). See also parameter <a href="#">06.19 Speed control status word</a> , bit 7. This parameter is read-only.	-																														
		<table border="1"> <thead> <tr> <th>Bit</th> <th>Name</th> <th>Description</th> </tr> </thead> <tbody> <tr> <td>0</td> <td>Constant speed 1</td> <td>1 = Constant speed 1 selected</td> </tr> <tr> <td>1</td> <td>Constant speed 2</td> <td>1 = Constant speed 2 selected</td> </tr> <tr> <td>2</td> <td>Constant speed 3</td> <td>1 = Constant speed 3 selected</td> </tr> <tr> <td>3</td> <td>Constant speed 4</td> <td>1 = Constant speed 4 selected</td> </tr> <tr> <td>4</td> <td>Constant speed 5</td> <td>1 = Constant speed 5 selected</td> </tr> <tr> <td>5</td> <td>Constant speed 6</td> <td>1 = Constant speed 6 selected</td> </tr> <tr> <td>6</td> <td>Constant speed 7</td> <td>1 = Constant speed 7 selected</td> </tr> <tr> <td>7...15</td> <td>Reserved</td> <td></td> </tr> </tbody> </table>	Bit	Name	Description	0	Constant speed 1	1 = Constant speed 1 selected	1	Constant speed 2	1 = Constant speed 2 selected	2	Constant speed 3	1 = Constant speed 3 selected	3	Constant speed 4	1 = Constant speed 4 selected	4	Constant speed 5	1 = Constant speed 5 selected	5	Constant speed 6	1 = Constant speed 6 selected	6	Constant speed 7	1 = Constant speed 7 selected	7...15	Reserved					
Bit	Name	Description																															
0	Constant speed 1	1 = Constant speed 1 selected																															
1	Constant speed 2	1 = Constant speed 2 selected																															
2	Constant speed 3	1 = Constant speed 3 selected																															
3	Constant speed 4	1 = Constant speed 4 selected																															
4	Constant speed 5	1 = Constant speed 5 selected																															
5	Constant speed 6	1 = Constant speed 6 selected																															
6	Constant speed 7	1 = Constant speed 7 selected																															
7...15	Reserved																																
	0000h...FFFFh	Constant speed status word.	1 = 1																														
<a href="#">06.30</a>	<a href="#">User bit 0 selection</a>	Selects a binary source whose status is transmitted as bit 11 of <a href="#">06.11 Main status word</a> .	<a href="#">False</a>																														
	False	0.	1																														
	True	1.	2																														
	<a href="#">Other [bit]</a>	A specific bit in another parameter.	-																														
<a href="#">06.31</a>	<a href="#">User bit 1 selection</a>	Selects a binary source whose status is transmitted as bit 12 of <a href="#">06.11 Main status word</a> .	<a href="#">False</a>																														
	False	0.	1																														
	True	1.	2																														
	<a href="#">Other [bit]</a>	A specific bit in another parameter.	-																														
<a href="#">06.32</a>	<a href="#">User bit 2 selection</a>	Selects a binary source whose status is transmitted as bit 13 of <a href="#">06.11 Main status word</a> .	<a href="#">False</a>																														
	False	0.	1																														

No.	Name/Value	Description	Def/FbEq16
	True	1.	2
	<i>Other [bit]</i>	A specific bit in another parameter.	-
<b>06.33</b>	<b><i>User bit 3 selection</i></b>	Selects a binary source whose status is transmitted as bit 14 of <b>06.11 Main status word</b> .	<b><i>False</i></b>
	False	0.	1
	True	1.	2
	<i>Other [bit]</i>	A specific bit in another parameter.	-

<b>07 System info</b>		Drive hardware and firmware information. All parameters in this group are read-only.	
<b>07.03</b>	<b><i>Drive rating id</i></b>	Type of the drive/inverter unit.	-
<b>07.04</b>	<b><i>Firmware name</i></b>	Firmware identification.	-
<b>07.05</b>	<b><i>Firmware version</i></b>	Version number of the firmware.	-
<b>07.11</b>	<b><i>Cpu usage</i></b>	Microprocessor load in percent.	-
	0...100%	Microprocessor load.	1 = 1%

<b>10 Standard DI, RO</b>		Configuration of digital inputs and relay outputs.																			
<b>10.01</b>	<b><i>DI status</i></b>	Displays the electrical status of digital inputs DI1L and DI8...DI1. The activation/deactivation delays of the inputs (if any are specified) are ignored. Bits 0...5 reflect the status of DI1...DI6; bit 15 reflects the status of the DI1L input. <b>Example:</b> 1000000000010011 = DI1L, DI5, DI2 and DI1 are on, DI3, DI4 and DI6 are off. This parameter is read-only.	-																		
	0000h...FFFFh	Status of digital inputs.	1 = 1																		
<b>10.02</b>	<b><i>DI delayed status</i></b>	Displays the status of digital inputs DI1L and DI6...DI1. This word is updated only after activation/deactivation delays (if any are specified). Bits 0...5 reflect the delayed status of DI1...DI6; bit 15 reflects the delayed status of the DI1L input. This parameter is read-only.	-																		
	0000h...FFFFh	Delayed status of digital inputs.	1 = 1																		
<b>10.03</b>	<b><i>DI force selection</i></b>	The electrical statuses of the digital inputs can be overridden for eg. testing purposes. A bit in parameter <b>10.04 DI force data</b> is provided for each digital input, and its value is applied whenever the corresponding bit in this parameter is 1.	0000h																		
		<table border="1"> <thead> <tr> <th>Bit</th> <th>Value</th> </tr> </thead> <tbody> <tr> <td>0</td> <td>1 = Force DI1 to value of bit 0 of parameter <b>10.04 DI force data</b>.</td> </tr> <tr> <td>1</td> <td>1 = Force DI2 to value of bit 1 of parameter <b>10.04 DI force data</b>.</td> </tr> <tr> <td>2</td> <td>1 = Force DI3 to value of bit 2 of parameter <b>10.04 DI force data</b>.</td> </tr> <tr> <td>3</td> <td>1 = Force DI4 to value of bit 3 of parameter <b>10.04 DI force data</b>.</td> </tr> <tr> <td>4</td> <td>1 = Force DI5 to value of bit 4 of parameter <b>10.04 DI force data</b>.</td> </tr> <tr> <td>5</td> <td>1 = Force DI6 to value of bit 5 of parameter <b>10.04 DI force data</b>.</td> </tr> <tr> <td>6...14</td> <td>Reserved</td> </tr> <tr> <td>15</td> <td>1 = Force DI1L to value of bit 15 of parameter <b>10.04 DI force data</b>.</td> </tr> </tbody> </table>	Bit	Value	0	1 = Force DI1 to value of bit 0 of parameter <b>10.04 DI force data</b> .	1	1 = Force DI2 to value of bit 1 of parameter <b>10.04 DI force data</b> .	2	1 = Force DI3 to value of bit 2 of parameter <b>10.04 DI force data</b> .	3	1 = Force DI4 to value of bit 3 of parameter <b>10.04 DI force data</b> .	4	1 = Force DI5 to value of bit 4 of parameter <b>10.04 DI force data</b> .	5	1 = Force DI6 to value of bit 5 of parameter <b>10.04 DI force data</b> .	6...14	Reserved	15	1 = Force DI1L to value of bit 15 of parameter <b>10.04 DI force data</b> .	
Bit	Value																				
0	1 = Force DI1 to value of bit 0 of parameter <b>10.04 DI force data</b> .																				
1	1 = Force DI2 to value of bit 1 of parameter <b>10.04 DI force data</b> .																				
2	1 = Force DI3 to value of bit 2 of parameter <b>10.04 DI force data</b> .																				
3	1 = Force DI4 to value of bit 3 of parameter <b>10.04 DI force data</b> .																				
4	1 = Force DI5 to value of bit 4 of parameter <b>10.04 DI force data</b> .																				
5	1 = Force DI6 to value of bit 5 of parameter <b>10.04 DI force data</b> .																				
6...14	Reserved																				
15	1 = Force DI1L to value of bit 15 of parameter <b>10.04 DI force data</b> .																				
	0000h...FFFFh	Override selection for digital inputs.	1 = 1																		

No.	Name/Value	Description	Def/FbEq16
10.04	<i>DI force data</i>	Contains the values of digital inputs that are used instead of the electrical statuses if selected in parameter <a href="#">10.03 DI force selection</a> . Bit 0 is the forced value for DI1; bit 15 is the forced value for the DI1L input.	0000h
	0000h...FFFFh	Forced values of digital inputs.	1 = 1
10.05	<i>DI1 ON delay</i>	Defines the activation delay for digital input DI1.	0.0 s
	<p> <math>t_{On} = 10.05 \text{ DI1 ON delay}</math>  <math>t_{Off} = 10.06 \text{ DI1 OFF delay}</math>                      *Electrical status of digital input. Indicated by <a href="#">10.01 DI status</a>.                      **Indicated by <a href="#">10.02 DI delayed status</a>.                 </p>		
	0.0 ... 3000.0 s	Activation delay for DI1.	10 = 1 s
10.06	<i>DI1 OFF delay</i>	Defines the deactivation delay for digital input DI1. See parameter <a href="#">10.05 DI1 ON delay</a> .	0.0 s
	0.0 ... 3000.0 s	Deactivation delay for DI1.	10 = 1 s
10.07	<i>DI2 ON delay</i>	Defines the activation delay for digital input DI2.	0.0 s
	<p> <math>t_{On} = 10.07 \text{ DI2 ON delay}</math>  <math>t_{Off} = 10.08 \text{ DI2 OFF delay}</math>                      *Electrical status of digital input. Indicated by <a href="#">10.01 DI status</a>.                      **Indicated by <a href="#">10.02 DI delayed status</a>.                 </p>		
	0.0 ... 3000.0 s	Activation delay for DI2.	10 = 1 s
10.08	<i>DI2 OFF delay</i>	Defines the deactivation delay for digital input DI2. See parameter <a href="#">10.07 DI2 ON delay</a> .	0.0 s
	0.0 ... 3000.0 s	Deactivation delay for DI2.	10 = 1 s

No.	Name/Value	Description	Def/FbEq16
10.09	<i>DI3 ON delay</i>	Defines the activation delay for digital input DI3.	0.0 s
<p> <math>t_{On} = 10.09 \text{ DI3 ON delay}</math>  <math>t_{Off} = 10.10 \text{ DI3 OFF delay}</math>            *Electrical status of digital input. Indicated by <i>10.01 DI status</i>.            **Indicated by <i>10.02 DI delayed status</i>.         </p>			
	0.0 ... 3000.0 s	Activation delay for DI3.	10 = 1 s
10.10	<i>DI3 OFF delay</i>	Defines the deactivation delay for digital input DI3. See parameter <i>10.09 DI3 ON delay</i> .	0.0 s
	0.0 ... 3000.0 s	Deactivation delay for DI3.	10 = 1 s
10.11	<i>DI4 ON delay</i>	Defines the activation delay for digital input DI4.	0.0 s
<p> <math>t_{On} = 10.11 \text{ DI4 ON delay}</math>  <math>t_{Off} = 10.12 \text{ DI4 OFF delay}</math>            *Electrical status of digital input. Indicated by <i>10.01 DI status</i>.            **Indicated by <i>10.02 DI delayed status</i>.         </p>			
	0.0 ... 3000.0 s	Activation delay for DI4.	10 = 1 s
10.12	<i>DI4 OFF delay</i>	Defines the deactivation delay for digital input DI4. See parameter <i>10.11 DI4 ON delay</i> .	0.0 s
	0.0 ... 3000.0 s	Deactivation delay for DI4.	10 = 1 s

No.	Name/Value	Description	Def/FbEq16
10.13	<i>DI5 ON delay</i>	Defines the activation delay for digital input DI5.	0.0 s
<p><math>t_{On} = 10.13 \text{ DI5 ON delay}</math>  <math>t_{Off} = 10.14 \text{ DI5 OFF delay}</math>  *Electrical status of digital input. Indicated by 10.01 DI status.  **Indicated by 10.02 DI delayed status.</p>			
	0.0 ... 3000.0 s	Activation delay for DI5.	10 = 1 s
10.14	<i>DI5 OFF delay</i>	Defines the deactivation delay for digital input DI5. See parameter 10.13 DI5 ON delay.	0.0 s
	0.0 ... 3000.0 s	Deactivation delay for DI5.	10 = 1 s
10.15	<i>DI6 ON delay</i>	Defines the activation delay for digital input DI6.	0.0 s
<p><math>t_{On} = 10.15 \text{ DI6 ON delay}</math>  <math>t_{Off} = 10.16 \text{ DI6 OFF delay}</math>  *Electrical status of digital input. Indicated by 10.01 DI status.  **Indicated by 10.02 DI delayed status.</p>			
	0.0 ... 3000.0 s	Activation delay for DI6.	10 = 1 s
10.16	<i>DI6 OFF delay</i>	Defines the deactivation delay for digital input DI6. See parameter 10.15 DI6 ON delay.	0.0 s
	0.0 ... 3000.0 s	Deactivation delay for DI6.	10 = 1 s
10.21	<i>RO status</i>	Status of relay outputs RO8...RO1. <b>Example:</b> 00000001b = RO1 is energized, RO2...RO8 are de-energized.	-
	0000h...FFFFh	Status of relay outputs.	1 = 1
10.24	<i>RO1 source</i>	Selects a drive signal to be connected to relay output RO1.	<i>Ready run</i>
	Not energized	Output is not energized.	0
	Energized	Output is energized.	1
	Ready run	Bit 1 of 06.11 Main status word (see page 88).	2
	Enabled	Bit 0 of 06.16 Drive status word 1 (see page 88).	4
	Started	Bit 5 of 06.16 Drive status word 1 (see page 88).	5
	Magnetized	Bit 1 of 06.17 Drive status word 2 (see page 89).	6
	Running	Bit 4 of 06.16 Drive status word 1 (see page 88).	7

No.	Name/Value	Description	Def/FbEq16
	Ready ref	Bit 2 of <a href="#">06.11 Main status word</a> (see page 88).	8
	At setpoint	Bit 8 of <a href="#">06.11 Main status word</a> (see page 88).	9
	Reverse	Bit 2 of <a href="#">06.19 Speed control status word</a> (see page 90).	10
	Zero speed	Bit 0 of <a href="#">06.19 Speed control status word</a> (see page 90).	11
	Above speed limit	Bit 10 of <a href="#">06.11 Main status word</a> (see page 88).	12
	Warning	Bit 7 of <a href="#">06.11 Main status word</a> (see page 88).	13
	Fault	Bit 3 of <a href="#">06.11 Main status word</a> (see page 88).	14
	Fault (-1)	Inverted bit 3 of <a href="#">06.11 Main status word</a> (see page 88).	15
	Brake command	Bit 0 of <a href="#">44.01 Brake control status</a> (see page 217).	22
	Ext2 active	Bit 11 of <a href="#">06.16 Drive status word 1</a> (see page 88).	23
	Ext control	Bit 9 of <a href="#">06.11 Main status word</a> (see page 88).	24
	Supervision 1	Bit 0 of <a href="#">32.01 Supervision status</a> (see page 183).	33
	Supervision 2	Bit 1 of <a href="#">32.01 Supervision status</a> (see page 183).	34
	Supervision 3	Bit 2 of <a href="#">32.01 Supervision status</a> (see page 183).	35
	<i>Other [bit]</i>	A specific bit in another parameter.	-
<a href="#">10.25</a>	<a href="#">RO1 ON delay</a>	Defines the activation delay for relay output RO1.	0.0 s
<p> <math>t_{On} = \text{10.25 RO1 ON delay}</math>  <math>t_{Off} = \text{10.26 RO1 OFF delay}</math> </p>			
	0.0 ... 3000.0 s	Activation delay for RO1.	10 = 1 s
<a href="#">10.26</a>	<a href="#">RO1 OFF delay</a>	Defines the deactivation delay for relay output RO1. See parameter <a href="#">10.25 RO1 ON delay</a> .	0.0 s
	0.0 ... 3000.0 s	Deactivation delay for RO1.	10 = 1 s

No.	Name/Value	Description	Def/FbEq16
10.27	<i>RO2 source</i>	Selects a drive signal to be connected to relay output RO2. For the available selections, see parameter <a href="#">10.24 RO1 source</a> .	<i>Running</i>
10.28	<i>RO2 ON delay</i>	Defines the activation delay for relay output RO2.	0.0 s
<p> <math>t_{On} = 10.28 \text{ RO2 ON delay}</math>  <math>t_{Off} = 10.29 \text{ RO2 OFF delay}</math> </p>			
	0.0 ... 3000.0 s	Activation delay for RO2.	10 = 1 s
10.29	<i>RO2 OFF delay</i>	Defines the deactivation delay for relay output RO2. See parameter <a href="#">10.28 RO2 ON delay</a> .	0.0 s
	0.0 ... 3000.0 s	Deactivation delay for RO2.	10 = 1 s
10.30	<i>RO3 source</i>	Selects a drive signal to be connected to relay output RO3. For the available selections, see parameter <a href="#">10.24 RO1 source</a> .	<i>Fault (-1)</i>
10.31	<i>RO3 ON delay</i>	Defines the activation delay for relay output RO3.	0.0 s
<p> <math>t_{On} = 10.31 \text{ RO3 ON delay}</math>  <math>t_{Off} = 10.32 \text{ RO3 OFF delay}</math> </p>			
	0.0 ... 3000.0 s	Activation delay for RO3.	10 = 1 s
10.32	<i>RO3 OFF delay</i>	Defines the deactivation delay for relay output RO3. See parameter <a href="#">10.31 RO3 ON delay</a> .	0.0 s
	0.0 ... 3000.0 s	Deactivation delay for RO3.	10 = 1 s
<b>11 Standard DIO, FI, FO</b> Configuration of digital input/outputs and frequency inputs/outputs.			
11.01	<i>DIO status</i>	Displays the electrical status of digital input/outputs DIO8...DIO1. The activation/deactivation delays (if any are specified) are ignored. <b>Example:</b> 000001001 = DIO1 and DIO4 are on, remainder are off. This parameter is read-only.	-
	0000h...FFFFh	Status of digital input/outputs.	1 = 1



No.	Name/Value	Description	Def/FbEq16
11.02	<i>DIO delayed status</i>	Displays the status of digital input/outputs DIO8...DIO1. This word is updated only after activation/deactivation delays (if any are specified). <b>Example:</b> 0000001001 = DIO1 and DIO4 are on, remainder are off. This parameter is read-only.	-
	0000h...FFFFh	Delayed status of digital input/outputs.	1 = 1
11.05	<i>DIO1 configuration</i>	Selects whether DIO1 is used as a digital output or input, or a frequency input.	<i>Output</i>
	Output	DIO1 is used as a digital output.	0
	Input	DIO1 is used as a digital input.	1
	Frequency	DIO1 is used as a frequency input.	2
11.06	<i>DIO1 output source</i>	Selects a drive signal to be connected to digital input/output DIO1 when parameter <i>11.05 DIO1 configuration</i> is set to <i>Output</i> .	<i>Ready run</i>
	Not energized	Output is not energized.	0
	Energized	Output is energized.	1
	Ready run	Bit 1 of <i>06.11 Main status word</i> (see page 88).	2
	Enabled	Bit 0 of <i>06.16 Drive status word 1</i> (see page 88).	4
	Started	Bit 5 of <i>06.16 Drive status word 1</i> (see page 88).	5
	Magnetized	Bit 1 of <i>06.17 Drive status word 2</i> (see page 89).	6
	Running	Bit 4 of <i>06.16 Drive status word 1</i> (see page 88).	7
	Ready ref	Bit 2 of <i>06.11 Main status word</i> (see page 88).	8
	At setpoint	Bit 8 of <i>06.11 Main status word</i> (see page 88).	9
	Reverse	Bit 2 of <i>06.19 Speed control status word</i> (see page 90).	10
	Zero speed	Bit 0 of <i>06.19 Speed control status word</i> (see page 90).	11
	Above speed limit	Bit 10 of <i>06.11 Main status word</i> (see page 88).	12
	Warning	Bit 7 of <i>06.11 Main status word</i> (see page 88).	13
	Fault	Bit 3 of <i>06.11 Main status word</i> (see page 88).	14
	Fault (-1)	Inverted bit 3 of <i>06.11 Main status word</i> (see page 88).	15
	Brake command	Bit 0 of <i>44.01 Brake control status</i> (see page 217).	22
	Ext2 active	Bit 11 of <i>06.16 Drive status word 1</i> (see page 88).	23
	Ext control	Bit 9 of <i>06.11 Main status word</i> (see page 88).	24
	Supervision 1	Bit 0 of <i>32.01 Supervision status</i> (see page 183).	33
	Supervision 2	Bit 1 of <i>32.01 Supervision status</i> (see page 183).	34
	Supervision 3	Bit 2 of <i>32.01 Supervision status</i> (see page 183).	35
	<i>Other [bit]</i>	A specific bit in another parameter.	-

No.	Name/Value	Description	Def/FbEq16
11.07	<a href="#">DIO1 ON delay</a>	Defines the activation delay for digital input/output DIO1 (when used as a digital output or digital input).	0.0 s
		<p><math>t_{On} = 11.07</math> <a href="#">DIO1 ON delay</a>  <math>t_{Off} = 11.08</math> <a href="#">DIO1 OFF delay</a>                      *Electrical status of DIO (in input mode) or status of selected source (in output mode). Indicated by <a href="#">11.01 DIO status</a>.                      **Indicated by <a href="#">11.02 DIO delayed status</a>.</p>	
	0.0 ... 3000.0 s	Activation delay for DIO1.	10 = 1 s
11.08	<a href="#">DIO1 OFF delay</a>	Defines the deactivation delay for digital input/output DIO1 (when used as a digital output or digital input). See parameter <a href="#">11.07 DIO1 ON delay</a> .	0.0 s
	0.0 ... 3000.0 s	Deactivation delay for DIO1.	10 = 1 s
11.09	<a href="#">DIO2 configuration</a>	Selects whether DIO2 is used as a digital output or input, or a frequency output.	<a href="#">Output</a>
	Output	DIO2 is used as a digital output.	0
	Input	DIO2 is used as a digital input.	1
	Frequency	DIO2 is used as a frequency output.	2
11.10	<a href="#">DIO2 output source</a>	Selects a drive signal to be connected to digital input/output DIO2 when parameter <a href="#">11.09 DIO2 configuration</a> is set to <a href="#">Output</a> . For the available selections, see parameter <a href="#">11.06 DIO1 output source</a> .	<a href="#">Running</a>
11.11	<a href="#">DIO2 ON delay</a>	Defines the activation delay for digital input/output DIO2 (when used as a digital output or digital input).	0.0 s
		<p><math>t_{On} = 11.11</math> <a href="#">DIO2 ON delay</a>  <math>t_{Off} = 11.12</math> <a href="#">DIO2 OFF delay</a>                      *Electrical status of DIO (in input mode) or status of selected source (in output mode). Indicated by <a href="#">11.01 DIO status</a>.                      **Indicated by <a href="#">11.02 DIO delayed status</a>.</p>	
	0.0 ... 3000.0 s	Activation delay for DIO2.	10 = 1 s
11.12	<a href="#">DIO2 OFF delay</a>	Defines the deactivation delay for digital input/output DIO2 (when used as a digital output or digital input). See parameter <a href="#">11.11 DIO2 ON delay</a> .	0.0 s
	0.0 ... 3000.0 s	Deactivation delay for DIO2.	10 = 1 s

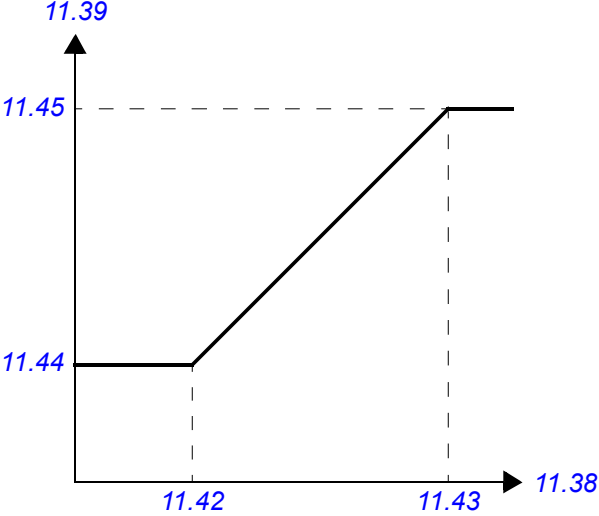
No.	Name/Value	Description	Def/FbEq16
11.38	<i>Freq in 1 actual value</i>	Displays the value of frequency input 1 before scaling. See parameter <a href="#">11.42 Freq in 1 min.</a> This parameter is read-only.	-
	0 ... 16000 Hz	Unscaled value of frequency input 1.	1 = 1 Hz
11.39	<i>Freq in 1 scaled</i>	Displays the value of frequency input 1 after scaling. See parameter <a href="#">11.42 Freq in 1 min.</a> This parameter is read-only.	-
	-32768.000 ... 32767.000	Scaled value of frequency input 1.	1 = 1
11.42	<i>Freq in 1 min</i>	Defines the minimum input frequency for frequency input 1 (DIO1 when it is used as a frequency input). The incoming frequency signal ( <a href="#">11.38 Freq in 1 actual value</a> ) is scaled into an internal signal ( <a href="#">11.39 Freq in 1 scaled</a> ) by parameters <a href="#">11.42</a> ... <a href="#">11.45</a> as follows: 	0 Hz
	0 ... 16000 Hz	Minimum frequency of frequency input 1 (DIO1).	1 = 1 Hz
11.43	<i>Freq in 1 max</i>	Defines the maximum input frequency for frequency input 1 (DIO1 when it is used as a frequency input). See parameter <a href="#">11.42 Freq in 1 min.</a>	16000 Hz
	0 ... 16000 Hz	Maximum frequency for frequency input 1 (DIO1).	1 = 1 Hz
11.44	<i>Freq in 1 scaled at min</i>	Defines the value that corresponds to the minimum input frequency defined by parameter <a href="#">11.42 Freq in 1 min.</a> See diagram at parameter <a href="#">11.42 Freq in 1 min.</a>	0.000
	-32768.000 ... 32767.000	Value corresponding to minimum of frequency input 1.	1 = 1
11.45	<i>Freq in 1 scaled at max</i>	Defines the value that corresponds to the maximum input frequency defined by parameter <a href="#">11.43 Freq in 1 max.</a> See diagram at parameter <a href="#">11.42 Freq in 1 min.</a>	1500.000
	-32768.000 ... 32767.000	Value corresponding to maximum of frequency input 1.	1 = 1
11.54	<i>Freq out 1 actual value</i>	Displays the value of frequency output 1 after scaling. See parameter <a href="#">11.58 Freq out 1 src min.</a> This parameter is read-only.	-
	0 ... 16000 Hz	Value of frequency output 1.	1 = 1

## 100 Parameters

No.	Name/Value	Description	Def/FbEq16
11.55	<i>Freq out 1 source</i>	Selects a signal to be connected to frequency output 1.	<i>Motor speed used</i>
	Zero	None.	0
	Motor speed used	<a href="#">01.01 Motor speed used</a> (page 84).	1
	Output frequency	<a href="#">01.06 Output frequency</a> (page 84).	3
	Motor current	<a href="#">01.07 Motor current</a> (page 84).	4
	Motor torque	<a href="#">01.10 Motor torque %</a> (page 84).	6
	Dc-voltage	<a href="#">01.11 DC voltage</a> (page 84).	7
	Power inu out	<a href="#">01.14 Output power</a> (page 84).	8
	Speed ref ramp in	<a href="#">23.01 Speed ref ramp in</a> (page 151).	10
	Speed ref ramped	<a href="#">23.02 Speed ref ramp out</a> (page 151).	11
	Speed ref used	<a href="#">24.01 Used speed reference</a> (page 155).	12
	Torq ref used	<a href="#">26.02 Torque ref used</a> (page 164).	13
	Freq ref used	<a href="#">28.02 Frequency ref ramp out</a> (page 168).	14
	Process PID out	<a href="#">40.01 Process PID actual value</a> (page 203).	16
	Process PID fbk	<a href="#">40.02 Feedback actual value</a> (page 203).	17
	Process PID act	<a href="#">40.03 Setpoint actual value</a> (page 203).	18
	Process PID dev	<a href="#">40.04 Deviation actual value</a> (page 203).	19
	Other	The value is taken from another parameter.	-

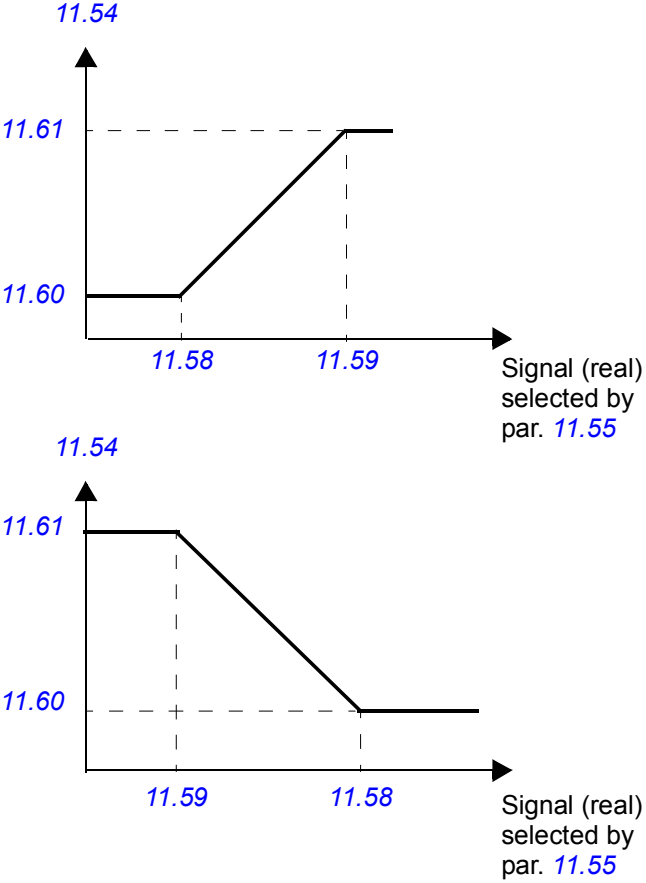
No.	Name/Value	Description	Def/FbEq16
11.58	<i>Freq out 1 src min</i>	Defines the real value of the signal (selected by parameter <a href="#">11.55 Freq out 1 source</a> and shown by parameter <a href="#">11.54 Freq out 1 actual value</a> ) that corresponds to the minimum value of frequency output 1 (defined by parameter <a href="#">11.60 Freq out 1 at src min</a> ).  	0.000
-32768.000 ... 32767.000	Real signal value corresponding to minimum value of frequency output 1.	1 = 1	
11.59	<i>Freq out 1 src max</i>	Defines the real value of the signal (selected by parameter <a href="#">11.55 Freq out 1 source</a> and shown by parameter <a href="#">11.54 Freq out 1 actual value</a> ) that corresponds to the maximum value of frequency output 1 (defined by parameter <a href="#">11.61 Freq out 1 at src max</a> ). See parameter <a href="#">11.58 Freq out 1 src min</a> .	1500.000
-32768.000 ... 32767.000	Real signal value corresponding to maximum value of frequency output 1.	1 = 1	
11.60	<i>Freq out 1 at src min</i>	Defines the minimum value of frequency output 1. See diagrams at parameter <a href="#">11.58 Freq out 1 src min</a> .	0 Hz
0...16000 Hz	Minimum value of frequency output 1.	1 = 1 Hz	
11.61	<i>Freq out 1 at src max</i>	Defines the maximum value of frequency output 1. See diagrams at parameter <a href="#">11.58 Freq out 1 src min</a> .	16000 Hz
0...16000 Hz	Maximum value of frequency output 1.	1 = 1 Hz	

## 102 Parameters

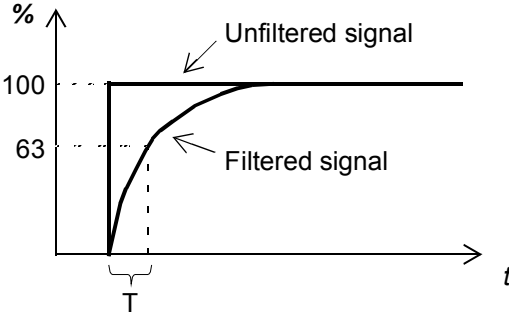
No.	Name/Value	Description	Def/FbEq16
<b>12 Standard AI</b>		Configuration of analog inputs.	
12.11	<i>AI1 actual value</i>	Displays the value of analog input AI1 in mA or V (depending on whether the input is set to current or voltage by jumper J1). This parameter is read-only.	-
	-22.000 ... 22.000 mA or V	Value of analog input AI1.	1000 = 1 mA or V
12.12	<i>AI1 scaled value</i>	Displays the value of analog input AI1 after scaling. See parameters <a href="#">12.19 AI1 scaled at AI1 min</a> and <a href="#">12.20 AI1 scaled at AI1 max</a> . This parameter is read-only.	-
	-32768.000 ... 32767.000	Scaled value of analog input AI1.	1 = 1
12.15	<i>AI1 unit selection</i>	Selects the unit for readings and settings related to analog input AI1. <b>Note:</b> This setting must match the corresponding jumper setting on the drive control unit (see the hardware manual of the drive). Control board reboot (either by cycling the power or through parameter <a href="#">96.08 Control board boot</a> ) is required to validate any changes in the jumper settings.	V
	V	Volts.	2
	mA	Milliamperes.	10
12.16	<i>AI1 filter time</i>	Defines the filter time constant for analog input AI1.  $O = I \times (1 - e^{-t/T})$ I = filter input (step) O = filter output t = time T = filter time constant <b>Note:</b> The signal is also filtered due to the signal interface hardware (approximately 0.25 ms time constant). This cannot be changed by any parameter.	0.100 s
	0.000 ... 30.000 s	Filter time constant.	1000 = 1 s
12.17	<i>AI1 min</i>	Defines the minimum value for analog input AI1.	0.000 mA or V
	-22.000 ... 22.000 mA or V	Minimum value of AI1.	1000 = 1 mA or V

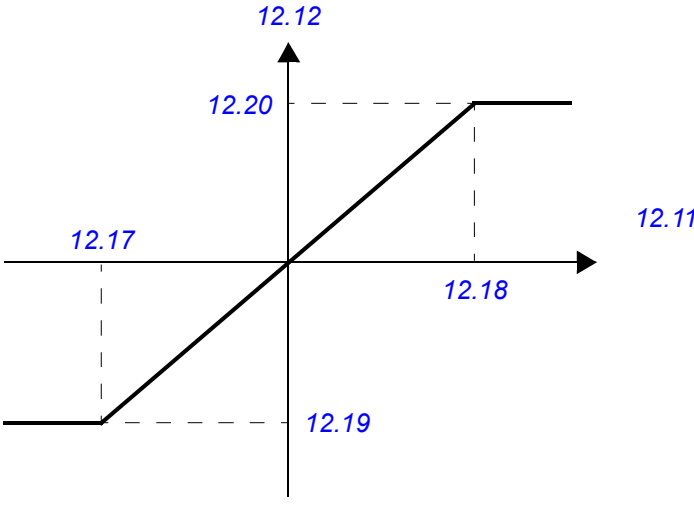
No.	Name/Value	Description	Def/FbEq16
12.18	<i>AI1 max</i>	Defines the maximum value for analog input AI1.	20.000 mA or 10.000 V
	-22.000 ... 22.000 mA or V	Maximum value of AI1.	1000 = 1 mA or V
12.19	<i>AI1 scaled at AI1 min</i>	Defines the real value that corresponds to the minimum analog input AI1 value defined by parameter <a href="#">12.17 AI1 min</a> . 	0.000
	-32768.000 ... 32767.000	Real value corresponding to minimum AI1 value.	1 = 1
12.20	<i>AI1 scaled at AI1 max</i>	Defines the real value that corresponds to the maximum analog input AI1 value defined by parameter <a href="#">12.18 AI1 max</a> . See the drawing at parameter <a href="#">12.19 AI1 scaled at AI1 min</a> .	1500.0
	-32768.000 ... 32767.000	Real value corresponding to maximum AI1 value.	1 = 1
12.21	<i>AI2 actual value</i>	Displays the value of analog input AI2 in mA or V (depending on whether the input is set to current or voltage by jumper J2). This parameter is read-only.	-
	-22.000 ... 22.000 mA or V	Value of analog input AI2.	1000 = 1 mA or V
12.22	<i>AI2 scaled value</i>	Displays the value of analog input AI2 after scaling. See parameters <a href="#">12.29 AI2 scaled at AI2 min</a> and <a href="#">12.30 AI2 scaled at AI2 max</a> . This parameter is read-only.	-
	-32768.000 ... 32767.000	Scaled value of analog input AI2.	1 = 1
12.25	<i>AI2 unit selection</i>	Selects the unit for readings and settings related to analog input AI2. <b>Note:</b> This setting must match the corresponding jumper setting on the drive control unit (see the hardware manual of the drive). Control board reboot (either by cycling the power or through parameter <a href="#">96.08 Control board boot</a> ) is required to validate any changes in the jumper settings.	<i>mA</i>
	V	Volts.	2
	mA	Milliamperes.	10
12.26	<i>AI2 filter time</i>	Defines the filter time constant for analog input AI2. See parameter <a href="#">12.16 AI1 filter time</a> .	0.100 s
	0.000 ... 30.000 s	Filter time constant.	1000 = 1 s

## 104 Parameters

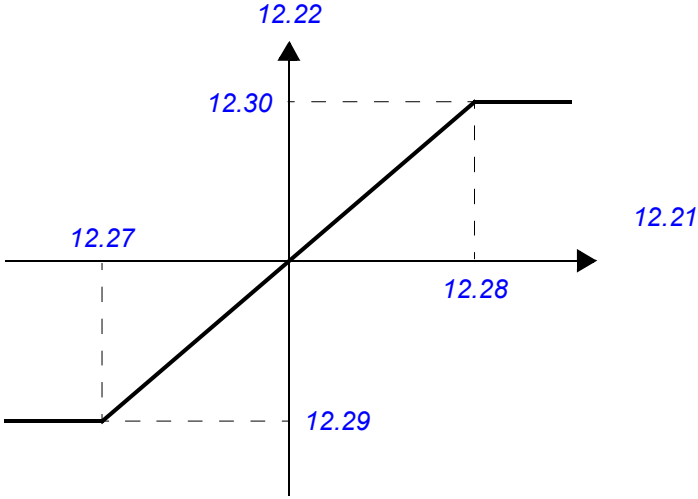
No.	Name/Value	Description	Def/FbEq16
12.27	<i>AI2 min</i>	Defines the minimum value for analog input AI2.	0.000 mA or V
	-22.000 ... 22.000 mA or V	Minimum value of AI2.	1000 = 1 mA or V
12.28	<i>AI2 max</i>	Defines the maximum value for analog input AI2.	20.000 mA or 10.000 V
	-22.000 ... 22.000 mA or V	Maximum value of AI2.	1000 = 1 mA or V
12.29	<i>AI2 scaled at AI2 min</i>	Defines the real value that corresponds to the minimum analog input AI2 value defined by parameter <i>12.27 AI2 min</i> .	0.000
			
	-32768.000 ... 32767.000	Real value corresponding to minimum AI2 value.	1 = 1
12.30	<i>AI2 scaled at AI2 max</i>	Defines the real value that corresponds to the maximum analog input AI2 value defined by parameter <i>12.28 AI2 max</i> . See the drawing at parameter <i>12.29 AI2 scaled at AI2 min</i> .	100.000
	-32768.000 ... 32767.000	Real value corresponding to maximum AI2 value.	1 = 1

<b>13 Standard AO</b>		Configuration of analog outputs.	
13.11	<i>AO1 actual value</i>	Displays the value of AO1 in mA. This parameter is read-only.	-
	0.000 ... 22.000 mA	Value of AO1.	1000 = 1 mA
13.12	<i>AO1 source</i>	Selects a signal to be connected to analog output AO1. Alternatively, sets the output to excitation mode to feed a constant current to a temperature sensor.	<i>Motor speed used</i>
	Zero	None.	0
	Motor speed used	<i>01.01 Motor speed used</i> (page 84).	1
	Output frequency	<i>01.06 Output frequency</i> (page 84).	3
	Motor current	<i>01.07 Motor current</i> (page 84).	4
	Motor torque	<i>01.10 Motor torque %</i> (page 84).	6
	DC voltage	<i>01.11 DC voltage</i> (page 84).	7
	Power inu out	<i>01.14 Output power</i> (page 84).	8
	Speed ref ramp in	<i>23.01 Speed ref ramp in</i> (page 151).	10

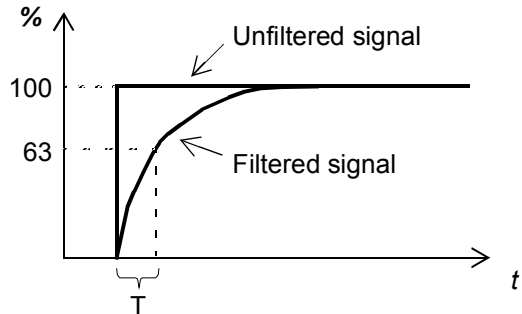

No.	Name/Value	Description	Def/FbEq16
	Speed ref ramp out	<a href="#">23.02 Speed ref ramp out</a> (page 151).	11
	Speed ref used	<a href="#">24.01 Used speed reference</a> (page 155).	12
	Torq ref used	<a href="#">26.02 Torque ref used</a> (page 164).	13
	Freq ref used	<a href="#">28.02 Frequency ref ramp out</a> (page 168).	14
	Process PID out	<a href="#">40.01 Process PID actual value</a> (page 203).	16
	Process PID fbk	<a href="#">40.02 Feedback actual value</a> (page 203).	17
	Process PID act	<a href="#">40.03 Setpoint actual value</a> (page 203).	18
	Process PID dev	<a href="#">40.04 Deviation actual value</a> (page 203).	19
	Force PT100 excitation	The output is used to feed an excitation current to 1...3 Pt100 sensors. See section <a href="#">Motor thermal protection</a> (page 56).	20
	Force KTY84 excitation	The output is used to feed an excitation current to a KTY84 sensor. See section <a href="#">Motor thermal protection</a> (page 56).	21
	Other	The value is taken from another parameter.	-
<b>13.16</b>	<b>AO1 filter time</b>	<p>Defines the filtering time constant for analog output AO1.</p>  $O = I \times (1 - e^{-t/T})$ <p>           I = filter input (step)            O = filter output            t = time            T = filter time constant         </p>	0.100 s
	0.000 ... 30.000 s	Filter time constant.	1000 = 1 s

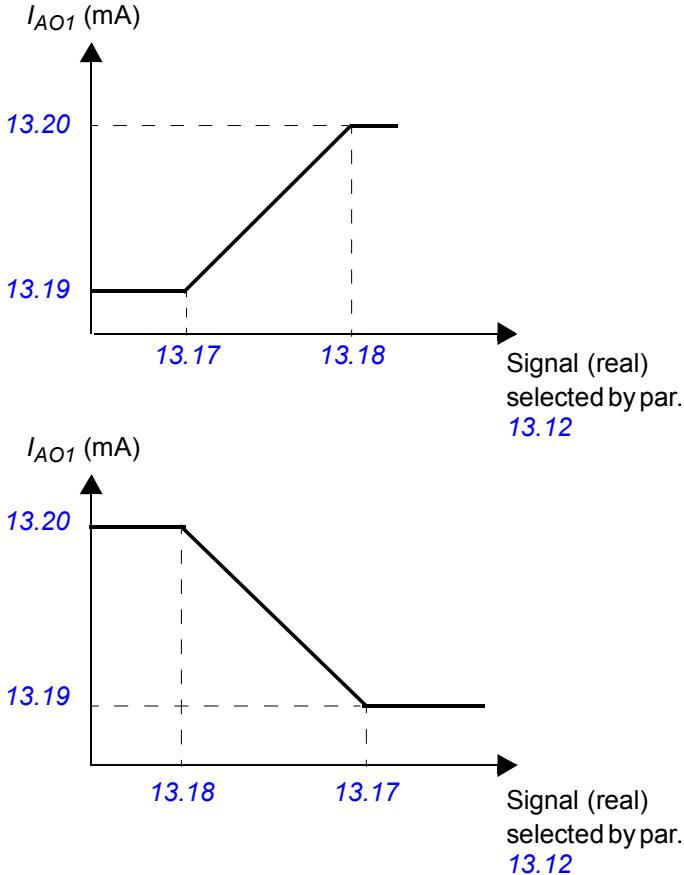
No.	Name/Value	Description	Def/FbEq16
13.17	<i>AO1 source min</i>	<p>Defines the real value of the signal (selected by parameter <a href="#">13.12 AO1 source</a>) that corresponds to the minimum AO1 output value (defined by parameter <a href="#">13.19 AO1 out at AO1 src min</a>).</p> 	0.0
-32768.0 ... 32767.0	Real signal value corresponding to minimum AO1 output value.	1 = 1	
13.18	<i>AO1 source max</i>	<p>Defines the real value of the signal (selected by parameter <a href="#">13.12 AO1 source</a>) that corresponds to the maximum AO1 output value (defined by parameter <a href="#">13.20 AO1 out at AO1 src max</a>). See parameter <a href="#">13.17 AO1 source min</a>.</p>	1500.0
-32768.0 ... 32767.0	Real signal value corresponding to maximum AO1 output value.	1 = 1	
13.19	<i>AO1 out at AO1 src min</i>	<p>Defines the minimum output value for analog output AO1. See also drawing at parameter <a href="#">13.17 AO1 source min</a>.</p>	0.000 mA
0.000 ... 22.000 mA	Minimum AO1 output value.	1000 = 1 mA	
13.20	<i>AO1 out at AO1 src max</i>	<p>Defines the maximum output value for analog output AO1. See also drawing at parameter <a href="#">13.17 AO1 source min</a>.</p>	20.000 mA
0.000 ... 22.000 mA	Maximum AO1 output value.	1000 = 1 mA	
13.21	<i>AO2 actual value</i>	<p>Displays the value of AO2 in mA. This parameter is read-only.</p>	-
0.000 ... 22.000 mA	Value of AO2.	1000 = 1 mA	
13.22	<i>AO2 source</i>	<p>Selects a signal to be connected to analog output AO2. Alternatively, sets the output to excitation mode to feed a constant current to a temperature sensor. For the selections, see parameter <a href="#">13.12 AO1 source</a>.</p>	<i>Motor current</i>

No.	Name/Value	Description	Def/FbEq16
13.26	<i>AO2 filter time</i>	Defines the filtering time constant for analog output AO2. See parameter <i>13.16 AO1 filter time</i> .	0.100 s
	0.000 ... 30.000 s	Filter time constant.	1000 = 1 s
13.27	<i>AO2 source min</i>	Defines the real value of the signal (selected by parameter <i>13.22 AO2 source</i> ) that corresponds to the minimum AO2 output value (defined by parameter <i>13.29 AO2 out at AO2 src min</i> ).	0.0
		<p>The figure contains two graphs. Both graphs have <math>I_{AO2}</math> (mA) on the vertical axis and 'Signal (real) selected by par. 13.22' on the horizontal axis. The top graph shows a signal value increasing from 13.27 to 13.28. The output current <math>I_{AO2}</math> is constant at 13.29 mA for the first part of the signal range, then increases linearly to 13.30 mA at signal value 13.28, and remains constant at 13.30 mA for higher signal values. The bottom graph shows a signal value decreasing from 13.28 to 13.27. The output current <math>I_{AO2}</math> is constant at 13.30 mA for the first part of the signal range, then decreases linearly to 13.29 mA at signal value 13.27, and remains constant at 13.29 mA for lower signal values.</p>	
	-32768.0 ... 32767.0	Real signal value corresponding to minimum AO2 output value.	1 = 1
13.28	<i>AO2 source max</i>	Defines the real value of the signal (selected by parameter <i>13.22 AO2 source</i> ) that corresponds to the maximum AO2 output value (defined by parameter <i>13.30 AO2 out at AO2 src max</i> ). See parameter <i>13.27 AO2 source min</i> .	100.0
	-32768.0 ... 32767.0	Real signal value corresponding to maximum AO2 output value.	1 = 1
13.29	<i>AO2 out at AO2 src min</i>	Defines the minimum output value for analog output AO2. See also drawing at parameter <i>13.27 AO2 source min</i> .	0.000 mA
	0.000 ... 22.000 mA	Minimum AO2 output value.	1000 = 1 mA
13.30	<i>AO2 out at AO2 src max</i>	Defines the maximum output value for analog output AO2. See also drawing at parameter <i>13.27 AO2 source min</i> .	20.000 mA
	0.000 ... 22.000 mA	Maximum AO2 output value.	1000 = 1 mA

No.	Name/Value	Description	Def/FbEq16
<b>14 I/O extension module 1</b>		Configuration of I/O extension module 1. See also section <i>Programmable I/O extensions</i> (page 27). <b>Note:</b> The contents of the parameter group vary according to the selected I/O extension module type.	
<b>14.01</b>	<b>Module 1 type</b>	Activates (and specifies the type of) I/O extension module 1.	<i>None</i>
	None	Inactive.	0
	FIO-01	FIO-01.	1
	FIO-11	FIO-11.	2
<b>14.02</b>	<b>Module 1 location</b>	Specifies the slot (1...3) on the control unit of the drive into which the I/O extension module is installed.	1 (Slot 1)
	1...254	Slot number.	-
<b>14.03</b>	<b>Module 1 status</b>	Displays the status of I/O extension module 1.	<i>No option</i>
	No option	No module detected in the specified slot.	0
	No communication	A module has been detected but cannot be communicated with.	1
	Unknown	The module type is unknown.	2
	FIO-01	An FIO-01 module has been detected and is active.	3
	FIO-11	An FIO-11 module has been detected and is active.	4
<b>14.05</b>	<b>DIO status</b>	Displays the electrical status of the digital input/outputs on the extension module. The activation/deactivation delays (if any are specified) are ignored. Bit 0 indicates the status of DIO1. <b>Note:</b> The number of active bits in this parameter depends on the number of digital input/outputs on the extension module. <b>Example:</b> 00001001 = DIO1 and DIO4 are on, remainder are off. This parameter is read-only.	-
	0000h...FFFFh	Status of digital input/outputs.	1 = 1
<b>14.06</b>	<b>DIO delayed status</b>	Displays the status of the digital input/outputs on the extension module. This word is updated only after activation/deactivation delays (if any are specified). Bit 0 indicates the status of DIO1. <b>Note:</b> The number of active bits in this parameter depends on the number of digital input/outputs on the extension module. <b>Example:</b> 0000001001 = DIO1 and DIO4 are on, remainder are off. This parameter is read-only.	-
	0000h...FFFFh	Delayed status of digital input/outputs.	1 = 1
<b>14.09</b>	<b>DIO1 configuration</b>	Selects whether DIO1 of the extension module is used as a digital input or output.	<i>Input</i>
	Input	DIO1 is used as a digital input.	0
	Output	DIO1 is used as a digital output.	1
<b>14.10</b>	<b>DIO1 filter gain</b>	(Visible when <b>14.01 Module 1 type</b> = FIO-11) Determines a filtering time for DIO1 when it is used as an input.	<i>7.5 us</i>
	7.5 us	7.5 microseconds.	0
	195 us	195 microseconds.	1
	780 us	780 microseconds.	2

No.	Name/Value	Description	Def/FbEq16
	4.680 ms	4.680 milliseconds.	3
<b>14.11</b>	<b>DIO1 output source</b>	Selects a drive signal to be connected to digital input/output DIO1 of the extension module when parameter <b>14.09 DIO1 configuration</b> is set to <b>Output</b> .	<i>Not energized</i>
	Not energized	Output is not energized.	0
	Energized	Output is energized.	1
	Ready run	Bit 1 of <b>06.11 Main status word</b> (see page 88).	2
	Enabled	Bit 0 of <b>06.16 Drive status word 1</b> (see page 88).	4
	Started	Bit 5 of <b>06.16 Drive status word 1</b> (see page 88).	5
	Magnetized	Bit 1 of <b>06.17 Drive status word 2</b> (see page 89).	6
	Running	Bit 4 of <b>06.16 Drive status word 1</b> (see page 88).	7
	Ready ref	Bit 2 of <b>06.11 Main status word</b> (see page 88).	8
	At setpoint	Bit 8 of <b>06.11 Main status word</b> (see page 88).	9
	Reverse	Bit 2 of <b>06.19 Speed control status word</b> (see page 90).	10
	Zero speed	Bit 0 of <b>06.19 Speed control status word</b> (see page 90).	11
	Above speed limit	Bit 10 of <b>06.11 Main status word</b> (see page 88).	12
	Warning	Bit 7 of <b>06.11 Main status word</b> (see page 88).	13
	Fault	Bit 3 of <b>06.11 Main status word</b> (see page 88).	14
	Fault (-1)	Inverted bit 3 of <b>06.11 Main status word</b> (see page 88).	15
	Brake command	Bit 0 of <b>44.01 Brake control status</b> (see page 217).	22
	Ext2 active	Bit 11 of <b>06.16 Drive status word 1</b> (see page 88).	23
	Ext control	Bit 9 of <b>06.11 Main status word</b> (see page 88).	24
	Supervision 1	Bit 0 of <b>32.01 Supervision status</b> (see page 183).	33
	Supervision 2	Bit 1 of <b>32.01 Supervision status</b> (see page 183).	34
	Supervision 3	Bit 2 of <b>32.01 Supervision status</b> (see page 183).	35
	<i>Other [bit]</i>	A specific bit in another parameter.	-
<b>14.12</b>	<b>DIO1 ON delay</b>	Defines the activation delay for digital input/output DIO1.	0.0 s
<p> <math>t_{On}</math> = <b>14.12 DIO1 ON delay</b>  <math>t_{Off}</math> = <b>14.13 DIO1 OFF delay</b>  *Electrical status of DIO (in input mode) or status of selected source (in output mode). Indicated by <b>14.05 DIO status</b>.  **Indicated by <b>14.06 DIO delayed status</b>. </p>			
	0.0 ... 3000.0 s	Activation delay for DIO1.	10 = 1 s
<b>14.13</b>	<b>DIO1 OFF delay</b>	Defines the deactivation delay for digital input/output DIO1. See parameter <b>14.12 DIO1 ON delay</b> .	0.0 s
	0.0 ... 3000.0 s	Deactivation delay for DIO1.	10 = 1 s

## 110 Parameters

No.	Name/Value	Description	Def/FbEq16
14.14	<i>DIO2 configuration</i>	Selects whether DIO2 of the extension module is used as a digital input or output.	<i>Input</i>
	Input	DIO2 is used as a digital input.	0
	Output	DIO2 is used as a digital output.	1
14.15	<i>DIO2 filter gain</i>	(Visible when 14.01 Module 1 type = FIO-11) Determines a filtering time for DIO2 when it is used as an input.	7.5 us
	7.5 us	7.5 microseconds.	0
	195 us	195 microseconds.	1
	780 us	780 microseconds.	2
	4.680 ms	4.680 milliseconds.	3
14.16	<i>DIO2 output source</i>	Selects a drive signal to be connected to digital input/output DIO2 when parameter 14.14 <i>DIO2 configuration</i> is set to <i>Output</i> . For the available selections, see parameter 14.11 <i>DIO1 output source</i> .	<i>Not energized</i>
14.17	<i>DIO2 ON delay</i>	Defines the activation delay for digital input/output DIO2.	0.0 s
<p>*DIO status</p> <p>**Delayed DIO status</p> <p>Time</p> <p><math>t_{On}</math>   <math>t_{Off}</math>   <math>t_{On}</math>   <math>t_{Off}</math></p> <p><math>t_{On}</math> = 14.17 <i>DIO2 ON delay</i>  <math>t_{Off}</math> = 14.18 <i>DIO2 OFF delay</i>  *Electrical status of DIO (in input mode) or status of selected source (in output mode). Indicated by 14.05 <i>DIO status</i>.  **Indicated by 14.06 <i>DIO delayed status</i>.</p>			
	0.0 ... 3000.0 s	Activation delay for DIO2.	10 = 1 s
14.18	<i>DIO2 OFF delay</i>	Defines the deactivation delay for digital input/output DIO2. See parameter 14.17 <i>DIO2 ON delay</i> .	0.0 s
	0.0 ... 3000.0 s	Deactivation delay for DIO2.	10 = 1 s
14.19	<i>DIO3 configuration</i>	(Visible when 14.01 Module 1 type = FIO-01) Selects whether DIO3 of the extension module is used as a digital input or output.	<i>Input</i>
	Input	DIO3 is used as a digital input.	0
	Output	DIO3 is used as a digital output.	1
14.21	<i>DIO3 output source</i>	(Visible when 14.01 Module 1 type = FIO-01) Selects a drive signal to be connected to digital input/output DIO3 when parameter 14.19 <i>DIO3 configuration</i> is set to <i>Output</i> . For the available selections, see parameter 14.11 <i>DIO1 output source</i> .	<i>Not energized</i>

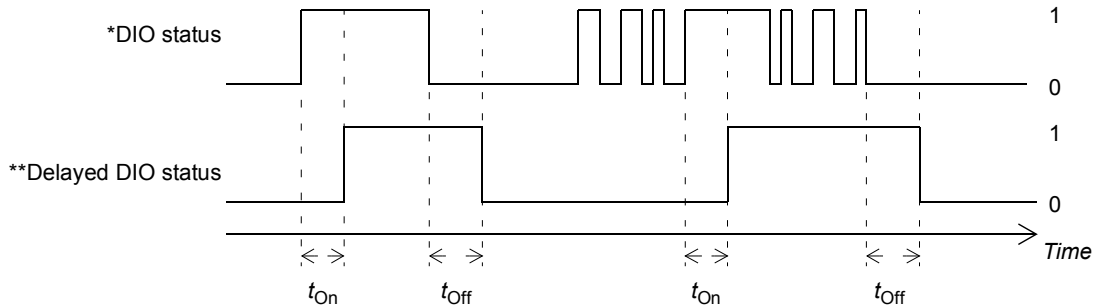
No.	Name/Value	Description	Def/FbEq16
14.21	<i>AI tune</i>	(Visible when 14.01 Module 1 type = FIO-11) Triggers the analog input tuning function, which enables the use of actual measurements as the minimum and maximum input values instead of potentially inaccurate estimates. Apply the minimum or maximum signal to the input and select the appropriate tuning function. See also the drawing at parameter 14.35 <i>AI1 scaled at AI1 min</i> .	<i>No action</i>
	No action	Tuning action completed or no action has been requested. The parameter automatically reverts to this value after any tuning action.	0
	AI1 min tune	The measured value of AI1 is set as the minimum value of AI1 into parameter 14.33 <i>AI1 min</i> .	1
	AI1 max tune	The measured value of AI1 is set as the maximum value of AI1 into parameter 14.34 <i>AI1 max</i> .	2
	AI2 min tune	The measured value of AI2 is set as the minimum value of AI2 into parameter 14.48 <i>AI2 min</i> .	3
	AI2 max tune	The measured value of AI2 is set as the maximum value of AI2 into parameter 14.49 <i>AI2 max</i> .	4
	AI3 min tune	The measured value of AI3 is set as the minimum value of AI3 into parameter 14.63 <i>AI3 min</i> .	5
	AI3 max tune	The measured value of AI3 is set as the maximum value of AI3 into parameter 14.64 <i>AI3 max</i> .	6
14.22	<i>DIO3 ON delay</i>	(Visible when 14.01 Module 1 type = FIO-01) Defines the activation delay for digital input/output DIO3.	0.0 s
	 <p><math>t_{On} = 14.22</math> <i>DIO3 ON delay</i>  <math>t_{Off} = 14.23</math> <i>DIO3 OFF delay</i>  *Electrical status of DIO (in input mode) or status of selected source (in output mode). Indicated by 14.05 <i>DIO status</i>.  **Indicated by 14.06 <i>DIO delayed status</i>.</p>		
	0.0 ... 3000.0 s	Activation delay for DIO3.	10 = 1 s

No.	Name/Value	Description	Def/FbEq16										
14.22	<i>AI force sel</i>	(Visible when 14.01 Module 1 type = FIO-11) The true readings of the analog inputs can be overridden for eg. testing purposes. A forced value parameter is provided for each analog input, and its value is applied whenever the corresponding bit in this parameter is 1.	00000000h										
<table border="1"> <thead> <tr> <th>Bit</th> <th>Value</th> </tr> </thead> <tbody> <tr> <td>0</td> <td>1 = Force AI1 to value of parameter <a href="#">14.28 AI1 force data</a>.</td> </tr> <tr> <td>1</td> <td>1 = Force AI2 to value of parameter <a href="#">14.43 AI2 force data</a>.</td> </tr> <tr> <td>2</td> <td>1 = Force AI3 to value of parameter <a href="#">14.58 AI3 force data</a>.</td> </tr> <tr> <td>3...31</td> <td>Reserved.</td> </tr> </tbody> </table>				Bit	Value	0	1 = Force AI1 to value of parameter <a href="#">14.28 AI1 force data</a> .	1	1 = Force AI2 to value of parameter <a href="#">14.43 AI2 force data</a> .	2	1 = Force AI3 to value of parameter <a href="#">14.58 AI3 force data</a> .	3...31	Reserved.
Bit	Value												
0	1 = Force AI1 to value of parameter <a href="#">14.28 AI1 force data</a> .												
1	1 = Force AI2 to value of parameter <a href="#">14.43 AI2 force data</a> .												
2	1 = Force AI3 to value of parameter <a href="#">14.58 AI3 force data</a> .												
3...31	Reserved.												
	00000000h ... FFFFFFFFh	Forced values selector for analog inputs.	1 = 1										
14.23	<i>DIO3 OFF delay</i>	(Visible when 14.01 Module 1 type = FIO-01) Defines the deactivation delay for digital input/output DIO3. See parameter <a href="#">14.22 DIO3 ON delay</a> .	0.0 s										
	0.0 ... 3000.0 s	Deactivation delay for DIO3.	10 = 1 s										
14.24	<i>DIO4 configuration</i>	(Visible when 14.01 Module 1 type = FIO-01) Selects whether DIO4 of the extension module is used as a digital input or output.	<i>Input</i>										
	Input	DIO4 is used as a digital input.	0										
	Output	DIO4 is used as a digital output.	1										
14.26	<i>DIO4 output source</i>	(Visible when 14.01 Module 1 type = FIO-01) Selects a drive signal to be connected to digital input/output DIO4 when parameter <a href="#">14.24 DIO4 configuration</a> is set to <i>Output</i> . For the available selections, see parameter <a href="#">14.11 DIO1 output source</a> .	<i>Not energized</i>										
14.26	<i>AI1 actual value</i>	(Visible when 14.01 Module 1 type = FIO-11) Displays the value of analog input AI1 in mA or V (depending on whether the input is set to current or voltage). This parameter is read-only.	-										
	-22.000 ... 22.000 mA or V	Value of analog input AI1.	1000 = 1 mA or V										
14.27	<i>DIO4 ON delay</i>	(Visible when 14.01 Module 1 type = FIO-01) Defines the activation delay for digital input/output DIO4.	0.0 s										
<p>The diagram shows two digital signals over time. The top signal, labeled '*DIO status', transitions from 0 to 1, then back to 0, then has a series of pulses, then back to 0, and finally back to 1. The bottom signal, labeled '**Delayed DIO status', follows the same pattern but with a time delay. Vertical dashed lines indicate the transition points. Below the x-axis, double-headed arrows indicate the delay times: <math>t_{On}</math> for the rising edges and <math>t_{Off}</math> for the falling edges.</p>													
$t_{On}$ = <a href="#">14.27 DIO4 ON delay</a> $t_{Off}$ = <a href="#">14.28 DIO4 OFF delay</a> *Electrical status of DIO (in input mode) or status of selected source (in output mode). Indicated by <a href="#">14.05 DIO status</a> . **Indicated by <a href="#">14.06 DIO delayed status</a> .													

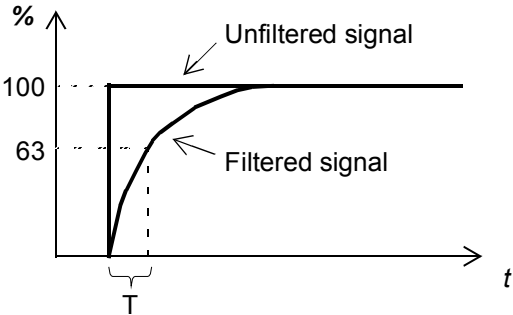

No.	Name/Value	Description	Def/FbEq16
	0.0 ... 3000.0 s	Activation delay for DIO4.	10 = 1 s
14.27	<i>AI1 scaled value</i>	(Visible when 14.01 Module 1 type = FIO-11) Displays the value of analog input AI1 after scaling. See parameter 14.35 AI1 scaled at AI1 min. This parameter is read-only.	-
	-32768.000 ... 32767.000	Scaled value of analog input AI1.	1 = 1
14.28	<i>DIO4 OFF delay</i>	(Visible when 14.01 Module 1 type = FIO-01) Defines the deactivation delay for digital input/output DIO4. See parameter 14.27 DIO4 ON delay.	0.0 s
	0.0 ... 3000.0 s	Deactivation delay for DIO4.	10 = 1 s
14.28	<i>AI1 force data</i>	(Visible when 14.01 Module 1 type = FIO-11) Forced value that can be used instead of the true reading of the input. See parameter 14.22 AI force sel.	
	-22.000 ... 22.000 mA or V	Forced value of analog input AI1.	1000 = 1 mA or V
14.29	<i>AI1 HW switch pos</i>	(Visible when 14.01 Module 1 type = FIO-11) Shows the position of the hardware current/voltage selector on the I/O extension module. <b>Note:</b> The setting of the current/voltage selector must match the unit selection made in parameter 14.30 AI1 unit selection. I/O module reboot either by cycling the power or through parameter 96.08 Control board boot is required to validate any changes in the jumper settings.	-
	V	Volts.	2
	mA	Milliamperes.	10
14.30	<i>AI1 unit selection</i>	(Visible when 14.01 Module 1 type = FIO-11) Selects the unit for readings and settings related to analog input AI1. <b>Note:</b> This setting must match the corresponding hardware setting on the I/O extension module (see the manual of the I/O extension module). The hardware setting is shown by parameter 14.29 AI1 HW switch pos. I/O module reboot either by cycling the power or through parameter 96.08 Control board boot is required to validate any changes in the jumper settings.	<i>mA</i>
	V	Volts.	2
	mA	Milliamperes.	10
14.31	<i>RO status</i>	(Visible when 14.01 Module 1 type = FIO-01) Status of relay outputs on the I/O extension module. <b>Example:</b> 00000001b = RO1 is energized, RO2 is de-energized.	-
	0000h...FFFFh	Status of relay outputs.	1 = 1
14.31	<i>AI1 filter gain</i>	(Visible when 14.01 Module 1 type = FIO-11) Selects a hardware filtering time for AI1. See also parameter 14.32 AI1 filter time.	<i>No filtering</i>
	No filtering	No filtering.	0
	125 us	125 microseconds.	1
	250 us	250 microseconds.	2
	500 us	500 microseconds.	3

No.	Name/Value	Description	Def/FbEq16
	1 ms	1 millisecond.	4
	2 ms	2 milliseconds.	5
	4 ms	4 milliseconds.	6
	7.9375 ms	7.9375 milliseconds.	7
14.32	<i>AI1 filter time</i>	<p>(Visible when <i>14.01 Module 1 type = FIO-11</i>)                      Defines the filter time constant for analog input AI1.</p>  $O = I \times (1 - e^{-t/T})$ <p>I = filter input (step)                      O = filter output                      t = time                      T = filter time constant</p> <p><b>Note:</b> The signal is also filtered due to the signal interface hardware. See parameter <i>14.31 AI1 filter gain</i>.</p>	0.040 s
	0.000 ... 30.000 s	Filter time constant.	1000 = 1 s
14.33	<i>AI1 min</i>	<p>(Visible when <i>14.01 Module 1 type = FIO-11</i>)                      Defines the minimum value for analog input AI1.                      See also parameter <i>14.21 AI tune</i>.</p>	0.000 mA or V
	-22.000 ... 22.000 mA or V	Minimum value of AI1.	1000 = 1 mA or V
14.34	<i>RO1 source</i>	<p>(Visible when <i>14.01 Module 1 type = FIO-01</i>)                      Selects a drive signal to be connected to relay output RO1.                      For the available selections, see parameter <i>14.11 DIO1 output source</i>.</p>	<i>Not energized</i>
14.34	<i>AI1 max</i>	<p>(Visible when <i>14.01 Module 1 type = FIO-11</i>)                      Defines the maximum value for analog input AI1.                      See also parameter <i>14.21 AI tune</i>.</p>	10.000 mA or V
	-22.000 ... 22.000 mA or V	Maximum value of AI1.	1000 = 1 mA or V

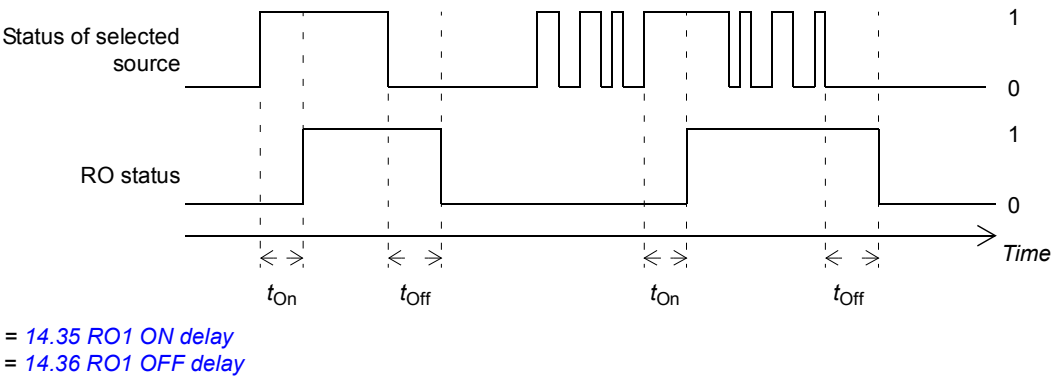
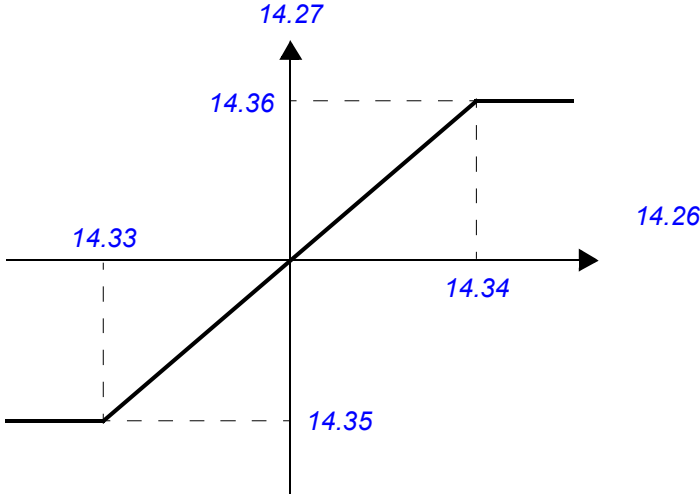
No.	Name/Value	Description	Def/FbEq16
14.35	RO1 ON delay	(Visible when 14.01 Module 1 type = FIO-01) Defines the activation delay for relay output RO1.	0.0 s
 <p><math>t_{On} = 14.35</math> RO1 ON delay <math>t_{Off} = 14.36</math> RO1 OFF delay</p>			
0.0 ... 3000.0 s		Activation delay for RO1.	10 = 1 s
14.35	AI1 scaled at AI1 min	(Visible when 14.01 Module 1 type = FIO-11) Defines the real value that corresponds to the minimum analog input AI1 value defined by parameter 14.33 AI1 min.	0.000
			
-32768.000 ... 32767.000		Real value corresponding to minimum AI1 value.	1 = 1
14.36	RO1 OFF delay	(Visible when 14.01 Module 1 type = FIO-01) Defines the deactivation delay for relay output RO1. See parameter 14.35 RO1 ON delay.	0.0 s
0.0 ... 3000.0 s		Deactivation delay for RO1.	10 = 1 s
14.36	AI1 scaled at AI1 max	(Visible when 14.01 Module 1 type = FIO-11) Defines the real value that corresponds to the maximum analog input AI1 value defined by parameter 14.34 AI1 max. See the drawing at parameter 14.35 AI1 scaled at AI1 min.	1500.0
-32768.000 ... 32767.000		Real value corresponding to maximum AI1 value.	1 = 1
14.37	RO2 source	(Visible when 14.01 Module 1 type = FIO-01) Selects a drive signal to be connected to relay output RO2. For the available selections, see parameter 14.11 DIO1 output source.	Not energized

No.	Name/Value	Description	Def/FbEq16
14.38	RO2 ON delay	(Visible when 14.01 Module 1 type = FIO-01) Defines the activation delay for relay output RO2.	0.0 s
<p> <math>t_{On} = 14.38</math> RO2 ON delay  <math>t_{Off} = 14.39</math> RO2 OFF delay         </p>			
	0.0 ... 3000.0 s	Activation delay for RO2.	10 = 1 s
14.39	RO2 OFF delay	(Visible when 14.01 Module 1 type = FIO-01) Defines the deactivation delay for relay output RO1. See parameter 14.35 RO1 ON delay.	0.0 s
	0.0 ... 3000.0 s	Deactivation delay for RO2.	10 = 1 s
14.41	AI2 actual value	(Visible when 14.01 Module 1 type = FIO-11) Displays the value of analog input AI2 in mA or V (depending on whether the input is set to current or voltage). This parameter is read-only.	-
	-22.000 ... 22.000 mA or V	Value of analog input AI2.	1000 = 1 mA or V
14.42	AI2 scaled value	(Visible when 14.01 Module 1 type = FIO-11) Displays the value of analog input AI2 after scaling. See parameter 14.50 AI2 scaled at AI2 min. This parameter is read-only.	-
	-32768.000 ... 32767.000	Scaled value of analog input AI2.	1 = 1
14.43	AI2 force data	(Visible when 14.01 Module 1 type = FIO-11) Forced value that can be used instead of the true reading of the input. See parameter 14.22 AI force sel.	0.000 mA
	-22.000 ... 22.000 mA or V	Forced value of analog input AI2.	1000 = 1 mA or V
14.44	AI2 HW switch pos	(Visible when 14.01 Module 1 type = FIO-11) Shows the position of the hardware current/voltage selector on the I/O extension module. <b>Note:</b> The setting of the current/voltage selector must match the unit selection made in parameter 14.45 AI2 unit selection. I/O module reboot either by cycling the power or through parameter 96.08 Control board boot is required to validate any changes in the jumper settings.	-
	V	Volts.	2
	mA	Milliamperes.	10

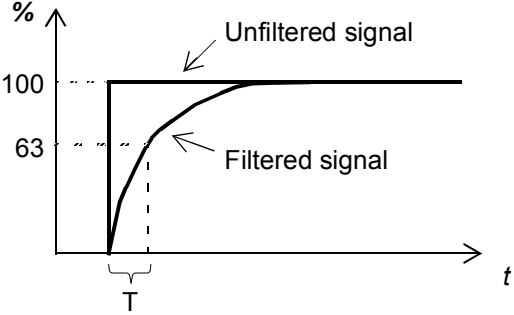
No.	Name/Value	Description	Def/FbEq16
14.45	<i>AI2 unit selection</i>	(Visible when <i>14.01 Module 1 type = FIO-11</i> ) Selects the unit for readings and settings related to analog input AI2. <b>Note:</b> This setting must match the corresponding hardware setting on the I/O extension module (see the manual of the I/O extension module). The hardware setting is shown by parameter <i>14.44 AI2 HW switch pos</i> . I/O module reboot either by cycling the power or through parameter <i>96.08 Control board boot</i> is required to validate any changes in the jumper settings.	<i>mA</i>
	V	Volts.	2
	mA	Milliamperes.	10
14.46	<i>AI2 filter gain</i>	(Visible when <i>14.01 Module 1 type = FIO-11</i> ) Selects a hardware filtering time for AI2. See also parameter <i>14.47 AI2 filter time</i> .	<i>No filtering</i>
	No filtering	No filtering.	0
	125 us	125 microseconds.	1
	250 us	250 microseconds.	2
	500 us	500 microseconds.	3
	1 ms	1 millisecond.	4
	2 ms	2 milliseconds.	5
	4 ms	4 milliseconds.	6
	7.9375 ms	7.9375 milliseconds.	7
14.47	<i>AI2 filter time</i>	(Visible when <i>14.01 Module 1 type = FIO-11</i> ) Defines the filter time constant for analog input AI2.   $O = I \times (1 - e^{-t/T})$ <p>I = filter input (step) O = filter output t = time T = filter time constant</p> <b>Note:</b> The signal is also filtered due to the signal interface hardware. See parameter <i>14.46 AI2 filter gain</i> .	0.100 s
	0.000 ... 30.000 s	Filter time constant.	1000 = 1 s

## 118 Parameters

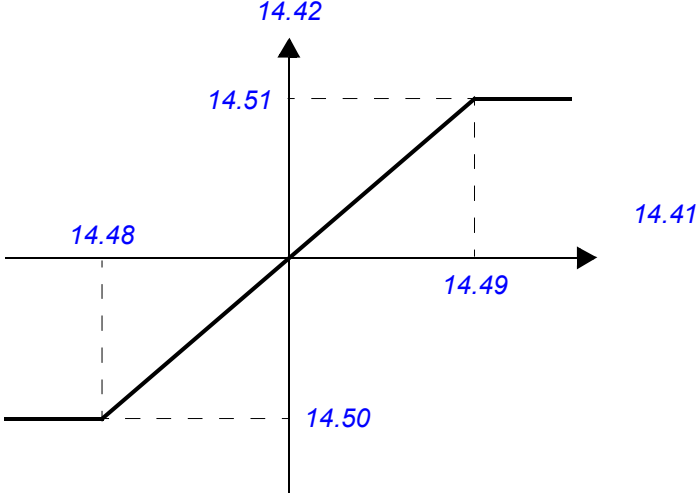
No.	Name/Value	Description	Def/FbEq16
14.48	<i>AI2 min</i>	(Visible when 14.01 Module 1 type = FIO-11) Defines the minimum value for analog input AI2. See also parameter 14.21 AI tune.	0.000 mA or V
	-22.000 ... 22.000 mA or V	Minimum value of AI2.	1000 = 1 mA or V
14.49	<i>AI2 max</i>	(Visible when 14.01 Module 1 type = FIO-11) Defines the maximum value for analog input AI2. See also parameter 14.21 AI tune.	10.000 mA or V
	-22.000 ... 22.000 mA or V	Maximum value of AI2.	1000 = 1 mA or V
14.50	<i>AI2 scaled at AI2 min</i>	(Visible when 14.01 Module 1 type = FIO-11) Defines the real value that corresponds to the minimum analog input AI2 value defined by parameter 14.48 AI2 min. 	0.000
	-32768.000 ... 32767.000	Real value corresponding to minimum AI2 value.	1 = 1
14.51	<i>AI2 scaled at AI2 max</i>	(Visible when 14.01 Module 1 type = FIO-11) Defines the real value that corresponds to the maximum analog input AI2 value defined by parameter 14.49 AI2 max. See the drawing at parameter 14.50 AI2 scaled at AI2 min.	1500.0
	-32768.000 ... 32767.000	Real value corresponding to maximum AI2 value.	1 = 1
14.56	<i>AI3 actual value</i>	(Visible when 14.01 Module 1 type = FIO-11) Displays the value of analog input AI3 in mA or V (depending on whether the input is set to current or voltage). This parameter is read-only.	-
	-22.000 ... 22.000 mA or V	Value of analog input AI3.	1000 = 1 mA or V
14.57	<i>AI3 scaled value</i>	(Visible when 14.01 Module 1 type = FIO-11) Displays the value of analog input AI3 after scaling. See parameter 14.65 AI3 scaled at AI3 min. This parameter is read-only.	-
	-32768.000 ... 32767.000	Scaled value of analog input AI3.	1 = 1

No.	Name/Value	Description	Def/FbEq16
14.58	<i>AI3 force data</i>	(Visible when 14.01 Module 1 type = FIO-11) Forced value that can be used instead of the true reading of the input. See parameter 14.22 <i>AI force sel.</i>	0.000 mA
	-22.000 ... 22.000 mA or V	Forced value of analog input AI3.	1000 = 1 mA or V
14.59	<i>AI3 HW switch pos</i>	(Visible when 14.01 Module 1 type = FIO-11) Shows the position of the hardware current/voltage selector on the I/O extension module. <b>Note:</b> The setting of the current/voltage selector must match the unit selection made in parameter 14.60 <i>AI3 unit selection</i> . I/O module reboot either by cycling the power or through parameter 96.08 <i>Control board boot</i> is required to validate any changes in the jumper settings.	-
	V	Volts.	2
	mA	Milliamperes.	10
14.60	<i>AI3 unit selection</i>	(Visible when 14.01 Module 1 type = FIO-11) Selects the unit for readings and settings related to analog input AI3. <b>Note:</b> This setting must match the corresponding hardware setting on the I/O extension module (see the manual of the I/O extension module). The hardware setting is shown by parameter 14.59 <i>AI3 HW switch pos</i> . I/O module reboot either by cycling the power or through parameter 96.08 <i>Control board boot</i> is required to validate any changes in the jumper settings.	<i>mA</i>
	V	Volts.	2
	mA	Milliamperes.	10
14.61	<i>AI3 filter gain</i>	(Visible when 14.01 Module 1 type = FIO-11) Selects a hardware filtering time for AI3. See also parameter 14.62 <i>AI3 filter time</i> .	<i>No filtering</i>
	No filtering	No filtering.	0
	125 us	125 microseconds.	1
	250 us	250 microseconds.	2
	500 us	500 microseconds.	3
	1 ms	1 millisecond.	4
	2 ms	2 milliseconds.	5
	4 ms	4 milliseconds.	6
	7.9375 ms	7.9375 milliseconds.	7

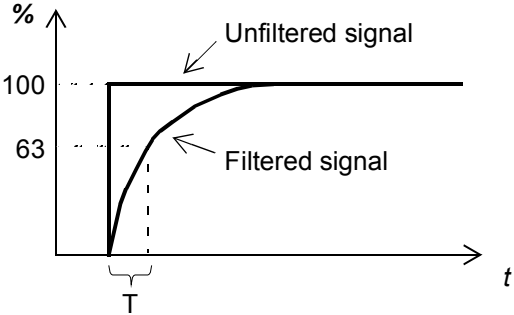
No.	Name/Value	Description	Def/FbEq16
14.62	<a href="#">AI3 filter time</a>	<p>(Visible when <a href="#">14.01 Module 1 type = FIO-11</a>)                      Defines the filter time constant for analog input AI3.</p>  <p><math>O = I \times (1 - e^{-t/T})</math></p> <p>I = filter input (step)                      O = filter output                      t = time                      T = filter time constant</p> <p><b>Note:</b> The signal is also filtered due to the signal interface hardware. See parameter <a href="#">14.61 AI3 filter gain</a>.</p>	0.100 s
	0.000 ... 30.000 s	Filter time constant.	1000 = 1 s
14.63	<a href="#">AI3 min</a>	<p>(Visible when <a href="#">14.01 Module 1 type = FIO-11</a>)                      Defines the minimum value for analog input AI3.                      See also parameter <a href="#">14.21 AI tune</a>.</p>	0.000 mA or V
	-22.000 ... 22.000 mA or V	Minimum value of AI3.	1000 = 1 mA or V
14.64	<a href="#">AI3 max</a>	<p>(Visible when <a href="#">14.01 Module 1 type = FIO-11</a>)                      Defines the maximum value for analog input AI3.                      See also parameter <a href="#">14.21 AI tune</a>.</p>	10.000 mA or V
	-22.000 ... 22.000 mA or V	Maximum value of AI3.	1000 = 1 mA or V

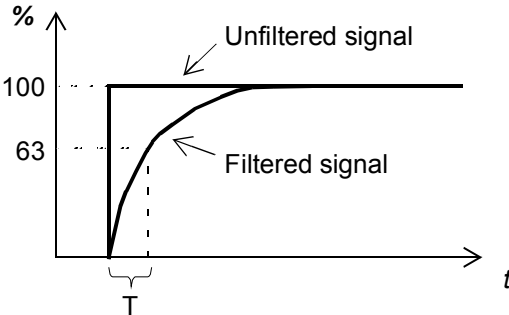

No.	Name/Value	Description	Def/FbEq16						
14.65	<i>AI3 scaled at AI3 min</i>	(Visible when 14.01 Module 1 type = FIO-11) Defines the real value that corresponds to the minimum analog input AI3 value defined by parameter 14.63 <i>AI3 min</i> .	0.000						
	-32768.000 ... 32767.000	Real value corresponding to minimum AI3 value.	1 = 1						
14.66	<i>AI3 scaled at AI3 max</i>	(Visible when 14.01 Module 1 type = FIO-11) Defines the real value that corresponds to the maximum analog input AI3 value defined by parameter 14.64 <i>AI3 max</i> . See the drawing at parameter 14.65 <i>AI3 scaled at AI3 min</i> .	1500.0						
	-32768.000 ... 32767.000	Real value corresponding to maximum AI3 value.	1 = 1						
14.71	<i>AO force selection</i>	(Visible when 14.01 Module 1 type = FIO-11) The value of the analog output can be overridden for eg. testing purposes. A forced value parameter (14.78 <i>AO1 force data</i> ) is provided for the analog output, and its value is applied whenever the corresponding bit in this parameter is 1.	00000000h						
<table border="1"> <thead> <tr> <th>Bit</th> <th>Value</th> </tr> </thead> <tbody> <tr> <td>0</td> <td>1 = Force AO1 to value of parameter 14.78 <i>AO1 force data</i>.</td> </tr> <tr> <td>1...31</td> <td>Reserved.</td> </tr> </tbody> </table>				Bit	Value	0	1 = Force AO1 to value of parameter 14.78 <i>AO1 force data</i> .	1...31	Reserved.
Bit	Value								
0	1 = Force AO1 to value of parameter 14.78 <i>AO1 force data</i> .								
1...31	Reserved.								
	00000000h ... FFFFFFFFh	Forced values selector for analog outputs.	1 = 1						
14.76	<i>AO1 actual value</i>	(Visible when 14.01 Module 1 type = FIO-11) Displays the value of AO1 in mA. This parameter is read-only.	-						
	0.000 ... 22.000 mA	Value of AO1.	1000 = 1 mA						
14.77	<i>AO1 source</i>	(Visible when 14.01 Module 1 type = FIO-11) Selects a signal to be connected to analog output AO1. Alternatively, sets the output to excitation mode to feed a constant current to a temperature sensor.	<i>Zero</i>						
	Zero	None.	0						
	Motor speed used	01.01 <i>Motor speed used</i> (page 84).	1						
	Output frequency	01.06 <i>Output frequency</i> (page 84).	3						
	Motor current	01.07 <i>Motor current</i> (page 84).	4						

No.	Name/Value	Description	Def/FbEq16
	Motor torque	<a href="#">01.10 Motor torque %</a> (page 84).	6
	DC voltage	<a href="#">01.11 DC voltage</a> (page 84).	7
	Power inu out	<a href="#">01.14 Output power</a> (page 84).	8
	Speed ref ramp in	<a href="#">23.01 Speed ref ramp in</a> (page 151).	10
	Speed ref ramp out	<a href="#">23.02 Speed ref ramp out</a> (page 151).	11
	Speed ref used	<a href="#">24.01 Used speed reference</a> (page 155).	12
	Torq ref used	<a href="#">26.02 Torque ref used</a> (page 164).	13
	Freq ref used	<a href="#">28.02 Frequency ref ramp out</a> (page 168).	14
	Process PID out	<a href="#">40.01 Process PID actual value</a> (page 203).	16
	Process PID fbk	<a href="#">40.02 Feedback actual value</a> (page 203).	17
	Process PID act	<a href="#">40.03 Setpoint actual value</a> (page 203).	18
	Process PID dev	<a href="#">40.04 Deviation actual value</a> (page 203).	19
	Force PT100 excitation	The output is used to feed an excitation current to 1...3 Pt100 sensors. See section <a href="#">Motor thermal protection</a> (page 56).	20
	Force KTY84 excitation	The output is used to feed an excitation current to a KTY84 sensor. See section <a href="#">Motor thermal protection</a> (page 56).	21
	Other	The value is taken from another parameter.	-
<a href="#">14.78</a>	<a href="#">AO1 force data</a>	(Visible when <a href="#">14.01 Module 1 type = FIO-11</a> ) Forced value that can be used instead of the selected output signal. See parameter <a href="#">14.71 AO force selection</a> .	0.000 mA
	0.000 ... 22.000 mA	Forced value of analog output AI1.	1000 = 1 mA
<a href="#">14.79</a>	<a href="#">AO1 filter time</a>	(Visible when <a href="#">14.01 Module 1 type = FIO-11</a> ) Defines the filtering time constant for analog output AO1.  $O = I \times (1 - e^{-t/T})$ I = filter input (step) O = filter output t = time T = filter time constant	0.100 s
	0.000 ... 30.000 s	Filter time constant.	1000 = 1 s

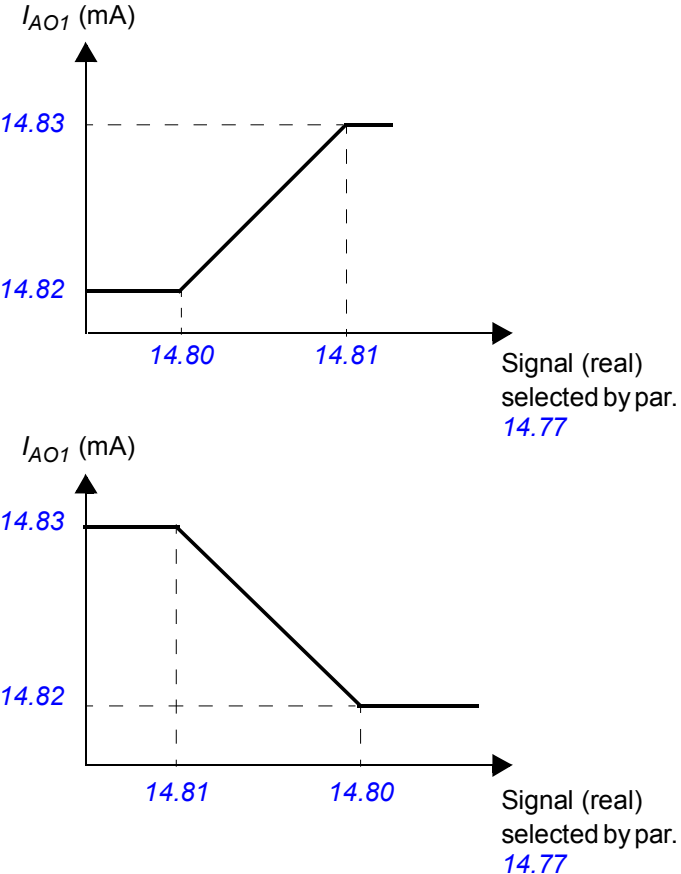
No.	Name/Value	Description	Def/FbEq16
14.80	<i>AO1 source min</i>	<p>(Visible when 14.01 Module 1 type = FIO-11)</p> <p>Defines the real value of the signal (selected by parameter 14.77 <i>AO1 source</i>) that corresponds to the minimum AO1 output value (defined by parameter 14.82 <i>AO1 out at AO1 src min</i>).</p>  <p>The figure contains two graphs. Both graphs have <math>I_{AO1}</math> (mA) on the vertical axis and 'Signal (real) selected by par. 14.77' on the horizontal axis. The top graph shows a signal value increasing from 14.80 to 14.81. The corresponding <math>I_{AO1}</math> value starts at 14.82 mA for a signal of 14.80, increases linearly to 14.83 mA at a signal of 14.81, and then remains constant at 14.83 mA for higher signal values. The bottom graph shows a signal value increasing from 14.81 to 14.80. The corresponding <math>I_{AO1}</math> value starts at 14.83 mA for a signal of 14.81, decreases linearly to 14.82 mA at a signal of 14.80, and then remains constant at 14.82 mA for higher signal values.</p>	0.0
-32768.0 ... 32767.0	Real signal value corresponding to minimum AO1 output value.	1 = 1	
14.81	<i>AO1 source max</i>	<p>(Visible when 14.01 Module 1 type = FIO-11)</p> <p>Defines the real value of the signal (selected by parameter 14.77 <i>AO1 source</i>) that corresponds to the maximum AO1 output value (defined by parameter 14.83 <i>AO1 out at AO1 src max</i>). See parameter 14.80 <i>AO1 source min</i>.</p>	1500.0
-32768.0 ... 32767.0	Real signal value corresponding to maximum AO1 output value.	1 = 1	
14.82	<i>AO1 out at AO1 src min</i>	<p>(Visible when 14.01 Module 1 type = FIO-11)</p> <p>Defines the minimum output value for analog output AO1. See also drawing at parameter 14.80 <i>AO1 source min</i>.</p>	0.000 mA
0.000 ... 22.000 mA	Minimum AO1 output value.	1000 = 1 mA	
14.83	<i>AO1 out at AO1 src max</i>	<p>(Visible when 14.01 Module 1 type = FIO-11)</p> <p>Defines the maximum output value for analog output AO1. See also drawing at parameter 14.80 <i>AO1 source min</i>.</p>	20.000 mA
0.000 ... 22.000 mA	Maximum AO1 output value.	1000 = 1 mA	

No.	Name/Value	Description	Def/FbEq16
<b>15 I/O extension module 2</b>		Configuration of I/O extension module 2. See also section <i>Programmable I/O extensions</i> (page 27). <b>Note:</b> The contents of the parameter group vary according to the selected I/O extension module type.	
15.01	<i>Module 2 type</i>	See parameter <i>14.01 Module 1 type</i> .	<i>None</i>
15.02	<i>Module 2 location</i>	See parameter <i>14.02 Module 1 location</i> .	1 (Slot 1)
15.03	<i>Module 2 status</i>	See parameter <i>14.03 Module 1 status</i> .	<i>No option</i>
15.05	<i>DIO status</i>	See parameter <i>14.05 DIO status</i> .	-
15.06	<i>DIO delayed status</i>	See parameter <i>14.06 DIO delayed status</i> .	-
15.09	<i>DIO1 configuration</i>	See parameter <i>14.09 DIO1 configuration</i> .	<i>Input</i>
15.10	<i>DIO1 filter gain</i>	(Visible when <i>15.01 Module 2 type = FIO-11</i> ) See parameter <i>14.10 DIO1 filter gain</i> .	<i>7.5 us</i>
15.11	<i>DIO1 output source</i>	See parameter <i>14.11 DIO1 output source</i> .	<i>Not energized</i>
15.12	<i>DIO1 ON delay</i>	See parameter <i>14.12 DIO1 ON delay</i> .	0.0 s
15.13	<i>DIO1 OFF delay</i>	See parameter <i>14.13 DIO1 OFF delay</i> .	0.0 s
15.14	<i>DIO2 configuration</i>	See parameter <i>14.14 DIO2 configuration</i> .	<i>Input</i>
15.15	<i>DIO2 filter gain</i>	(Visible when <i>15.01 Module 2 type = FIO-11</i> ) See parameter <i>14.15 DIO2 filter gain</i> .	<i>7.5 us</i>
15.16	<i>DIO2 output source</i>	See parameter <i>14.16 DIO2 output source</i> .	<i>Not energized</i>
15.17	<i>DIO2 ON delay</i>	See parameter <i>14.17 DIO2 ON delay</i> .	0.0 s
15.18	<i>DIO2 OFF delay</i>	See parameter <i>14.18 DIO2 OFF delay</i> .	0.0 s
15.19	<i>DIO3 configuration</i>	(Visible when <i>15.01 Module 2 type = FIO-01</i> ) See parameter <i>14.19 DIO3 configuration</i> .	<i>Input</i>
15.21	<i>DIO3 output source</i>	(Visible when <i>15.01 Module 2 type = FIO-01</i> ) See parameter <i>14.21 DIO3 output source</i> .	<i>Not energized</i>
15.21	<i>AI tune</i>	(Visible when <i>15.01 Module 2 type = FIO-11</i> ) See parameter <i>14.21 AI tune</i> .	<i>No action</i>
15.22	<i>DIO3 ON delay</i>	(Visible when <i>15.01 Module 2 type = FIO-01</i> ) See parameter <i>14.22 DIO3 ON delay</i> .	0.0 s
15.22	<i>AI force sel</i>	(Visible when <i>15.01 Module 2 type = FIO-11</i> ) See parameter <i>14.22 AI force sel</i> .	00000000h
15.23	<i>DIO3 OFF delay</i>	(Visible when <i>15.01 Module 2 type = FIO-01</i> ) See parameter <i>14.23 DIO3 OFF delay</i> .	0.0 s
15.24	<i>DIO4 configuration</i>	(Visible when <i>15.01 Module 2 type = FIO-01</i> ) See parameter <i>14.24 DIO4 configuration</i> .	<i>Input</i>
15.26	<i>DIO4 output source</i>	(Visible when <i>15.01 Module 2 type = FIO-01</i> ) See parameter <i>14.26 DIO4 output source</i> .	<i>Not energized</i>
15.26	<i>AI1 actual value</i>	(Visible when <i>15.01 Module 2 type = FIO-11</i> ) See parameter <i>14.26 AI1 actual value</i> .	-
15.27	<i>DIO4 ON delay</i>	(Visible when <i>15.01 Module 2 type = FIO-01</i> ) See parameter <i>14.27 DIO4 ON delay</i> .	0.0 s
15.27	<i>AI1 scaled value</i>	(Visible when <i>15.01 Module 2 type = FIO-11</i> ) See parameter <i>14.27 AI1 scaled value</i> .	-

No.	Name/Value	Description	Def/FbEq16
15.28	<i>DIO4 OFF delay</i>	(Visible when 15.01 Module 2 type = FIO-01) See parameter 14.28 DIO4 OFF delay.	0.0 s
15.28	<i>AI1 force data</i>	(Visible when 15.01 Module 2 type = FIO-11) See parameter 14.28 AI1 force data.	
15.29	<i>AI1 HW switch pos</i>	(Visible when 15.01 Module 2 type = FIO-11) See parameter 14.29 AI1 HW switch pos.	-
15.30	<i>AI1 unit selection</i>	(Visible when 15.01 Module 2 type = FIO-11) See parameter 14.30 AI1 unit selection.	mA
15.31	<i>RO status</i>	(Visible when 15.01 Module 2 type = FIO-01) See parameter 14.31 RO status.	-
15.31	<i>AI1 filter gain</i>	(Visible when 15.01 Module 2 type = FIO-11) See parameter 14.31 AI1 filter gain.	No filtering
15.32	<i>AI1 filter time</i>	(Visible when 15.01 Module 2 type = FIO-11) See parameter 14.32 AI1 filter time.	0.040 s
15.33	<i>AI1 min</i>	(Visible when 15.01 Module 2 type = FIO-11) See parameter 14.33 AI1 min.	0.000 mA or V
15.34	<i>RO1 source</i>	(Visible when 15.01 Module 2 type = FIO-01) See parameter 14.34 RO1 source.	Not energized
15.34	<i>AI1 max</i>	(Visible when 15.01 Module 2 type = FIO-11) See parameter 14.34 AI1 max.	10.000 mA or V
15.35	<i>RO1 ON delay</i>	(Visible when 15.01 Module 2 type = FIO-01) See parameter 14.35 RO1 ON delay.	0.0 s
15.35	<i>AI1 scaled at AI1 min</i>	(Visible when 15.01 Module 2 type = FIO-11) See parameter 14.35 AI1 scaled at AI1 min.	0.000
15.36	<i>RO1 OFF delay</i>	(Visible when 15.01 Module 2 type = FIO-01) See parameter 14.36 RO1 OFF delay.	0.0 s
15.36	<i>AI1 scaled at AI1 max</i>	(Visible when 15.01 Module 2 type = FIO-11) See parameter 14.36 AI1 scaled at AI1 max.	1500.0
15.37	<i>RO2 source</i>	(Visible when 15.01 Module 2 type = FIO-01) See parameter 14.37 RO2 source.	Not energized
15.38	<i>RO2 ON delay</i>	(Visible when 15.01 Module 2 type = FIO-01) See parameter 14.38 RO2 ON delay.	0.0 s
15.39	<i>RO2 OFF delay</i>	(Visible when 15.01 Module 2 type = FIO-01) See parameter 14.39 RO2 OFF delay.	0.0 s
15.41	<i>AI2 actual value</i>	(Visible when 15.01 Module 2 type = FIO-11) See parameter 14.41 AI2 actual value.	-
15.42	<i>AI2 scaled value</i>	(Visible when 15.01 Module 2 type = FIO-11) See parameter 14.42 AI2 scaled value.	-
15.43	<i>AI2 force data</i>	(Visible when 15.01 Module 2 type = FIO-11) See parameter 14.43 AI2 force data.	0.000 mA
15.44	<i>AI2 HW switch pos</i>	(Visible when 15.01 Module 2 type = FIO-11) See parameter 14.44 AI2 HW switch pos.	-
15.45	<i>AI2 unit selection</i>	(Visible when 15.01 Module 2 type = FIO-11) See parameter 14.45 AI2 unit selection.	mA
15.46	<i>AI2 filter gain</i>	(Visible when 15.01 Module 2 type = FIO-11) See parameter 14.46 AI2 filter gain.	No filtering

## 126 Parameters

No.	Name/Value	Description	Def/FbEq16
15.47	<i>AI2 filter time</i>	(Visible when 15.01 Module 2 type = FIO-11) See parameter 14.47 <i>AI2 filter time</i> .	0.100 s
15.48	<i>AI2 min</i>	(Visible when 15.01 Module 2 type = FIO-11) See parameter 14.48 <i>AI2 min</i> .	0.000 mA or V
15.49	<i>AI2 max</i>	(Visible when 15.01 Module 2 type = FIO-11) See parameter 14.49 <i>AI2 max</i> .	10.000 mA or V
15.50	<i>AI2 scaled at AI2 min</i>	(Visible when 15.01 Module 2 type = FIO-11) See parameter 14.50 <i>AI2 scaled at AI2 min</i> .	0.000
15.51	<i>AI2 scaled at AI2 max</i>	(Visible when 15.01 Module 2 type = FIO-11) See parameter 14.51 <i>AI2 scaled at AI2 max</i> .	1500.0
15.56	<i>AI3 actual value</i>	(Visible when 15.01 Module 2 type = FIO-11) See parameter 14.56 <i>AI3 actual value</i> .	-
15.57	<i>AI3 scaled value</i>	(Visible when 15.01 Module 2 type = FIO-11) See parameter 14.57 <i>AI3 scaled value</i> .	-
15.58	<i>AI3 force data</i>	(Visible when 15.01 Module 2 type = FIO-11) See parameter 14.58 <i>AI3 force data</i> .	0.000 mA
15.59	<i>AI3 HW switch pos</i>	(Visible when 15.01 Module 2 type = FIO-11) See parameter 14.59 <i>AI3 HW switch pos</i> .	-
15.60	<i>AI3 unit selection</i>	(Visible when 15.01 Module 2 type = FIO-11) See parameter 14.60 <i>AI3 unit selection</i> .	<i>mA</i>
15.61	<i>AI3 filter gain</i>	(Visible when 15.01 Module 2 type = FIO-11) See parameter 14.61 <i>AI3 filter gain</i> .	<i>No filtering</i>
15.62	<i>AI3 filter time</i>	(Visible when 15.01 Module 2 type = FIO-11) See parameter 14.62 <i>AI3 filter time</i> .	0.100 s
15.63	<i>AI3 min</i>	(Visible when 15.01 Module 2 type = FIO-11) See parameter 14.63 <i>AI3 min</i> .	0.000 mA or V
15.64	<i>AI3 max</i>	(Visible when 15.01 Module 2 type = FIO-11) See parameter 14.64 <i>AI3 max</i> .	10.000 mA or V
15.65	<i>AI3 scaled at AI3 min</i>	(Visible when 15.01 Module 2 type = FIO-11) See parameter 14.65 <i>AI3 scaled at AI3 min</i> .	0.000
15.66	<i>AI3 scaled at AI3 max</i>	(Visible when 15.01 Module 2 type = FIO-11) See parameter 14.66 <i>AI3 scaled at AI3 max</i> .	1500.0
15.71	<i>AO force selection</i>	(Visible when 15.01 Module 2 type = FIO-11) See parameter 14.71 <i>AO force selection</i> .	00000000h
15.76	<i>AO1 actual value</i>	(Visible when 15.01 Module 2 type = FIO-11) See parameter 14.76 <i>AO1 actual value</i> .	-
15.77	<i>AO1 source</i>	(Visible when 15.01 Module 2 type = FIO-11) See parameter 14.77 <i>AO1 source</i> .	<i>Zero</i>
15.78	<i>AO1 force data</i>	(Visible when 15.01 Module 2 type = FIO-11) See parameter 14.78 <i>AO1 force data</i> .	0.000 mA
15.79	<i>AO1 filter time</i>	(Visible when 15.01 Module 2 type = FIO-11) See parameter 14.79 <i>AO1 filter time</i> .	0.100 s
15.80	<i>AO1 source min</i>	(Visible when 15.01 Module 2 type = FIO-11) See parameter 14.80 <i>AO1 source min</i> .	0.0
15.81	<i>AO1 source max</i>	(Visible when 15.01 Module 2 type = FIO-11) See parameter 14.81 <i>AO1 source max</i> .	1500.0

No.	Name/Value	Description	Def/FbEq16
15.82	AO1 out at AO1 src min	(Visible when 15.01 Module 2 type = FIO-11) See parameter 14.82 AO1 out at AO1 src min.	0.000 mA
15.83	AO1 out at AO1 src max	(Visible when 15.01 Module 2 type = FIO-11) See parameter 14.83 AO1 out at AO1 src max.	20.000 mA
<b>16 I/O extension module 3</b>		Configuration of I/O extension module 3. See also section <i>Programmable I/O extensions</i> (page 27). <b>Note:</b> The contents of the parameter group vary according to the selected I/O extension module type.	
16.01	Module 3 type	See parameter 14.01 Module 1 type.	None
16.02	Module 3 location	See parameter 14.02 Module 1 location.	1 (Slot 1)
16.03	Module 3 status	See parameter 14.03 Module 1 status.	No option
16.05	DIO status	See parameter 14.05 DIO status.	-
16.06	DIO delayed status	See parameter 14.06 DIO delayed status.	-
16.09	DIO1 configuration	See parameter 14.09 DIO1 configuration.	Input
16.10	DIO1 filter gain	(Visible when 15.01 Module 2 type = FIO-11) See parameter 14.10 DIO1 filter gain.	7.5 us
16.11	DIO1 output source	See parameter 14.11 DIO1 output source.	Not energized
16.12	DIO1 ON delay	See parameter 14.12 DIO1 ON delay.	0.0 s
16.13	DIO1 OFF delay	See parameter 14.13 DIO1 OFF delay.	0.0 s
16.14	DIO2 configuration	See parameter 14.14 DIO2 configuration.	Input
16.15	DIO2 filter gain	(Visible when 16.01 Module 3 type = FIO-11) See parameter 14.15 DIO2 filter gain.	7.5 us
16.16	DIO2 output source	See parameter 14.16 DIO2 output source.	Not energized
16.17	DIO2 ON delay	See parameter 14.17 DIO2 ON delay.	0.0 s
16.18	DIO2 OFF delay	See parameter 14.18 DIO2 OFF delay.	0.0 s
16.19	DIO3 configuration	(Visible when 16.01 Module 3 type = FIO-01) See parameter 14.19 DIO3 configuration.	Input
16.21	DIO3 output source	(Visible when 16.01 Module 3 type = FIO-01) See parameter 14.21 DIO3 output source.	Not energized
16.21	AI tune	(Visible when 16.01 Module 3 type = FIO-11) See parameter 14.21 AI tune.	No action
16.22	DIO3 ON delay	(Visible when 16.01 Module 3 type = FIO-01) See parameter 14.22 DIO3 ON delay.	0.0 s
16.22	AI force sel	(Visible when 16.01 Module 3 type = FIO-11) See parameter 14.22 AI force sel.	00000000h
16.23	DIO3 OFF delay	(Visible when 16.01 Module 3 type = FIO-01) See parameter 14.23 DIO3 OFF delay.	0.0 s
16.24	DIO4 configuration	(Visible when 16.01 Module 3 type = FIO-01) See parameter 14.24 DIO4 configuration.	Input
16.26	DIO4 output source	(Visible when 16.01 Module 3 type = FIO-01) See parameter 14.26 DIO4 output source.	Not energized
16.26	AI1 actual value	(Visible when 16.01 Module 3 type = FIO-11) See parameter 14.26 AI1 actual value.	-

## 128 Parameters

No.	Name/Value	Description	Def/FbEq16
16.27	<i>DIO4 ON delay</i>	(Visible when 16.01 Module 3 type = FIO-01) See parameter 14.27 DIO4 ON delay.	0.0 s
16.27	<i>AI1 scaled value</i>	(Visible when 16.01 Module 3 type = FIO-11) See parameter 14.27 AI1 scaled value.	-
16.28	<i>DIO4 OFF delay</i>	(Visible when 16.01 Module 3 type = FIO-01) See parameter 14.28 DIO4 OFF delay.	0.0 s
16.28	<i>AI1 force data</i>	(Visible when 16.01 Module 3 type = FIO-11) See parameter 14.28 AI1 force data.	
16.29	<i>AI1 HW switch pos</i>	(Visible when 16.01 Module 3 type = FIO-11) See parameter 14.29 AI1 HW switch pos.	-
16.30	<i>AI1 unit selection</i>	(Visible when 16.01 Module 3 type = FIO-11) See parameter 14.30 AI1 unit selection.	mA
16.31	<i>RO status</i>	(Visible when 16.01 Module 3 type = FIO-11) See parameter 14.31 RO status.	-
16.31	<i>AI1 filter gain</i>	(Visible when 16.01 Module 3 type = FIO-11) See parameter 14.31 AI1 filter gain.	No filtering
16.32	<i>AI1 filter time</i>	(Visible when 16.01 Module 3 type = FIO-11) See parameter 14.32 AI1 filter time.	0.040 s
16.33	<i>AI1 min</i>	(Visible when 16.01 Module 3 type = FIO-11) See parameter 14.33 AI1 min.	0.000 mA or V
16.34	<i>RO1 source</i>	(Visible when 16.01 Module 3 type = FIO-01) See parameter 14.34 RO1 source.	Not energized
16.34	<i>AI1 max</i>	(Visible when 16.01 Module 3 type = FIO-11) See parameter 14.34 AI1 max.	10.000 mA or V
16.35	<i>RO1 ON delay</i>	(Visible when 16.01 Module 3 type = FIO-01) See parameter 14.35 RO1 ON delay.	0.0 s
16.35	<i>AI1 scaled at AI1 min</i>	(Visible when 16.01 Module 3 type = FIO-11) See parameter 14.35 AI1 scaled at AI1 min.	0.000
16.36	<i>RO1 OFF delay</i>	(Visible when 16.01 Module 3 type = FIO-01) See parameter 14.36 RO1 OFF delay.	0.0 s
16.36	<i>AI1 scaled at AI1 max</i>	(Visible when 16.01 Module 3 type = FIO-11) See parameter 14.36 AI1 scaled at AI1 max.	1500.0
16.37	<i>RO2 source</i>	(Visible when 16.01 Module 3 type = FIO-01) See parameter 14.37 RO2 source.	Not energized
16.38	<i>RO2 ON delay</i>	(Visible when 16.01 Module 3 type = FIO-01) See parameter 14.38 RO2 ON delay.	0.0 s
16.39	<i>RO2 OFF delay</i>	(Visible when 16.01 Module 3 type = FIO-01) See parameter 14.39 RO2 OFF delay.	0.0 s
16.41	<i>AI2 actual value</i>	(Visible when 16.01 Module 3 type = FIO-11) See parameter 14.41 AI2 actual value.	-
16.42	<i>AI2 scaled value</i>	(Visible when 16.01 Module 3 type = FIO-11) See parameter 14.42 AI2 scaled value.	-
16.43	<i>AI2 force data</i>	(Visible when 16.01 Module 3 type = FIO-11) See parameter 14.43 AI2 force data.	0.000 mA
16.44	<i>AI2 HW switch pos</i>	(Visible when 16.01 Module 3 type = FIO-11) See parameter 14.44 AI2 HW switch pos.	-



No.	Name/Value	Description	Def/FbEq16
16.45	<i>AI2 unit selection</i>	(Visible when 16.01 Module 3 type = FIO-11) See parameter 14.45 <i>AI2 unit selection</i> .	<i>mA</i>
16.46	<i>AI2 filter gain</i>	(Visible when 16.01 Module 3 type = FIO-11) See parameter 14.46 <i>AI2 filter gain</i> .	<i>No filtering</i>
16.47	<i>AI2 filter time</i>	(Visible when 16.01 Module 3 type = FIO-11) See parameter 14.47 <i>AI2 filter time</i> .	0.100 s
16.48	<i>AI2 min</i>	(Visible when 16.01 Module 3 type = FIO-11) See parameter 14.48 <i>AI2 min</i> .	0.000 mA or V
16.49	<i>AI2 max</i>	(Visible when 16.01 Module 3 type = FIO-11) See parameter 14.49 <i>AI2 max</i> .	10.000 mA or V
16.50	<i>AI2 scaled at AI2 min</i>	(Visible when 16.01 Module 3 type = FIO-11) See parameter 14.50 <i>AI2 scaled at AI2 min</i> .	0.000
16.51	<i>AI2 scaled at AI2 max</i>	(Visible when 16.01 Module 3 type = FIO-11) See parameter 14.51 <i>AI2 scaled at AI2 max</i> .	1500.0
16.56	<i>AI3 actual value</i>	(Visible when 16.01 Module 3 type = FIO-11) See parameter 14.56 <i>AI3 actual value</i> .	-
16.57	<i>AI3 scaled value</i>	(Visible when 16.01 Module 3 type = FIO-11) See parameter 14.57 <i>AI3 scaled value</i> .	-
16.58	<i>AI3 force data</i>	(Visible when 16.01 Module 3 type = FIO-11) See parameter 14.58 <i>AI3 force data</i> .	0.000 mA
16.59	<i>AI3 HW switch pos</i>	(Visible when 16.01 Module 3 type = FIO-11) See parameter 14.59 <i>AI3 HW switch pos</i> .	-
16.60	<i>AI3 unit selection</i>	(Visible when 16.01 Module 3 type = FIO-11) See parameter 14.60 <i>AI3 unit selection</i> .	<i>mA</i>
16.61	<i>AI3 filter gain</i>	(Visible when 16.01 Module 3 type = FIO-11) See parameter 14.61 <i>AI3 filter gain</i> .	<i>No filtering</i>
16.62	<i>AI3 filter time</i>	(Visible when 16.01 Module 3 type = FIO-11) See parameter 14.62 <i>AI3 filter time</i> .	0.100 s
16.63	<i>AI3 min</i>	(Visible when 16.01 Module 3 type = FIO-11) See parameter 14.63 <i>AI3 min</i> .	0.000 mA or V
16.64	<i>AI3 max</i>	(Visible when 16.01 Module 3 type = FIO-11) See parameter 14.64 <i>AI3 max</i> .	10.000 mA or V
16.65	<i>AI3 scaled at AI3 min</i>	(Visible when 16.01 Module 3 type = FIO-11) See parameter 14.65 <i>AI3 scaled at AI3 min</i> .	0.000
16.66	<i>AI3 scaled at AI3 max</i>	(Visible when 16.01 Module 3 type = FIO-11) See parameter 14.66 <i>AI3 scaled at AI3 max</i> .	1500.0
16.71	<i>AO force selection</i>	(Visible when 16.01 Module 3 type = FIO-11) See parameter 14.71 <i>AO force selection</i> .	00000000h
16.76	<i>AO1 actual value</i>	(Visible when 16.01 Module 3 type = FIO-11) See parameter 14.76 <i>AO1 actual value</i> .	-
16.77	<i>AO1 source</i>	(Visible when 16.01 Module 3 type = FIO-11) See parameter 14.77 <i>AO1 source</i> .	<i>Zero</i>
16.78	<i>AO1 force data</i>	(Visible when 16.01 Module 3 type = FIO-11) See parameter 14.78 <i>AO1 force data</i> .	0.000 mA
16.79	<i>AO1 filter time</i>	(Visible when 16.01 Module 3 type = FIO-11) See parameter 14.79 <i>AO1 filter time</i> .	0.100 s

## 130 Parameters

No.	Name/Value	Description	Def/FbEq16
16.80	AO1 source min	(Visible when 16.01 Module 3 type = FIO-11) See parameter 14.80 AO1 source min.	0.0
16.81	AO1 source max	(Visible when 16.01 Module 3 type = FIO-11) See parameter 14.81 AO1 source max.	1500.0
16.82	AO1 out at AO1 src min	(Visible when 16.01 Module 3 type = FIO-11) See parameter 14.82 AO1 out at AO1 src min.	0.000 mA
16.83	AO1 out at AO1 src max	(Visible when 16.01 Module 3 type = FIO-11) See parameter 14.83 AO1 out at AO1 src max.	20.000 mA

<b>19 Operation mode</b>		Selection of external control location sources and operating modes. See also section <a href="#">Operating modes of the drive</a> (page 20).	
19.01	Actual operation mode	Displays the operation mode currently used. See parameters 19.11...19.14. This parameter is read-only.	-
	Zero	None.	1
	Speed	Speed control (in DTC motor control mode).	2
	Torque	Torque control (in DTC motor control mode).	3
	Min	The torque selector is comparing the output of the speed controller ( <a href="#">25.01 Torque reference speed control</a> ) and torque reference ( <a href="#">26.74 Torque ref ramp out</a> ) and the smaller of the two is used.	4
	Max	The torque selector is comparing the output of the speed controller ( <a href="#">25.01 Torque reference speed control</a> ) and torque reference ( <a href="#">26.74 Torque ref ramp out</a> ) and the greater of the two is used.	5
	Add	The speed controller output is added to the torque reference.	6
	Scalar (Hz)	Frequency control in scalar motor control mode.	10
	Scalar (rpm)	Speed control in scalar motor control mode.	11
	Forced magn.	Motor is in magnetizing mode.	20
19.11	Ext1/Ext2 selection	Selects the source for external control location EXT1/EXT2 selection. 0 = EXT1 1 = EXT2	<b>EXT1</b>
	EXT1	EXT1.	0
	EXT2	EXT2.	1
	MCW bit11: Ext ctrl loc	<a href="#">06.01 Main control word</a> (page 88), bit 11.	2
	DI1	Digital input DI1 ( <a href="#">10.02 DI delayed status</a> , bit 0).	3
	DI2	Digital input DI2 ( <a href="#">10.02 DI delayed status</a> , bit 1).	4
	DI3	Digital input DI3 ( <a href="#">10.02 DI delayed status</a> , bit 2).	5
	DI4	Digital input DI4 ( <a href="#">10.02 DI delayed status</a> , bit 3).	6
	DI5	Digital input DI5 ( <a href="#">10.02 DI delayed status</a> , bit 4).	7
	DI6	Digital input DI6 ( <a href="#">10.02 DI delayed status</a> , bit 5).	8
	DIO1	Digital input/output DIO1 ( <a href="#">11.02 DIO delayed status</a> , bit 0).	11
	DIO2	Digital input/output DIO2 ( <a href="#">11.02 DIO delayed status</a> , bit 1).	12
	<b>Other [bit]</b>	Source selection (see <a href="#">Terms and abbreviations</a> on page 81).	-

No.	Name/Value	Description	Def/FbEq16
19.12	<i>Ext1 control mode 1</i>	Selects the operating mode for external control location EXT1.	<i>Speed</i>
	Zero	None.	1
	Speed	Speed control. The torque reference used is <i>25.01 Torque reference speed control</i> (output of the speed reference chain).	2
	Torque	Torque control. The torque reference used is <i>26.74 Torque ref ramp out</i> (output of the torque reference chain).	3
	Minimum	Combination of selections <i>Speed</i> and <i>Torque</i> : the torque selector compares the speed controller output ( <i>25.01 Torque reference speed control</i> ) and the torque reference ( <i>26.74 Torque ref ramp out</i> ) and selects the smaller of the two. If speed error becomes negative, the drive follows the speed controller output until speed error becomes positive again. This prevents the drive from accelerating uncontrollably if the load is lost in torque control.	4
	Maximum	Combination of selections <i>Speed</i> and <i>Torque</i> : the torque selector compares the speed controller output ( <i>25.01 Torque reference speed control</i> ) and the torque reference ( <i>26.74 Torque ref ramp out</i> ) and selects the greater of the two. If speed error becomes positive, the drive follows the speed controller output until speed error becomes negative again. This prevents the drive from accelerating uncontrollably if the load is lost in torque control.	5
	Add	Combination of selections <i>Speed</i> and <i>Torque</i> : Torque selector adds the speed reference chain output to the torque reference chain output.	6
19.14	<i>Ext2 control mode 1</i>	Selects the operating mode for external control location EXT2. For the selections, see parameter <i>19.12 Ext1 control mode 1</i> .	<i>Speed</i>
19.16	<i>Local control mode</i>	Selects the operating mode for local control.	<i>Speed</i>
	Speed	Speed control. The torque reference used is <i>25.01 Torque reference speed control</i> (output of the speed reference chain).	0
	Torque	Torque control. The torque reference used is <i>26.74 Torque ref ramp out</i> (output of the torque reference chain).	1
19.17	<i>Local control disable</i>	Enables/disables local control.  <b>WARNING!</b> Before disabling local control, ensure that the control panel is not needed for stopping the drive.	<i>No</i>
	No	Local control enabled.	0
	Yes	Local control disabled.	1
19.20	<i>Scalar control reference unit</i>	Selects the reference type for scalar motor control mode. See also section <i>Operating modes of the drive</i> (page 20), and parameter <i>99.04 Motor ctrl mode</i> .	<i>Rpm</i>
	Hz	Hz. The reference is taken from parameter <i>28.02 Frequency ref ramp out</i> (output of the frequency control chain).	0
	Rpm	Rpm. The reference is taken from parameter <i>23.02 Speed ref ramp out</i> (speed reference after ramping and shaping).	1

No.	Name/Value	Description	Def/FbEq16																					
	<b>20 Start/stop/direction</b>	Start/stop/direction and run/start/jog enable signal source selection; positive/negative reference enable signal source selection. For information on control locations, see section <i>Local control vs. external control</i> (page 18).																						
20.01	<i>Ext1 commands</i>	Selects the source of start, stop and direction commands for external control location 1 (EXT1). See also parameters 20.02...20.05.	<i>In1 Start; In2 Dir</i>																					
	Not selected	No start or stop command sources selected.	0																					
	In1 Start	The source of the start and stop commands is selected by parameter 20.03 <i>Ext1 in1</i> . The state transitions of the source bits are interpreted as follows: <table border="1" data-bbox="482 703 969 853"> <thead> <tr> <th>State of source 1 (20.03)</th> <th>Command</th> </tr> </thead> <tbody> <tr> <td>0 -&gt; 1 (20.02 = Edge)</td> <td>Start</td> </tr> <tr> <td>1 (20.02 = Level)</td> <td>Stop</td> </tr> <tr> <td>0</td> <td>Stop</td> </tr> </tbody> </table>	State of source 1 (20.03)	Command	0 -> 1 (20.02 = Edge)	Start	1 (20.02 = Level)	Stop	0	Stop	1													
State of source 1 (20.03)	Command																							
0 -> 1 (20.02 = Edge)	Start																							
1 (20.02 = Level)	Stop																							
0	Stop																							
	In1 Start; In2 Dir	The source selected by 20.03 <i>Ext1 in1</i> is the start signal; the source selected by 20.04 <i>Ext1 in2</i> determines the direction. The state transitions of the source bits are interpreted as follows: <table border="1" data-bbox="482 1028 1193 1211"> <thead> <tr> <th>State of source 1 (20.03)</th> <th>State of source 2 (20.04)</th> <th>Command</th> </tr> </thead> <tbody> <tr> <td>0</td> <td>Any</td> <td>Stop</td> </tr> <tr> <td>0 -&gt; 1 (20.02 = Edge)</td> <td>0</td> <td>Start forward</td> </tr> <tr> <td>1 (20.02 = Level)</td> <td>1</td> <td>Start reverse</td> </tr> </tbody> </table>	State of source 1 (20.03)	State of source 2 (20.04)	Command	0	Any	Stop	0 -> 1 (20.02 = Edge)	0	Start forward	1 (20.02 = Level)	1	Start reverse	2									
State of source 1 (20.03)	State of source 2 (20.04)	Command																						
0	Any	Stop																						
0 -> 1 (20.02 = Edge)	0	Start forward																						
1 (20.02 = Level)	1	Start reverse																						
	In1 Start fwd; In2 Start rev	The source selected by 20.03 <i>Ext1 in1</i> is the forward start signal; the source selected by 20.04 <i>Ext1 in2</i> is the reverse start signal. The state transitions of the source bits are interpreted as follows: <table border="1" data-bbox="482 1391 1193 1677"> <thead> <tr> <th>State of source 1 (20.03)</th> <th>State of source 2 (20.04)</th> <th>Command</th> </tr> </thead> <tbody> <tr> <td>0</td> <td>0</td> <td>Stop</td> </tr> <tr> <td>0 -&gt; 1 (20.02 = Edge)</td> <td>0</td> <td>Start forward</td> </tr> <tr> <td>1 (20.02 = Level)</td> <td>0</td> <td>Start forward</td> </tr> <tr> <td>0</td> <td>0 -&gt; 1 (20.02 = Edge)</td> <td>Start reverse</td> </tr> <tr> <td>1</td> <td>1 (20.02 = Level)</td> <td>Start reverse</td> </tr> <tr> <td>1</td> <td>1</td> <td>Stop</td> </tr> </tbody> </table>	State of source 1 (20.03)	State of source 2 (20.04)	Command	0	0	Stop	0 -> 1 (20.02 = Edge)	0	Start forward	1 (20.02 = Level)	0	Start forward	0	0 -> 1 (20.02 = Edge)	Start reverse	1	1 (20.02 = Level)	Start reverse	1	1	Stop	3
State of source 1 (20.03)	State of source 2 (20.04)	Command																						
0	0	Stop																						
0 -> 1 (20.02 = Edge)	0	Start forward																						
1 (20.02 = Level)	0	Start forward																						
0	0 -> 1 (20.02 = Edge)	Start reverse																						
1	1 (20.02 = Level)	Start reverse																						
1	1	Stop																						

No.	Name/Value	Description	Def/FbEq16																
	In1P Start; In2 Stop	<p>The sources of the start and stop commands are selected by parameters <a href="#">20.03 Ext1 in1</a> and <a href="#">20.04 Ext1 in2</a>. The state transitions of the source bits are interpreted as follows:</p> <table border="1" data-bbox="555 360 1266 506"> <thead> <tr> <th data-bbox="555 360 820 427">State of source 1 (20.03)</th> <th data-bbox="820 360 1085 427">State of source 2 (20.04)</th> <th data-bbox="1085 360 1266 427">Command</th> </tr> </thead> <tbody> <tr> <td data-bbox="555 427 820 461">0 -&gt; 1</td> <td data-bbox="820 427 1085 461">1</td> <td data-bbox="1085 427 1266 461">Start</td> </tr> <tr> <td data-bbox="555 461 820 506">Any</td> <td data-bbox="820 461 1085 506">0</td> <td data-bbox="1085 461 1266 506">Stop</td> </tr> </tbody> </table> <p><b>Notes:</b></p> <ul style="list-style-type: none"> <li>Parameter <a href="#">20.02 Ext1 start trigger</a> has no effect with this setting.</li> <li>When source 2 is 0, the Start and Stop keys on the control panel are disabled.</li> </ul>	State of source 1 (20.03)	State of source 2 (20.04)	Command	0 -> 1	1	Start	Any	0	Stop	4							
State of source 1 (20.03)	State of source 2 (20.04)	Command																	
0 -> 1	1	Start																	
Any	0	Stop																	
	In1P Start; In2 Stop; In3 Dir	<p>The sources of the start and stop commands are selected by parameters <a href="#">20.03 Ext1 in1</a> and <a href="#">20.04 Ext1 in2</a>. The source selected by <a href="#">20.05 Ext1 in3</a> determines the direction. The state transitions of the source bits are interpreted as follows:</p> <table border="1" data-bbox="555 846 1266 1059"> <thead> <tr> <th data-bbox="555 846 733 936">State of source 1 (20.03)</th> <th data-bbox="733 846 912 936">State of source 2 (20.04)</th> <th data-bbox="912 846 1091 936">State of source 3 (20.05)</th> <th data-bbox="1091 846 1266 936">Command</th> </tr> </thead> <tbody> <tr> <td data-bbox="555 936 733 969">0 -&gt; 1</td> <td data-bbox="733 936 912 969">1</td> <td data-bbox="912 936 1091 969">0</td> <td data-bbox="1091 936 1266 969">Start forward</td> </tr> <tr> <td data-bbox="555 969 733 1003">0 -&gt; 1</td> <td data-bbox="733 969 912 1003">1</td> <td data-bbox="912 969 1091 1003">1</td> <td data-bbox="1091 969 1266 1003">Start reverse</td> </tr> <tr> <td data-bbox="555 1003 733 1059">Any</td> <td data-bbox="733 1003 912 1059">0</td> <td data-bbox="912 1003 1091 1059">Any</td> <td data-bbox="1091 1003 1266 1059">Stop</td> </tr> </tbody> </table> <p><b>Notes:</b></p> <ul style="list-style-type: none"> <li>Parameter <a href="#">20.02 Ext1 start trigger</a> has no effect with this setting.</li> <li>When source 2 is 0, the Start and Stop keys on the control panel are disabled.</li> </ul>	State of source 1 (20.03)	State of source 2 (20.04)	State of source 3 (20.05)	Command	0 -> 1	1	0	Start forward	0 -> 1	1	1	Start reverse	Any	0	Any	Stop	5
State of source 1 (20.03)	State of source 2 (20.04)	State of source 3 (20.05)	Command																
0 -> 1	1	0	Start forward																
0 -> 1	1	1	Start reverse																
Any	0	Any	Stop																
	In1P Start fwd; In2P Start rev; In3 Stop	<p>The sources of the start and stop commands are selected by parameters <a href="#">20.03 Ext1 in1</a>, <a href="#">20.04 Ext1 in2</a> and <a href="#">20.05 Ext1 in3</a>. The source selected by <a href="#">20.05 Ext1 in3</a> determines the direction. The state transitions of the source bits are interpreted as follows:</p> <table border="1" data-bbox="555 1429 1266 1641"> <thead> <tr> <th data-bbox="555 1429 733 1518">State of source 1 (20.03)</th> <th data-bbox="733 1429 912 1518">State of source 2 (20.04)</th> <th data-bbox="912 1429 1091 1518">State of source 3 (20.05)</th> <th data-bbox="1091 1429 1266 1518">Command</th> </tr> </thead> <tbody> <tr> <td data-bbox="555 1518 733 1552">0 -&gt; 1</td> <td data-bbox="733 1518 912 1552">Any</td> <td data-bbox="912 1518 1091 1552">1</td> <td data-bbox="1091 1518 1266 1552">Start forward</td> </tr> <tr> <td data-bbox="555 1552 733 1585">Any</td> <td data-bbox="733 1552 912 1585">0 -&gt; 1</td> <td data-bbox="912 1552 1091 1585">1</td> <td data-bbox="1091 1552 1266 1585">Start reverse</td> </tr> <tr> <td data-bbox="555 1585 733 1641">Any</td> <td data-bbox="733 1585 912 1641">Any</td> <td data-bbox="912 1585 1091 1641">0</td> <td data-bbox="1091 1585 1266 1641">Stop</td> </tr> </tbody> </table> <p><b>Note:</b> Parameter <a href="#">20.02 Ext1 start trigger</a> has no effect with this setting.</p>	State of source 1 (20.03)	State of source 2 (20.04)	State of source 3 (20.05)	Command	0 -> 1	Any	1	Start forward	Any	0 -> 1	1	Start reverse	Any	Any	0	Stop	6
State of source 1 (20.03)	State of source 2 (20.04)	State of source 3 (20.05)	Command																
0 -> 1	Any	1	Start forward																
Any	0 -> 1	1	Start reverse																
Any	Any	0	Stop																
	Fieldbus A	The start and stop commands are taken from fieldbus adapter A.	12																
	D2D or M/F link	The start and stop commands are taken from another drive through the D2D (Drive-to-drive) link or the master/follower link.	15																
	DDCS controller	The start and stop commands are taken from an external (DDCS) controller.	16																
	Application Program	The start and stop commands are taken from the application program control word (parameter <a href="#">06.02 Application control word</a> ).	21																

No.	Name/Value	Description	Def/FbEq16												
	ATF	Reserved.	22												
20.02	<i>Ext1 start trigger</i>	Defines whether the start signal for external control location EXT1 is edge-triggered or level-triggered. <b>Note:</b> This parameter is not effective if a pulse-type start signal is selected. See the descriptions of the selections of parameter <a href="#">20.01 Ext1 commands</a> .	<i>Edge</i>												
	Edge	The start signal is edge-triggered.	0												
	Level	The start signal is level-triggered.	1												
20.03	<i>Ext1 in1</i>	Selects source 1 for parameter <a href="#">20.01 Ext1 commands</a> .	<i>DI1</i>												
	Off	0.	0												
	On	1.	1												
	DI1	Digital input DI1 ( <a href="#">10.02 DI delayed status</a> , bit 0).	2												
	DI2	Digital input DI2 ( <a href="#">10.02 DI delayed status</a> , bit 1).	3												
	DI3	Digital input DI3 ( <a href="#">10.02 DI delayed status</a> , bit 2).	4												
	DI4	Digital input DI4 ( <a href="#">10.02 DI delayed status</a> , bit 3).	5												
	DI5	Digital input DI5 ( <a href="#">10.02 DI delayed status</a> , bit 4).	6												
	DI6	Digital input DI6 ( <a href="#">10.02 DI delayed status</a> , bit 5).	7												
	DIO1	Digital input/output DIO1 ( <a href="#">11.02 DIO delayed status</a> , bit 0).	10												
	DIO2	Digital input/output DIO2 ( <a href="#">11.02 DIO delayed status</a> , bit 1).	11												
	<i>Other [bit]</i>	Source selection (see <a href="#">Terms and abbreviations</a> on page 81).	-												
20.04	<i>Ext1 in2</i>	Selects source 2 for parameter <a href="#">20.01 Ext1 commands</a> . For the available selections, see parameter <a href="#">20.03 Ext1 in1</a> .	<i>DI2</i>												
20.05	<i>Ext1 in3</i>	Selects source 3 for parameter <a href="#">20.01 Ext1 commands</a> . For the available selections, see parameter <a href="#">20.03 Ext1 in1</a> .	<i>Off</i>												
20.06	<i>Ext2 commands</i>	Selects the source of start, stop and direction commands for external control location 2 (EXT2). See also parameters <a href="#">20.07...20.10</a> .	<i>Not selected</i>												
	Not selected	No start or stop command sources selected.	0												
	In1 Start	The source of the start and stop commands is selected by parameter <a href="#">20.08 Ext2 in1</a> . The state transitions of the source bits are interpreted as follows: <table border="1" data-bbox="482 1518 969 1664"> <thead> <tr> <th>State of source 1 (<a href="#">20.08</a>)</th> <th>Command</th> </tr> </thead> <tbody> <tr> <td>0 -&gt; 1 (<a href="#">20.07</a> = <i>Edge</i>)</td> <td>Start</td> </tr> <tr> <td>1 (<a href="#">20.07</a> = <i>Level</i>)</td> <td>Stop</td> </tr> <tr> <td>0</td> <td>Stop</td> </tr> </tbody> </table>	State of source 1 ( <a href="#">20.08</a> )	Command	0 -> 1 ( <a href="#">20.07</a> = <i>Edge</i> )	Start	1 ( <a href="#">20.07</a> = <i>Level</i> )	Stop	0	Stop	1				
State of source 1 ( <a href="#">20.08</a> )	Command														
0 -> 1 ( <a href="#">20.07</a> = <i>Edge</i> )	Start														
1 ( <a href="#">20.07</a> = <i>Level</i> )	Stop														
0	Stop														
	In1 Start; In2 Dir	The source selected by <a href="#">20.08 Ext2 in1</a> is the start signal; the source selected by <a href="#">20.09 Ext2 in2</a> determines the direction. The state transitions of the source bits are interpreted as follows: <table border="1" data-bbox="482 1843 1193 2022"> <thead> <tr> <th>State of source 1 (<a href="#">20.08</a>)</th> <th>State of source 2 (<a href="#">20.09</a>)</th> <th>Command</th> </tr> </thead> <tbody> <tr> <td>0</td> <td>Any</td> <td>Stop</td> </tr> <tr> <td>0 -&gt; 1 (<a href="#">20.07</a> = <i>Edge</i>)</td> <td>0</td> <td>Start forward</td> </tr> <tr> <td>1 (<a href="#">20.07</a> = <i>Level</i>)</td> <td>1</td> <td>Start reverse</td> </tr> </tbody> </table>	State of source 1 ( <a href="#">20.08</a> )	State of source 2 ( <a href="#">20.09</a> )	Command	0	Any	Stop	0 -> 1 ( <a href="#">20.07</a> = <i>Edge</i> )	0	Start forward	1 ( <a href="#">20.07</a> = <i>Level</i> )	1	Start reverse	2
State of source 1 ( <a href="#">20.08</a> )	State of source 2 ( <a href="#">20.09</a> )	Command													
0	Any	Stop													
0 -> 1 ( <a href="#">20.07</a> = <i>Edge</i> )	0	Start forward													
1 ( <a href="#">20.07</a> = <i>Level</i> )	1	Start reverse													

No.	Name/Value	Description	Def/FbEq16																
	In1 Start fwd; In2 Start rev	<p>The source selected by <a href="#">20.08 Ext2 in1</a> is the forward start signal; the source selected by <a href="#">20.09 Ext2 in2</a> is the reverse start signal. The state transitions of the source bits are interpreted as follows:</p> <table border="1" data-bbox="555 389 1271 678"> <thead> <tr> <th>State of source 1 (<a href="#">20.08</a>)</th> <th>State of source 2 (<a href="#">20.09</a>)</th> <th>Command</th> </tr> </thead> <tbody> <tr> <td>0</td> <td>0</td> <td>Stop</td> </tr> <tr> <td>0 -&gt; 1 (<a href="#">20.07 = Edge</a>) 1 (<a href="#">20.07 = Level</a>)</td> <td>0</td> <td>Start forward</td> </tr> <tr> <td>0</td> <td>0 -&gt; 1 (<a href="#">20.07 = Edge</a>) 1 (<a href="#">20.07 = Level</a>)</td> <td>Start reverse</td> </tr> <tr> <td>1</td> <td>1</td> <td>Stop</td> </tr> </tbody> </table>	State of source 1 ( <a href="#">20.08</a> )	State of source 2 ( <a href="#">20.09</a> )	Command	0	0	Stop	0 -> 1 ( <a href="#">20.07 = Edge</a> ) 1 ( <a href="#">20.07 = Level</a> )	0	Start forward	0	0 -> 1 ( <a href="#">20.07 = Edge</a> ) 1 ( <a href="#">20.07 = Level</a> )	Start reverse	1	1	Stop	3	
State of source 1 ( <a href="#">20.08</a> )	State of source 2 ( <a href="#">20.09</a> )	Command																	
0	0	Stop																	
0 -> 1 ( <a href="#">20.07 = Edge</a> ) 1 ( <a href="#">20.07 = Level</a> )	0	Start forward																	
0	0 -> 1 ( <a href="#">20.07 = Edge</a> ) 1 ( <a href="#">20.07 = Level</a> )	Start reverse																	
1	1	Stop																	
	In1P Start; In2 Stop	<p>The sources of the start and stop commands are selected by parameters <a href="#">20.08 Ext2 in1</a> and <a href="#">20.09 Ext2 in2</a>. The state transitions of the source bits are interpreted as follows:</p> <table border="1" data-bbox="555 831 1271 972"> <thead> <tr> <th>State of source 1 (<a href="#">20.08</a>)</th> <th>State of source 2 (<a href="#">20.09</a>)</th> <th>Command</th> </tr> </thead> <tbody> <tr> <td>0 -&gt; 1</td> <td>1</td> <td>Start</td> </tr> <tr> <td>Any</td> <td>0</td> <td>Stop</td> </tr> </tbody> </table> <p><b>Notes:</b></p> <ul style="list-style-type: none"> <li>Parameter <a href="#">20.07 Ext2 start trigger</a> has no effect with this setting.</li> <li>When source 2 is 0, the Start and Stop keys on the control panel are disabled.</li> </ul>	State of source 1 ( <a href="#">20.08</a> )	State of source 2 ( <a href="#">20.09</a> )	Command	0 -> 1	1	Start	Any	0	Stop	4							
State of source 1 ( <a href="#">20.08</a> )	State of source 2 ( <a href="#">20.09</a> )	Command																	
0 -> 1	1	Start																	
Any	0	Stop																	
	In1P Start; In2 Stop; In3 Dir	<p>The sources of the start and stop commands are selected by parameters <a href="#">20.08 Ext2 in1</a> and <a href="#">20.09 Ext2 in2</a>. The source selected by <a href="#">20.10 Ext2 in3</a> determines the direction. The state transitions of the source bits are interpreted as follows:</p> <table border="1" data-bbox="555 1317 1271 1525"> <thead> <tr> <th>State of source 1 (<a href="#">20.08</a>)</th> <th>State of source 2 (<a href="#">20.09</a>)</th> <th>State of source 3 (<a href="#">20.10</a>)</th> <th>Command</th> </tr> </thead> <tbody> <tr> <td>0 -&gt; 1</td> <td>1</td> <td>0</td> <td>Start forward</td> </tr> <tr> <td>0 -&gt; 1</td> <td>1</td> <td>1</td> <td>Start reverse</td> </tr> <tr> <td>Any</td> <td>0</td> <td>Any</td> <td>Stop</td> </tr> </tbody> </table> <p><b>Notes:</b></p> <ul style="list-style-type: none"> <li>Parameter <a href="#">20.07 Ext2 start trigger</a> has no effect with this setting.</li> <li>When source 2 is 0, the Start and Stop keys on the control panel are disabled.</li> </ul>	State of source 1 ( <a href="#">20.08</a> )	State of source 2 ( <a href="#">20.09</a> )	State of source 3 ( <a href="#">20.10</a> )	Command	0 -> 1	1	0	Start forward	0 -> 1	1	1	Start reverse	Any	0	Any	Stop	5
State of source 1 ( <a href="#">20.08</a> )	State of source 2 ( <a href="#">20.09</a> )	State of source 3 ( <a href="#">20.10</a> )	Command																
0 -> 1	1	0	Start forward																
0 -> 1	1	1	Start reverse																
Any	0	Any	Stop																

No.	Name/Value	Description	Def/FbEq16																
	In1P Start fwd; In2P Start rev; In3 Stop	<p>The sources of the start and stop commands are selected by parameters <a href="#">20.08 Ext2 in1</a>, <a href="#">20.09 Ext2 in2</a> and <a href="#">20.10 Ext2 in3</a>. The source selected by <a href="#">20.10 Ext2 in3</a> determines the direction. The state transitions of the source bits are interpreted as follows:</p> <table border="1"> <thead> <tr> <th>State of source 1 (<a href="#">20.08</a>)</th> <th>State of source 2 (<a href="#">20.09</a>)</th> <th>State of source 3 (<a href="#">20.10</a>)</th> <th>Command</th> </tr> </thead> <tbody> <tr> <td>0 -&gt; 1</td> <td>Any</td> <td>1</td> <td>Start forward</td> </tr> <tr> <td>Any</td> <td>0 -&gt; 1</td> <td>1</td> <td>Start reverse</td> </tr> <tr> <td>Any</td> <td>Any</td> <td>0</td> <td>Stop</td> </tr> </tbody> </table> <p><b>Note:</b> Parameter <a href="#">20.07 Ext2 start trigger</a> has no effect with this setting.</p>	State of source 1 ( <a href="#">20.08</a> )	State of source 2 ( <a href="#">20.09</a> )	State of source 3 ( <a href="#">20.10</a> )	Command	0 -> 1	Any	1	Start forward	Any	0 -> 1	1	Start reverse	Any	Any	0	Stop	6
State of source 1 ( <a href="#">20.08</a> )	State of source 2 ( <a href="#">20.09</a> )	State of source 3 ( <a href="#">20.10</a> )	Command																
0 -> 1	Any	1	Start forward																
Any	0 -> 1	1	Start reverse																
Any	Any	0	Stop																
	Fieldbus A	The start and stop commands are taken from fieldbus adapter A.	12																
	D2D or M/F link	The start and stop commands are taken from another drive through the D2D (Drive-to-drive) link or the master/follower link.	15																
	DDCS controller	The start and stop commands are taken from an external (DDCS) controller.	16																
	Application Program	The start and stop commands are taken from the application program control word (parameter <a href="#">06.02 Application control word</a> ).	21																
	ATF	Reserved.	22																
<a href="#">20.07</a>	<a href="#">Ext2 start trigger</a>	<p>Defines whether the start signal for external control location EXT2 is edge-triggered or level-triggered.</p> <p><b>Note:</b> In case the settings of parameters <a href="#">20.06</a> and <a href="#">20.07</a> are in conflict, the setting of parameter <a href="#">20.06</a> takes preference.</p>	<a href="#">Edge</a>																
	Edge	The start signal is edge-triggered.	0																
	Level	The start signal is level-triggered.	1																
<a href="#">20.08</a>	<a href="#">Ext2 in1</a>	<p>Selects source 1 for parameter <a href="#">20.06 Ext2 commands</a>. For the available selections, see parameter <a href="#">20.03 Ext1 in1</a>.</p>	<a href="#">Off</a>																
<a href="#">20.09</a>	<a href="#">Ext2 in2</a>	<p>Selects source 2 for parameter <a href="#">20.06 Ext2 commands</a>. For the available selections, see parameter <a href="#">20.03 Ext1 in1</a>.</p>	<a href="#">Off</a>																
<a href="#">20.10</a>	<a href="#">Ext2 in3</a>	<p>Selects source 3 for parameter <a href="#">20.06 Ext2 commands</a>. For the available selections, see parameter <a href="#">20.03 Ext1 in1</a>.</p>	<a href="#">Off</a>																
<a href="#">20.11</a>	<a href="#">Run enable stop mode</a>	<p>Selects the way the motor is stopped when the run enable signal switches off.</p> <p>The source of the run enable signal is selected by parameter <a href="#">20.12 Run enable 1</a>.</p>	<a href="#">Coast</a>																
	Coast	<p>Stop by switching off the output semiconductors of the drive. The motor coasts to a stop.</p> <p> <b>WARNING!</b> If a mechanical brake is used, ensure it is safe to stop the drive by coasting.</p>	0																
	Ramp	Stop along the active deceleration ramp. See parameter group <a href="#">23 Speed reference ramp</a> on page <a href="#">151</a> .	1																
	Torque limit	Stop according to torque limits (parameters <a href="#">30.19</a> and <a href="#">30.20</a> ).	2																



No.	Name/Value	Description	Def/FbEq16
20.12	<i>Run enable 1</i>	Selects the source of the external run enable signal. If the run enable signal is switched off, the drive will not start. If already running, the drive will stop according to the setting of parameter <i>20.11 Run enable stop mode</i> . 1 = Run enable signal on. <b>Note:</b> This parameter cannot be changed while the drive is running.	<i>On</i>
	Off	0.	0
	On	1.	1
	DI1	Digital input DI1 ( <i>10.02 DI delayed status</i> , bit 0).	2
	DI2	Digital input DI2 ( <i>10.02 DI delayed status</i> , bit 1).	3
	DI3	Digital input DI3 ( <i>10.02 DI delayed status</i> , bit 2).	4
	DI4	Digital input DI4 ( <i>10.02 DI delayed status</i> , bit 3).	5
	DI5	Digital input DI5 ( <i>10.02 DI delayed status</i> , bit 4).	6
	DI6	Digital input DI6 ( <i>10.02 DI delayed status</i> , bit 5).	7
	DIO1	Digital input/output DIO1 ( <i>11.02 DIO delayed status</i> , bit 0).	10
	DIO2	Digital input/output DIO2 ( <i>11.02 DIO delayed status</i> , bit 1).	11
	<i>Other [bit]</i>	Source selection (see <i>Terms and abbreviations</i> on page 81).	-
20.19	<i>Enable start command</i>	Selects the source for the start enable signal. 1 = Start enable. With the signal switched off, the drive will not start. (Switching the signal off while the drive is running will not stop the drive.)	<i>On</i>
	Off	0.	0
	On	1.	1
	DI1	Digital input DI1 ( <i>10.02 DI delayed status</i> , bit 0).	2
	DI2	Digital input DI2 ( <i>10.02 DI delayed status</i> , bit 1).	3
	DI3	Digital input DI3 ( <i>10.02 DI delayed status</i> , bit 2).	4
	DI4	Digital input DI4 ( <i>10.02 DI delayed status</i> , bit 3).	5
	DI5	Digital input DI5 ( <i>10.02 DI delayed status</i> , bit 4).	6
	DI6	Digital input DI6 ( <i>10.02 DI delayed status</i> , bit 5).	7
	DIO1	Digital input/output DIO1 ( <i>11.02 DIO delayed status</i> , bit 0).	10
	DIO2	Digital input/output DIO2 ( <i>11.02 DIO delayed status</i> , bit 1).	11
	<i>Other [bit]</i>	Source selection (see <i>Terms and abbreviations</i> on page 81).	-

No.	Name/Value	Description	Def/FbEq16
20.23	<i>Positive speed reference enable</i>	<p>Selects the source of the positive speed enable command.</p> <p>1 = Positive speed enabled.</p> <p>0 = Positive speed interpreted as zero speed reference. In the figure below, <i>23.01 Speed ref ramp in</i> is set to zero after the positive speed enable signal has cleared.</p> <p>Actions in different control modes:</p> <p>Speed control: Speed reference is set to zero and the motor is stopped along the currently active deceleration ramp. The rush controller prevents additional torque terms from running the motor in the positive direction.</p> <p>Torque control: The rush controller monitors the rotation direction of the motor.</p> <div data-bbox="279 674 1193 1099" style="text-align: center;"> </div> <p><b>Example:</b> The motor is rotating in the forward direction. To stop the motor, the positive speed enable signal is deactivated by a hardware limit switch (e.g. via digital input). If the positive speed enable signal remains deactivated and the negative speed enable signal is active, only reverse rotation of the motor is allowed.</p>	<i>On</i>
	Off	0.	0
	On	1.	1
	DI1	Digital input DI1 ( <i>10.02 DI delayed status</i> , bit 0).	2
	DI2	Digital input DI2 ( <i>10.02 DI delayed status</i> , bit 1).	3
	DI3	Digital input DI3 ( <i>10.02 DI delayed status</i> , bit 2).	4
	DI4	Digital input DI4 ( <i>10.02 DI delayed status</i> , bit 3).	5
	DI5	Digital input DI5 ( <i>10.02 DI delayed status</i> , bit 4).	6
	DI6	Digital input DI6 ( <i>10.02 DI delayed status</i> , bit 5).	7
	DIO1	Digital input/output DIO1 ( <i>11.02 DIO delayed status</i> , bit 0).	10
	DIO2	Digital input/output DIO2 ( <i>11.02 DIO delayed status</i> , bit 1).	11
	<i>Other [bit]</i>	Source selection (see <i>Terms and abbreviations</i> on page 81).	-
20.24	<i>Negative speed reference enable</i>	<p>Selects the source of the negative speed reference enable command. See parameter <i>20.23 Positive speed reference enable</i>.</p>	<i>On</i>

No.	Name/Value	Description	Def/FbEq16
20.25	<i>Jogging enable</i>	Selects the source for enabling parameters <a href="#">20.26 Jogging 1 start</a> and <a href="#">20.27 Jogging 2 start</a> . 1 = Jogging is enabled. 0 = Jogging is disabled. <b>Note:</b> Jogging can be enabled using this parameter only when no start command from an external control location is active. On the other hand, if jogging is already enabled, the drive cannot be started from an external control location apart from jog commands through fieldbus.	<i>Off</i>
	Off	0.	0
	On	1.	1
	DI1	Digital input DI1 ( <a href="#">10.02 DI delayed status</a> , bit 0).	2
	DI2	Digital input DI2 ( <a href="#">10.02 DI delayed status</a> , bit 1).	3
	DI3	Digital input DI3 ( <a href="#">10.02 DI delayed status</a> , bit 2).	4
	DI4	Digital input DI4 ( <a href="#">10.02 DI delayed status</a> , bit 3).	5
	DI5	Digital input DI5 ( <a href="#">10.02 DI delayed status</a> , bit 4).	6
	DI6	Digital input DI6 ( <a href="#">10.02 DI delayed status</a> , bit 5).	7
	DIO1	Digital input/output DIO1 ( <a href="#">11.02 DIO delayed status</a> , bit 0).	10
	DIO2	Digital input/output DIO2 ( <a href="#">11.02 DIO delayed status</a> , bit 1).	11
	<i>Other [bit]</i>	Source selection (see <a href="#">Terms and abbreviations</a> on page 81).	-
20.26	<i>Jogging 1 start</i>	If enabled by parameter <a href="#">20.25 Jogging enable</a> , selects the source for the activation of jogging function 1. (Jogging function 1 can also be activated through fieldbus regardless of parameter <a href="#">20.25</a> .) 1 = Active. <b>Notes:</b> • The jogging functions can only be used in speed and frequency (scalar) control. • This parameter cannot be changed while the drive is running.	<i>Off</i>
	Off	0.	0
	On	1.	1
	DI1	Digital input DI1 ( <a href="#">10.02 DI delayed status</a> , bit 0).	2
	DI2	Digital input DI2 ( <a href="#">10.02 DI delayed status</a> , bit 1).	3
	DI3	Digital input DI3 ( <a href="#">10.02 DI delayed status</a> , bit 2).	4
	DI4	Digital input DI4 ( <a href="#">10.02 DI delayed status</a> , bit 3).	5
	DI5	Digital input DI5 ( <a href="#">10.02 DI delayed status</a> , bit 4).	6
	DI6	Digital input DI6 ( <a href="#">10.02 DI delayed status</a> , bit 5).	7
	DIO1	Digital input/output DIO1 ( <a href="#">11.02 DIO delayed status</a> , bit 0).	10
	DIO2	Digital input/output DIO2 ( <a href="#">11.02 DIO delayed status</a> , bit 1).	11
	<i>Other [bit]</i>	Source selection (see <a href="#">Terms and abbreviations</a> on page 81).	-

No.	Name/Value	Description	Def/FbEq16
20.27	<i>Jogging 2 start</i>	<p>If enabled by parameter <a href="#">20.25 Jogging enable</a>, selects the source for the activation of jogging function 2. (Jogging function 2 can also be activated through fieldbus regardless of parameter <a href="#">20.25</a>.)</p> <p>1 = Active.</p> <p>For the selections, see parameter <a href="#">20.26 Jogging 1 start</a>.</p> <p><b>Notes:</b></p> <ul style="list-style-type: none"> <li>• Jogging function 1 has priority over jogging function 2.</li> <li>• This parameter cannot be changed while the drive is running.</li> </ul>	<i>Off</i>
<b>21 Start/stop mode</b>		Start and stop modes; emergency stop mode and signal source selection; DC magnetization settings; autophasing mode selection.	
21.01	<i>Start mode</i>	<p>Selects the motor start function.</p> <p>See also section <a href="#">DC magnetization</a> (page 43).</p> <p><b>Notes:</b></p> <ul style="list-style-type: none"> <li>• Selections <i>Fast</i> and <i>Const time</i> are ignored if parameter <a href="#">99.04 Motor ctrl mode</a> is set to <i>Scalar</i>.</li> <li>• Starting to a rotating machine is not possible when DC magnetizing is selected (<i>Fast</i> or <i>Const time</i>).</li> <li>• With permanent magnet motors, <i>Automatic</i> start mode must be used.</li> <li>• This parameter cannot be changed while the drive is running.</li> </ul>	<i>Automatic</i>
	Fast	The drive pre-magnetizes the motor before start. The pre-magnetizing time is determined automatically, being typically 200 ms to 2 s depending on motor size. This mode should be selected if a high break-away torque is required.	0
	Const time	<p>The drive pre-magnetizes the motor before start. The pre-magnetizing time is defined by parameter <a href="#">21.02 Magnetization time</a>. This mode should be selected if constant pre-magnetizing time is required (e.g. if the motor start must be synchronized with the release of a mechanical brake). This setting also guarantees the highest possible break-away torque when the pre-magnetizing time is set long enough.</p> <p> <b>WARNING!</b> The drive will start after the set magnetizing time has passed even if motor magnetization is not completed. In applications where a full break-away torque is essential, ensure that the constant magnetizing time is long enough to allow generation of full magnetization and torque.</p>	1
	Automatic	<p>Automatic start guarantees optimal motor start in most cases. It includes the flying start function (starting to a rotating machine) and the automatic restart function (a stopped motor can be restarted immediately without waiting the motor flux to die away). The drive motor control program identifies the flux as well as the mechanical state of the motor and starts the motor instantly under all conditions.</p> <p><b>Note:</b> If parameter <a href="#">99.04 Motor ctrl mode</a> is set to <i>Scalar</i>, no flying start or automatic restart is possible by default.</p>	2

No.	Name/Value	Description	Def/FbEq16										
21.02	<i>Magnetization time</i>	<p>Defines the pre-magnetization time.</p> <p>After the start command, the drive automatically premagnetizes the motor for the set time. To ensure full magnetizing, set this parameter to the same value as or higher than the rotor time constant. If not known, use the rule-of-thumb value given in the table below:</p> <table border="1"> <thead> <tr> <th>Motor rated power</th> <th>Constant magnetizing time</th> </tr> </thead> <tbody> <tr> <td>&lt; 1 kW</td> <td>≥ 50 to 100 ms</td> </tr> <tr> <td>1 to 10 kW</td> <td>≥ 100 to 200 ms</td> </tr> <tr> <td>10 to 200 kW</td> <td>≥ 200 to 1000 ms</td> </tr> <tr> <td>200 to 1000 kW</td> <td>≥ 1000 to 2000 ms</td> </tr> </tbody> </table> <p><b>Note:</b> This parameter cannot be changed while the drive is running.</p>	Motor rated power	Constant magnetizing time	< 1 kW	≥ 50 to 100 ms	1 to 10 kW	≥ 100 to 200 ms	10 to 200 kW	≥ 200 to 1000 ms	200 to 1000 kW	≥ 1000 to 2000 ms	500 ms
Motor rated power	Constant magnetizing time												
< 1 kW	≥ 50 to 100 ms												
1 to 10 kW	≥ 100 to 200 ms												
10 to 200 kW	≥ 200 to 1000 ms												
200 to 1000 kW	≥ 1000 to 2000 ms												
	0 ... 10000 ms	Constant DC magnetizing time.	1 = 1 ms										
21.03	<i>Stop mode</i>	Selects the way the motor is stopped when a stop command is received.	<i>Coast</i>										
	Coast	<p>Stop by switching off the output semiconductors of the drive. The motor coasts to a stop.</p> <p> <b>WARNING!</b> If a mechanical brake is used, ensure it is safe to stop the drive by coasting.</p>	0										
	Ramp	Stop along the active deceleration ramp. See parameter group <a href="#">23 Speed reference ramp</a> on page 151.	1										
	Torque limit	Stop according to torque limits (parameters <a href="#">30.19</a> and <a href="#">30.20</a> ).	2										
21.04	<i>Emergency stop mode</i>	<p>Selects the way the motor is stopped when an emergency stop command is received.</p> <p>The source of the emergency stop signal is selected by parameter <a href="#">21.05 Emergency stop source</a>.</p>	<i>Ramp stop (Off1)</i>										
	Ramp stop (Off1)	<p>With the drive running:</p> <ul style="list-style-type: none"> <li>• 1 = Normal operation.</li> <li>• 0 = Normal stop along the standard deceleration ramp defined for the particular reference type (see section <a href="#">Reference ramping</a> [page 35]). The drive can be restarted by removing the emergency stop signal and switching the start signal from 0 to 1.</li> </ul> <p>With the drive stopped:</p> <ul style="list-style-type: none"> <li>• 1 = Starting allowed.</li> <li>• 0 = Starting not allowed.</li> </ul>	0										
	Coast stop (Off2)	<p>With the drive running:</p> <ul style="list-style-type: none"> <li>• 1 = Normal operation.</li> <li>• 0 = Stop by coasting. The drive can be restarted by restoring the start interlock signal and switching the start signal from 0 to 1.</li> </ul> <p>With the drive stopped:</p> <ul style="list-style-type: none"> <li>• 1 = Starting allowed.</li> <li>• 0 = Starting not allowed.</li> </ul>	1										

## 142 Parameters

No.	Name/Value	Description	Def/FbEq16
	Eme ramp stop (Off3)	<p>With the drive running:</p> <ul style="list-style-type: none"> <li>• 1 = Normal operation</li> <li>• 0 = Stop by ramping along emergency stop ramp defined by parameter <a href="#">23.23 Emergency stop time</a>. The drive can be restarted by removing the emergency stop signal and switching the start signal from 0 to 1.</li> </ul> <p>With the drive stopped:</p> <ul style="list-style-type: none"> <li>• 1 = Starting allowed</li> <li>• 0 = Starting not allowed</li> </ul>	2
<a href="#">21.05</a>	<a href="#">Emergency stop source</a>	<p>Selects the source of the emergency stop signal. The stop mode is selected by parameter <a href="#">21.04 Emergency stop mode</a>.</p> <p>0 = Emergency stop active 1 = Normal operation</p> <p><b>Note:</b> This parameter cannot be changed while the drive is running.</p>	<i>Inactive (true)</i>
	Active (false)	0.	0
	Inactive (true)	1.	1
	DIIL	DIIL input ( <a href="#">10.02 DI delayed status</a> , bit 15).	2
	DI1	Digital input DI1 ( <a href="#">10.02 DI delayed status</a> , bit 0).	3
	DI2	Digital input DI2 ( <a href="#">10.02 DI delayed status</a> , bit 1).	4
	DI3	Digital input DI3 ( <a href="#">10.02 DI delayed status</a> , bit 2).	5
	DI4	Digital input DI4 ( <a href="#">10.02 DI delayed status</a> , bit 3).	6
	DI5	Digital input DI5 ( <a href="#">10.02 DI delayed status</a> , bit 4).	7
	DI6	Digital input DI6 ( <a href="#">10.02 DI delayed status</a> , bit 5).	8
	DIO1	Digital input/output DIO1 ( <a href="#">11.02 DIO delayed status</a> , bit 0).	11
	DIO2	Digital input/output DIO2 ( <a href="#">11.02 DIO delayed status</a> , bit 1).	12
	<a href="#">Other [bit]</a>	Source selection (see <a href="#">Terms and abbreviations</a> on page 81).	-
<a href="#">21.06</a>	<a href="#">Zero speed limit</a>	<p>Defines the zero speed limit. The motor is stopped along a speed ramp until the defined zero speed limit is reached. After the zero speed delay, the motor coasts to a stop.</p>	30.00 rpm
	0.00 ... 30000.00 rpm	Zero speed limit.	See par. <a href="#">46.01</a>

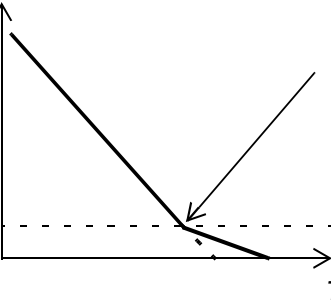
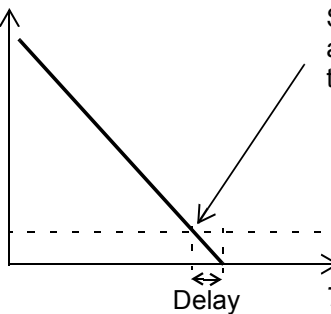
No.	Name/Value	Description	Def/FbEq16
21.07	<i>Zero speed delay</i>	<p>Defines the delay for the zero speed delay function. The function is useful in applications where a smooth and quick restarting is essential. During the delay, the drive knows the rotor position accurately.</p> <p><u>Without zero speed delay:</u> The drive receives a stop command and decelerates along a ramp. When actual motor speed falls below the value of parameter <i>21.06 Zero speed limit</i>, inverter modulation is stopped and the motor coasts to a standstill.</p> <p><i>Speed</i></p>  <p><i>Time</i></p> <p><u>With zero speed delay:</u> The drive receives a stop command and decelerates along a ramp. When actual motor speed falls below the value of parameter <i>21.06 Zero speed limit</i>, the zero speed delay function activates. During the delay the function keeps the speed controller live: the inverter modulates, motor is magnetized and the drive is ready for a quick restart. Zero speed delay can be used e.g. with the jogging function.</p> <p><i>Speed</i></p>  <p><i>Time</i></p> <p>Delay</p>	0 ms
	0 ... 30000 ms	Zero speed delay.	1 = 1 ms

No.	Name/Value	Description	Def/FbEq16								
21.08	<i>DC current control</i>	Activates/deactivates the DC hold and post-magnetization functions. See section <i>DC magnetization</i> (page 43). <b>Note:</b> DC magnetization causes the motor to heat up. In applications where long DC magnetization times are required, externally ventilated motors should be used. If the DC magnetization period is long, DC magnetization cannot prevent the motor shaft from rotating if a constant load is applied to the motor.	00b								
<table border="1"> <thead> <tr> <th>Bit</th> <th>Value</th> </tr> </thead> <tbody> <tr> <td>0</td> <td>1 = Enable DC hold. See section <i>DC hold</i> (page 44). <b>Notes:</b> <ul style="list-style-type: none"> <li>The DC hold function has no effect if the start signal is switched off.</li> <li>The DC hold function can only be activated in speed control mode.</li> <li>The DC hold function cannot be activated if parameter <i>99.04 Motor ctrl mode</i> is set to <i>Scalar</i>.</li> </ul> </td> </tr> <tr> <td>1</td> <td>1 = Enable post-magnetization. See section <i>Post-magnetization</i> (page 44). <b>Note:</b> Post-magnetization is only available when ramping is the selected stop mode (see parameter <i>21.03 Stop mode</i>).</td> </tr> <tr> <td>2...15</td> <td>Reserved</td> </tr> </tbody> </table>				Bit	Value	0	1 = Enable DC hold. See section <i>DC hold</i> (page 44). <b>Notes:</b> <ul style="list-style-type: none"> <li>The DC hold function has no effect if the start signal is switched off.</li> <li>The DC hold function can only be activated in speed control mode.</li> <li>The DC hold function cannot be activated if parameter <i>99.04 Motor ctrl mode</i> is set to <i>Scalar</i>.</li> </ul>	1	1 = Enable post-magnetization. See section <i>Post-magnetization</i> (page 44). <b>Note:</b> Post-magnetization is only available when ramping is the selected stop mode (see parameter <i>21.03 Stop mode</i> ).	2...15	Reserved
Bit	Value										
0	1 = Enable DC hold. See section <i>DC hold</i> (page 44). <b>Notes:</b> <ul style="list-style-type: none"> <li>The DC hold function has no effect if the start signal is switched off.</li> <li>The DC hold function can only be activated in speed control mode.</li> <li>The DC hold function cannot be activated if parameter <i>99.04 Motor ctrl mode</i> is set to <i>Scalar</i>.</li> </ul>										
1	1 = Enable post-magnetization. See section <i>Post-magnetization</i> (page 44). <b>Note:</b> Post-magnetization is only available when ramping is the selected stop mode (see parameter <i>21.03 Stop mode</i> ).										
2...15	Reserved										
	0000h...FFFFh	DC magnetization selection.	1 = 1								
21.09	<i>DC hold speed</i>	Defines the DC hold speed. See parameter <i>21.08 DC current control</i> , and section <i>DC hold</i> (page 44).	5.0 rpm								
	0.0 ... 1000.0 rpm	DC hold speed.	See par. <i>46.01</i>								
21.10	<i>DC current reference</i>	Defines the DC hold current in percent of the motor nominal current. See parameter <i>21.08 DC current control</i> , and section <i>DC magnetization</i> (page 43).	30.0%								
	0.0 ... 100.0%	DC hold current.	1 = 1%								
21.11	<i>Post magnetization time</i>	Defines the length of time for which post-magnetization is active after stopping the motor. The magnetization current is defined by parameter <i>21.10 DC current reference</i> . See parameter <i>21.08 DC current control</i> .	0 ms								
	0...30000 ms	Post-magnetization time.	1 = 1 ms								
21.13	<i>Autophasing mode</i>	Selects the way autophasing is performed during the ID run. See section <i>Autophasing</i> on page 41.	<i>Turning</i>								
	Turning	This mode gives the most accurate autophasing result. This mode can be used, and is recommended, if the motor is allowed to rotate during the ID run and the start-up is not time-critical. <b>Note:</b> This mode will cause the motor to rotate during the ID run.	0								
	Standstill 1	Faster than the <i>Turning</i> mode, but not as accurate. The motor will not rotate.	1								
	Standstill 2	An alternative standstill autophasing mode that can be used if the <i>Turning</i> mode cannot be used, and the <i>Standstill 1</i> mode gives erratic results. However, this mode is considerably slower than <i>Standstill 1</i> .	2								



No.	Name/Value	Description	Def/FbEq16
21.18	<i>Auto restart time</i>	The motor can be automatically started after a short supply power failure using the automatic restart function. See section <a href="#">Automatic restart</a> (page 54). When this parameter is set to 0.0 seconds, automatic restarting is disabled. Otherwise, the parameter defines the maximum duration of the power failure after which restarting is attempted. Note that this time also includes the DC pre-charging delay.	5.0 s
	0.0 s	Automatic restarting disabled.	0
	0.1 ... 5.0 s	Maximum power failure duration.	1 = 1 s
<b>22 Speed reference selection</b>		Speed reference selection. See the control chain diagrams on pages 348...350.	
22.01	<i>Speed ref unlimited</i>	Displays the output of the speed reference selection block. See the control chain diagram on page 349. This parameter is read-only.	-
	-30000.00 ... 30000.00 rpm	Value of the selected speed reference.	See par. 46.01
22.11	<i>Speed ref1 selection</i>	Selects speed reference source 1. See also parameter 22.13 <i>Speed ref1 function</i> .	<i>AI1 scaled</i>
	Zero	None.	0
	AI1 scaled	<a href="#">12.12 AI1 scaled value</a> (see page 102).	1
	AI2 scaled	<a href="#">12.22 AI2 scaled value</a> (see page 103).	2
	FB A ref1	<a href="#">03.05 FB A reference 1</a> (see page 85).	4
	FB A ref2	<a href="#">03.06 FB A reference 2</a> (see page 85).	5
	DDCS ctrl ref1	<a href="#">03.11 DDCS controller ref 1</a> (see page 85).	9
	DDCS ctrl ref2	<a href="#">03.12 DDCS controller ref 2</a> (see page 86).	10
	D2D or M/F reference 1	<a href="#">03.13 M/F or D2D ref1</a> (see page 86).	11
	D2D or M/F reference 2	<a href="#">03.14 M/F or D2D ref2</a> (see page 86).	12
	PID	<a href="#">40.01 Process PID actual value</a> (output of the process PID controller).	15
	Other	The value is taken from another parameter.	-
22.12	<i>Speed ref2 selection</i>	Selects speed reference source 2. For the selections, see parameter 22.11 <i>Speed ref1 selection</i> .	<i>Zero</i>
22.13	<i>Speed ref1 function</i>	Selects a mathematical function between the reference sources selected by parameters 22.11 <i>Speed ref1 selection</i> and 22.12 <i>Speed ref2 selection</i> . The result is available as <i>Speed reference 1</i> in parameter 22.14 <i>Speed ref1/2 selection</i> .	<i>Ref1</i>
	Ref1	Signal selected by 22.11 <i>Speed ref1 selection</i> is used as speed reference 1 as such.	0
	Add	The sum of the reference sources is used as speed reference 1.	1
	Sub	The subtraction ( $[22.11 \text{ Speed ref1 selection}] - [22.12 \text{ Speed ref2 selection}]$ ) of the reference sources is used as speed reference 1.	2

No.	Name/Value	Description	Def/FbEq16
	Mul	The multiplication of the reference sources is used as speed reference 1.	3
	Min	The smaller of the reference sources is used as speed reference 1.	4
	Max	The greater of the reference sources is used as speed reference 1.	5
<a href="#">22.14</a>	<a href="#">Speed ref1/2 selection</a>	Configures the selection between speed references 1 and 2. (The sources for the references are defined by parameters <a href="#">22.11 Speed ref1 selection</a> and <a href="#">22.12 Speed ref2 selection</a> respectively.) 0 = Speed reference 1 1 = Speed reference 2	<a href="#">Speed reference 1</a>
	Speed reference 1	0.	0
	Speed reference 2	1.	1
	MCW bit11: Ext ctrl loc	Bit 11 of <a href="#">06.01 Main control word</a> (page 88).	2
	DI1	Digital input DI1 ( <a href="#">10.02 DI delayed status</a> , bit 0).	3
	DI2	Digital input DI2 ( <a href="#">10.02 DI delayed status</a> , bit 1).	4
	DI3	Digital input DI3 ( <a href="#">10.02 DI delayed status</a> , bit 2).	5
	DI4	Digital input DI4 ( <a href="#">10.02 DI delayed status</a> , bit 3).	6
	DI5	Digital input DI5 ( <a href="#">10.02 DI delayed status</a> , bit 4).	7
	DI6	Digital input DI6 ( <a href="#">10.02 DI delayed status</a> , bit 5).	8
	DIO1	Digital input/output DIO1 ( <a href="#">11.02 DIO delayed status</a> , bit 0).	11
	DIO2	Digital input/output DIO2 ( <a href="#">11.02 DIO delayed status</a> , bit 1).	12
	<a href="#">Other [bit]</a>	A specific bit in another parameter.	-
<a href="#">22.15</a>	<a href="#">Additive speed ref1</a>	Defines a reference to be added to the speed reference after reference selection (see page 348). For the selections, see parameter <a href="#">22.11 Speed ref1 selection</a> . <b>Note:</b> For safety reasons, the additive is not applied when any of the stop functions are active.	<a href="#">Zero</a>
<a href="#">22.16</a>	<a href="#">Speed share</a>	Defines the scaling factor for speed reference 1/2 (speed reference 1 or 2 is multiplied by the defined value). Speed reference 1 or 2 is selected by parameter <a href="#">22.14 Speed ref1/2 selection</a> .	1.000
	-8.000 ...8.000	Speed reference scaling factor.	1000 = 1
<a href="#">22.17</a>	<a href="#">Additive speed ref2</a>	Defines a reference to be added to the speed reference after the speed share function (see page 348). For the selections, see parameter <a href="#">22.11 Speed ref1 selection</a> . <b>Note:</b> For safety reasons, the additive is not applied when any of the stop functions are active.	<a href="#">Zero</a>

No.	Name/Value	Description	Def/FbEq16																																				
22.21	<i>Constant speed function</i>	Determines how constant speeds are selected, and whether the rotation direction signal is considered or not when applying a constant speed.	00b																																				
		<table border="1"> <thead> <tr> <th>Bit</th> <th>Name</th> <th>Information</th> </tr> </thead> <tbody> <tr> <td>0</td> <td>Const speed mode</td> <td> <p>1 = Packed: 7 constant speeds are selectable using the three sources defined by parameters <a href="#">22.22</a>, <a href="#">22.23</a> and <a href="#">22.24</a>.</p> <p>0 = Separate: Constant speeds 1, 2 and 3 are separately activated by the sources defined by parameters <a href="#">22.22</a>, <a href="#">22.23</a> and <a href="#">22.24</a> respectively. In case of conflict, the constant speed with the smaller number takes priority.</p> </td> </tr> <tr> <td>1</td> <td>Dir ena</td> <td> <p>1 = Start dir: To determine running direction for a constant speed, the sign of the constant speed setting (parameters <a href="#">22.26...22.32</a>) is multiplied by the direction signal (forward: +1, reverse: -1). For example, if the direction signal is reverse and the active constant speed is negative, the drive will run in the forward direction.</p> <p>0 = Accord Par: The running direction for the constant speed is determined by the sign of the constant speed setting (parameters <a href="#">22.26...22.32</a>).</p> </td> </tr> <tr> <td>2...15</td> <td>Reserved</td> <td></td> </tr> </tbody> </table>	Bit	Name	Information	0	Const speed mode	<p>1 = Packed: 7 constant speeds are selectable using the three sources defined by parameters <a href="#">22.22</a>, <a href="#">22.23</a> and <a href="#">22.24</a>.</p> <p>0 = Separate: Constant speeds 1, 2 and 3 are separately activated by the sources defined by parameters <a href="#">22.22</a>, <a href="#">22.23</a> and <a href="#">22.24</a> respectively. In case of conflict, the constant speed with the smaller number takes priority.</p>	1	Dir ena	<p>1 = Start dir: To determine running direction for a constant speed, the sign of the constant speed setting (parameters <a href="#">22.26...22.32</a>) is multiplied by the direction signal (forward: +1, reverse: -1). For example, if the direction signal is reverse and the active constant speed is negative, the drive will run in the forward direction.</p> <p>0 = Accord Par: The running direction for the constant speed is determined by the sign of the constant speed setting (parameters <a href="#">22.26...22.32</a>).</p>	2...15	Reserved																										
Bit	Name	Information																																					
0	Const speed mode	<p>1 = Packed: 7 constant speeds are selectable using the three sources defined by parameters <a href="#">22.22</a>, <a href="#">22.23</a> and <a href="#">22.24</a>.</p> <p>0 = Separate: Constant speeds 1, 2 and 3 are separately activated by the sources defined by parameters <a href="#">22.22</a>, <a href="#">22.23</a> and <a href="#">22.24</a> respectively. In case of conflict, the constant speed with the smaller number takes priority.</p>																																					
1	Dir ena	<p>1 = Start dir: To determine running direction for a constant speed, the sign of the constant speed setting (parameters <a href="#">22.26...22.32</a>) is multiplied by the direction signal (forward: +1, reverse: -1). For example, if the direction signal is reverse and the active constant speed is negative, the drive will run in the forward direction.</p> <p>0 = Accord Par: The running direction for the constant speed is determined by the sign of the constant speed setting (parameters <a href="#">22.26...22.32</a>).</p>																																					
2...15	Reserved																																						
	0000h...FFFFh	Constant speeds configuration word.	1 = 1																																				
22.22	<i>Constant speed sel1</i>	When bit 0 of parameter <a href="#">22.21 Constant speed function</a> is 0 (Separate), selects a source that activates constant speed 1. When bit 0 of parameter <a href="#">22.21 Constant speed function</a> is 1 (Packed), this parameter and parameters <a href="#">22.23 Constant speed sel2</a> and <a href="#">22.24 Constant speed sel3</a> select three sources whose states activate constant speeds as follows:	<i>DI5</i>																																				
		<table border="1"> <thead> <tr> <th>Source defined by par. <a href="#">22.22</a></th> <th>Source defined by par. <a href="#">22.23</a></th> <th>Source defined by par. <a href="#">22.24</a></th> <th>Constant speed active</th> </tr> </thead> <tbody> <tr> <td>0</td> <td>0</td> <td>0</td> <td>None</td> </tr> <tr> <td>1</td> <td>0</td> <td>0</td> <td>Constant speed 1</td> </tr> <tr> <td>0</td> <td>1</td> <td>0</td> <td>Constant speed 2</td> </tr> <tr> <td>1</td> <td>1</td> <td>0</td> <td>Constant speed 3</td> </tr> <tr> <td>0</td> <td>0</td> <td>1</td> <td>Constant speed 4</td> </tr> <tr> <td>1</td> <td>0</td> <td>1</td> <td>Constant speed 5</td> </tr> <tr> <td>0</td> <td>1</td> <td>1</td> <td>Constant speed 6</td> </tr> <tr> <td>1</td> <td>1</td> <td>1</td> <td>Constant speed 7</td> </tr> </tbody> </table>	Source defined by par. <a href="#">22.22</a>	Source defined by par. <a href="#">22.23</a>	Source defined by par. <a href="#">22.24</a>	Constant speed active	0	0	0	None	1	0	0	Constant speed 1	0	1	0	Constant speed 2	1	1	0	Constant speed 3	0	0	1	Constant speed 4	1	0	1	Constant speed 5	0	1	1	Constant speed 6	1	1	1	Constant speed 7	
Source defined by par. <a href="#">22.22</a>	Source defined by par. <a href="#">22.23</a>	Source defined by par. <a href="#">22.24</a>	Constant speed active																																				
0	0	0	None																																				
1	0	0	Constant speed 1																																				
0	1	0	Constant speed 2																																				
1	1	0	Constant speed 3																																				
0	0	1	Constant speed 4																																				
1	0	1	Constant speed 5																																				
0	1	1	Constant speed 6																																				
1	1	1	Constant speed 7																																				
	Off	0.	0																																				
	On	1.	1																																				
	DI1	Digital input DI1 ( <a href="#">10.02 DI delayed status</a> , bit 0).	2																																				
	DI2	Digital input DI2 ( <a href="#">10.02 DI delayed status</a> , bit 1).	3																																				
	DI3	Digital input DI3 ( <a href="#">10.02 DI delayed status</a> , bit 2).	4																																				
	DI4	Digital input DI4 ( <a href="#">10.02 DI delayed status</a> , bit 3).	5																																				
	DI5	Digital input DI5 ( <a href="#">10.02 DI delayed status</a> , bit 4).	6																																				
	DI6	Digital input DI6 ( <a href="#">10.02 DI delayed status</a> , bit 5).	7																																				
	DIO1	Digital input/output DIO1 ( <a href="#">11.02 DIO delayed status</a> , bit 0).	10																																				

No.	Name/Value	Description	Def/FbEq16
	DIO2	Digital input/output DIO2 ( <a href="#">11.02 DIO delayed status</a> , bit 1).	11
	<i>Other [bit]</i>	Source selection (see <a href="#">Terms and abbreviations</a> on page 81).	-
<a href="#">22.23</a>	<a href="#">Constant speed sel2</a>	When bit 0 of parameter <a href="#">22.21 Constant speed function</a> is 0 (Separate), selects a source that activates constant speed 2. When bit 0 of parameter <a href="#">22.21 Constant speed function</a> is 1 (Packed), this parameter and parameters <a href="#">22.22 Constant speed sel1</a> and <a href="#">22.24 Constant speed sel3</a> select three sources that are used to activate constant speeds. See table at parameter <a href="#">22.22 Constant speed sel1</a> . For the selections, see parameter <a href="#">22.22 Constant speed sel1</a> .	<i>Off</i>
<a href="#">22.24</a>	<a href="#">Constant speed sel3</a>	When bit 0 of parameter <a href="#">22.21 Constant speed function</a> is 0 (Separate), selects a source that activates constant speed 3. When bit 0 of parameter <a href="#">22.21 Constant speed function</a> is 1 (Packed), this parameter and parameters <a href="#">22.22 Constant speed sel1</a> and <a href="#">22.23 Constant speed sel2</a> select three sources that are used to activate constant speeds. See table at parameter <a href="#">22.22 Constant speed sel1</a> . For the selections, see parameter <a href="#">22.22 Constant speed sel1</a> .	<i>Off</i>
<a href="#">22.26</a>	<a href="#">Constant speed 1</a>	Defines constant speed 1.	300.00 rpm
	-30000.00 ... 30000.00 rpm	Constant speed 1.	See par. <a href="#">46.01</a>
<a href="#">22.27</a>	<a href="#">Constant speed 2</a>	Defines constant speed 2.	0.00 rpm
	-30000.00 ... 30000.00 rpm	Constant speed 2.	See par. <a href="#">46.01</a>
<a href="#">22.28</a>	<a href="#">Constant speed 3</a>	Defines constant speed 3.	0.00 rpm
	-30000.00 ... 30000.00 rpm	Constant speed 3.	See par. <a href="#">46.01</a>
<a href="#">22.29</a>	<a href="#">Constant speed 4</a>	Defines constant speed 4.	0.00 rpm
	-30000.00 ... 30000.00 rpm	Constant speed 4.	See par. <a href="#">46.01</a>
<a href="#">22.30</a>	<a href="#">Constant speed 5</a>	Defines constant speed 5.	0.00 rpm
	-30000.00 ... 30000.00 rpm	Constant speed 5.	See par. <a href="#">46.01</a>
<a href="#">22.31</a>	<a href="#">Constant speed 6</a>	Defines constant speed 6.	0.00 rpm
	-30000.00 ... 30000.00 rpm	Constant speed 6.	See par. <a href="#">46.01</a>
<a href="#">22.32</a>	<a href="#">Constant speed 7</a>	Defines constant speed 7.	0.00 rpm
	-30000.00 ... 30000.00 rpm	Constant speed 7.	See par. <a href="#">46.01</a>
<a href="#">22.41</a>	<a href="#">Speed ref safe</a>	Defines a safe speed reference that is used with supervision parameters such as <ul style="list-style-type: none"> <li><a href="#">49.05 Communication loss action</a></li> <li><a href="#">50.02 FBA A comm loss func.</a></li> </ul>	0.00 rpm
	-30000.00 ... 30000.00 rpm	Safe speed reference.	See par. <a href="#">46.01</a>
<a href="#">22.42</a>	<a href="#">Jogging 1 ref</a>	Defines the speed reference for jogging function 1. For more information on jogging, see page <a href="#">38</a> .	0.00 rpm
	-30000.00 ... 30000.00 rpm	Speed reference for jogging function 1.	See par. <a href="#">46.01</a>

No.	Name/Value	Description	Def/FbEq16														
22.43	<i>Jogging 2 ref</i>	Defines the speed reference for jogging function 2. For more information on jogging, see page 38.	0.00 rpm														
	-30000.00 ... 30000.00 rpm	Speed reference for jogging function 2.	See par. <a href="#">46.01</a>														
22.51	<i>Critical speed function</i>	Enables/disables the critical speeds function. Also determines whether the specified ranges are effective in both rotating directions or not. See also section <i>Critical speeds (frequencies)</i> (page 36).	00b														
		<table border="1"> <thead> <tr> <th>Bit</th> <th>Name</th> <th>Information</th> </tr> </thead> <tbody> <tr> <td rowspan="2">0</td> <td rowspan="2">Enable</td> <td>1 = Enable: Critical speeds enabled.</td> </tr> <tr> <td>0 = Disable: Critical speeds disabled.</td> </tr> <tr> <td rowspan="2">1</td> <td rowspan="2">Sign mode</td> <td>1 = Signed: The signs of parameters <a href="#">22.52...22.57</a> are taken into account.</td> </tr> <tr> <td>0 = Absolute: Parameters <a href="#">22.52...22.57</a> are handled as absolute values. Each range is effective in both directions of rotation.</td> </tr> <tr> <td>2...15</td> <td>Reserved</td> <td></td> </tr> </tbody> </table>	Bit	Name	Information	0	Enable	1 = Enable: Critical speeds enabled.	0 = Disable: Critical speeds disabled.	1	Sign mode	1 = Signed: The signs of parameters <a href="#">22.52...22.57</a> are taken into account.	0 = Absolute: Parameters <a href="#">22.52...22.57</a> are handled as absolute values. Each range is effective in both directions of rotation.	2...15	Reserved		
Bit	Name	Information															
0	Enable	1 = Enable: Critical speeds enabled.															
		0 = Disable: Critical speeds disabled.															
1	Sign mode	1 = Signed: The signs of parameters <a href="#">22.52...22.57</a> are taken into account.															
		0 = Absolute: Parameters <a href="#">22.52...22.57</a> are handled as absolute values. Each range is effective in both directions of rotation.															
2...15	Reserved																
	0000h...FFFFh	Critical speeds configuration word.	1 = 1														
22.52	<i>Critical speed 1 low</i>	Defines the low limit for critical speed range 1. <b>Note:</b> This value must be less than or equal to the value of <a href="#">22.53 Critical speed 1 high</a> .	0.00 rpm														
	-30000.00 ... 30000.00 rpm	Low limit for critical speed 1.	See par. <a href="#">46.01</a>														
22.53	<i>Critical speed 1 high</i>	Defines the high limit for critical speed range 1. <b>Note:</b> This value must be greater than or equal to the value of <a href="#">22.52 Critical speed 1 low</a> .	0.00 rpm														
	-30000.00 ... 30000.00 rpm	High limit for critical speed 1.	See par. <a href="#">46.01</a>														
22.54	<i>Critical speed 2 low</i>	Defines the low limit for critical speed range 2. <b>Note:</b> This value must be less than or equal to the value of <a href="#">22.55 Critical speed 2 high</a> .	0.00 rpm														
	-30000.00 ... 30000.00 rpm	Low limit for critical speed 2.	See par. <a href="#">46.01</a>														
22.55	<i>Critical speed 2 high</i>	Defines the high limit for critical speed range 2. <b>Note:</b> This value must be greater than or equal to the value of <a href="#">22.54 Critical speed 2 low</a> .	0.00 rpm														
	-30000.00 ... 30000.00 rpm	High limit for critical speed 2.	See par. <a href="#">46.01</a>														
22.56	<i>Critical speed 3 low</i>	Defines the low limit for critical speed range 3. <b>Note:</b> This value must be less than or equal to the value of <a href="#">22.57 Critical speed 3 high</a> .	0.00 rpm														
	-30000.00 ... 30000.00 rpm	Low limit for critical speed 3.	See par. <a href="#">46.01</a>														
22.57	<i>Critical speed 3 high</i>	Defines the high limit for critical speed range 3. <b>Note:</b> This value must be greater than or equal to the value of <a href="#">22.56 Critical speed 3 low</a> .	0.00 rpm														
	-30000.00 ... 30000.00 rpm	High limit for critical speed 3.	See par. <a href="#">46.01</a>														

## 150 Parameters

No.	Name/Value	Description	Def/FbEq16
22.81	<a href="#">Speed reference 1 act</a>	Displays the value of speed reference source 1 (selected by parameter <a href="#">22.11 Speed ref1 selection</a> ). See the control chain diagram on page <a href="#">348</a> . This parameter is read-only.	-
	-30000.00 ... 30000.00 rpm	Value of reference source 1.	See par. <a href="#">46.01</a>
22.82	<a href="#">Speed reference 2 act</a>	Displays the value of speed reference source 2 (selected by parameter <a href="#">22.12 Speed ref2 selection</a> ). See the control chain diagram on page <a href="#">348</a> . This parameter is read-only.	-
	-30000.00 ... 30000.00 rpm	Value of reference source 2.	See par. <a href="#">46.01</a>
22.83	<a href="#">Speed reference 3 act</a>	Displays the value of speed reference after the mathematical function applied by parameter <a href="#">22.13 Speed ref1 function</a> and reference 1/2 selection ( <a href="#">22.14 Speed ref1/2 selection</a> ). See the control chain diagram on page <a href="#">348</a> . This parameter is read-only.	-
	-30000.00 ... 30000.00 rpm	Speed reference after source selection.	See par. <a href="#">46.01</a>
22.84	<a href="#">Speed reference 4 act</a>	Displays the value of speed reference after application of 1st speed additive ( <a href="#">22.15 Additive speed ref1</a> ). See the control chain diagram on page <a href="#">348</a> . This parameter is read-only.	-
	-30000.00 ... 30000.00 rpm	Speed reference after additive 1.	See par. <a href="#">46.01</a>
22.85	<a href="#">Speed reference 5 act</a>	Displays the value of speed reference after the application of the speed share scaling factor ( <a href="#">22.16 Speed share</a> ). See the control chain diagram on page <a href="#">348</a> . This parameter is read-only.	-
	-30000.00 ... 30000.00 rpm	Speed reference after speed share scaling.	See par. <a href="#">46.01</a>
22.86	<a href="#">Speed reference 6 act</a>	Displays the value of speed reference after application of 2nd speed additive ( <a href="#">22.17 Additive speed ref2</a> ). See the control chain diagram on page <a href="#">348</a> . This parameter is read-only.	-
	-30000.00 ... 30000.00 rpm	Speed reference after additive 2.	See par. <a href="#">46.01</a>
22.87	<a href="#">Speed reference 7 act</a>	Displays the value of speed reference before application of critical speeds. See the control chain diagram on page <a href="#">349</a> . The value is received from <a href="#">22.86 Speed reference 6 act</a> unless overridden by <ul style="list-style-type: none"> <li>• any constant speed</li> <li>• a jogging reference</li> <li>• <a href="#">network control</a> reference</li> <li>• control panel reference</li> <li>• safe speed reference.</li> </ul> This parameter is read-only.	-
	-30000.00 ... 30000.00 rpm	Speed reference before application of critical speeds.	See par. <a href="#">46.01</a>

No.	Name/Value	Description	Def/FbEq16
<b>23</b>	<b>Speed reference ramp</b>	Speed reference ramp settings. See the control chain diagram on page 350.	
23.01	Speed ref ramp in	Displays the used speed reference before ramping and shaping in rpm. See the control chain diagram on page 350. This parameter is read-only.	-
	-30000.00 ... 30000.00 rpm	Speed reference before ramping and shaping.	See par. 46.01
23.02	Speed ref ramp out	Displays the ramped and shaped speed reference in rpm. See the control chain diagram on page 350. This parameter is read-only.	-
	-30000.00 ... 30000.00 rpm	Speed reference after ramping and shaping.	See par. 46.01
23.11	Ramp set selection	Selects the source that switches between the two sets of acceleration/deceleration times defined by parameters 23.12...23.15. 0 = Acceleration time 1 and deceleration time 1 are in force 1 = Acceleration time 2 and deceleration time 2 are in force	D14
	Acc/Dec time 1	0.	1
	Acc/Dec time 2	1.	2
	DI1	Digital input DI1 (10.02 DI delayed status, bit 0).	2
	DI2	Digital input DI2 (10.02 DI delayed status, bit 1).	3
	DI3	Digital input DI3 (10.02 DI delayed status, bit 2).	4
	DI4	Digital input DI4 (10.02 DI delayed status, bit 3).	5
	DI5	Digital input DI5 (10.02 DI delayed status, bit 4).	6
	DI6	Digital input DI6 (10.02 DI delayed status, bit 5).	7
	DIO1	Digital input/output DIO1 (11.02 DIO delayed status, bit 0).	10
	DIO2	Digital input/output DIO2 (11.02 DIO delayed status, bit 1).	11
	Other [bit]	Source selection (see Terms and abbreviations on page 81).	-
23.12	Acceleration time 1	Defines acceleration time 1 as the time required for the speed to change from zero to the speed defined by parameter 46.01 Speed scaling. If the speed reference increases faster than the set acceleration rate, the motor speed will follow the acceleration rate. If the speed reference increases slower than the set acceleration rate, the motor speed will follow the reference. If the acceleration time is set too short, the drive will automatically prolong the acceleration in order not to exceed the drive torque limits.	20.000 s
	0.000 ...1800.000 s	Acceleration time 1.	10 = 1 s

No.	Name/Value	Description	Def/FbEq16
23.13	<i>Deceleration time 1</i>	<p>Defines deceleration time 1 as the time required for the speed to change from the speed defined by parameter <a href="#">46.01 Speed scaling</a> to zero.</p> <p>If the speed reference decreases slower than the set deceleration rate, the motor speed will follow the reference.</p> <p>If the reference changes faster than the set deceleration rate, the motor speed will follow the deceleration rate.</p> <p>If the deceleration rate is set too short, the drive will automatically prolong the deceleration in order not to exceed drive torque limits. If there is any doubt about the deceleration time being too short, ensure that DC overvoltage control is on (parameter <a href="#">30.30 Overvoltage control</a>).</p> <p><b>Note:</b> If a short deceleration time is needed for a high inertia application, the drive should be equipped with braking equipment such as a brake chopper and brake resistor.</p>	20.000 s
	0.000 ... 1800.000 s	Deceleration time 1.	10 = 1 s
23.14	<i>Acceleration time 2</i>	Defines acceleration time 2. See parameter <a href="#">23.12 Acceleration time 1</a> .	20.000 s
	0.000 ... 1800.000 s	Acceleration time 2.	10 = 1 s
23.15	<i>Deceleration time 2</i>	Defines deceleration time 2. See parameter <a href="#">23.13 Deceleration time 1</a> .	20.000 s
	0.000 ... 1800.000 s	Deceleration time 2.	10 = 1 s

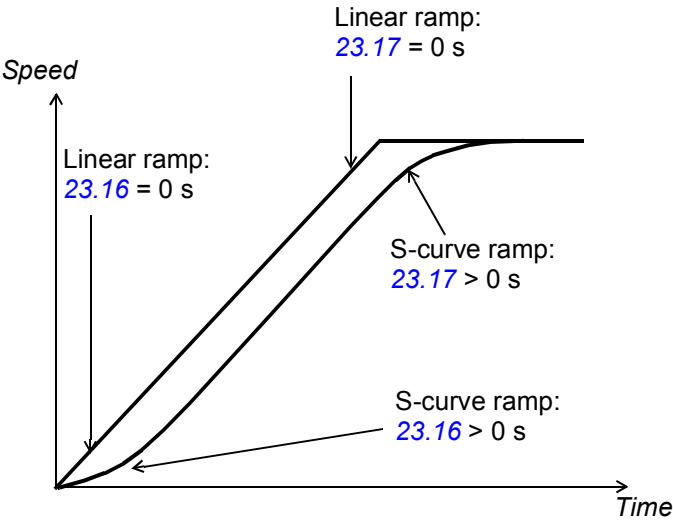
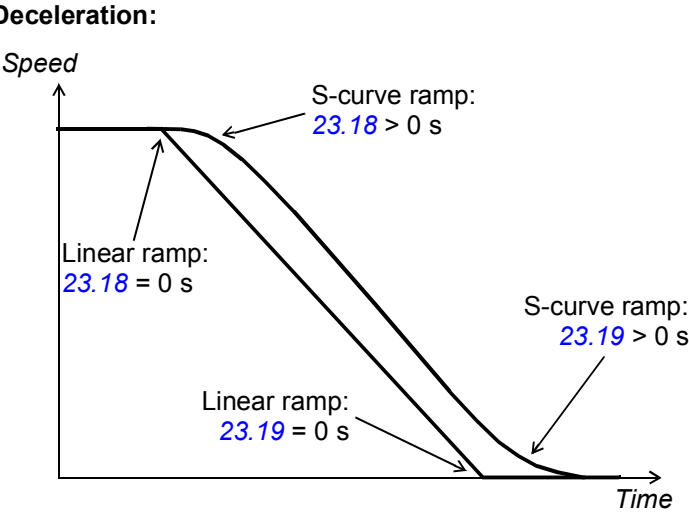

No.	Name/Value	Description	Def/FbEq16
23.16	<i>Shape time acc 1</i>	<p>Defines the shape of the acceleration ramp at the beginning of the acceleration.</p> <p>0.000 s: Linear ramp. Suitable for steady acceleration or deceleration and for slow ramps.</p> <p>0.001...1000.000 s: S-curve ramp. S-curve ramps are ideal for lifting applications. The S-curve consists of symmetrical curves at both ends of the ramp and a linear part in between.</p> <p><b>Acceleration:</b></p>  <p><b>Deceleration:</b></p> 	0.0 s
0.000 ...1800.000 s		Ramp shape at start of acceleration.	10 = 1 s
23.17	<i>Shape time acc 2</i>	<p>Defines the shape of the acceleration ramp at the end of the acceleration. See parameter <a href="#">23.16 Shape time acc 1</a>.</p>	0.000 s
0.000 ...1800.000 s		Ramp shape at end of acceleration.	10 = 1 s
23.18	<i>Shape time dec 1</i>	<p>Defines the shape of the deceleration ramp at the beginning of the deceleration. See parameter <a href="#">23.16 Shape time acc 1</a>.</p>	0.000 s
0.000 ...1800.000 s		Ramp shape at start of deceleration.	10 = 1 s
23.19	<i>Shape time dec 2</i>	<p>Defines the shape of the deceleration ramp at the end of the deceleration. See parameter <a href="#">23.16 Shape time acc 1</a>.</p>	0.000 s
0.000 ...1800.000 s		Ramp shape at end of deceleration.	10 = 1 s

## 154 Parameters

No.	Name/Value	Description	Def/FbEq16
23.20	<i>Acc time jogging</i>	Defines the acceleration time for the jogging function i.e. the time required for the speed to change from zero to the speed value defined by parameter <a href="#">46.01 Speed scaling</a> . See section <a href="#">Jogging</a> (page 38).	60.000 s
	0.000 ... 1800.000 s	Acceleration time for jogging.	10 = 1 s
23.21	<i>Dec time jogging</i>	Defines the deceleration time for the jogging function i.e. the time required for the speed to change from the speed value defined by parameter <a href="#">46.01 Speed scaling</a> to zero. See section <a href="#">Jogging</a> (page 38).	60.000 s
	0.000 ... 1800.000 s	Deceleration time for jogging.	10 = 1 s
23.23	<i>Emergency stop time</i>	Defines the time inside which the drive is stopped if an emergency stop Off3 is activated (i.e. the time required for the speed to change from the speed value defined by parameter <a href="#">46.01 Speed scaling</a> to zero). Emergency stop mode and activation source are selected by parameters <a href="#">21.04 Emergency stop mode</a> and <a href="#">21.05 Emergency stop source</a> respectively. Emergency stop can also be activated through fieldbus. <b>Note:</b> Emergency stop Off1 uses the standard deceleration ramp as defined by parameters <a href="#">23.11...23.19</a> .	3.000 s
	0.000 ... 1800.000 s	Emergency stop Off3 deceleration time.	10 = 1 s
23.24	<i>Ramp in zero</i>	Selects a source that forces the speed reference to zero. 0 = Force speed reference to zero 1 = Normal operation	<i>Inactive</i>
	Active	0.	0
	Inactive	1.	1
	DI1	Digital input DI1 ( <a href="#">10.02 DI delayed status</a> , bit 0).	2
	DI2	Digital input DI2 ( <a href="#">10.02 DI delayed status</a> , bit 1).	3
	DI3	Digital input DI3 ( <a href="#">10.02 DI delayed status</a> , bit 2).	4
	DI4	Digital input DI4 ( <a href="#">10.02 DI delayed status</a> , bit 3).	5
	DI5	Digital input DI5 ( <a href="#">10.02 DI delayed status</a> , bit 4).	6
	DI6	Digital input DI6 ( <a href="#">10.02 DI delayed status</a> , bit 5).	7
	DIO1	Digital input/output DIO1 ( <a href="#">11.02 DIO delayed status</a> , bit 0).	10
	DIO2	Digital input/output DIO2 ( <a href="#">11.02 DIO delayed status</a> , bit 1).	11
	<i>Other [bit]</i>	Source selection (see <a href="#">Terms and abbreviations</a> on page 81).	-
23.26	<i>Ramp out balance enable</i>	Selects the source for enabling/disabling speed reference ramp balancing. See parameter <a href="#">23.27 Ramp out balance ref</a> . 0 = Disabled 1 = Enabled	<i>Off</i>
	Off	0.	0
	On	1.	1
	DI1	Digital input DI1 ( <a href="#">10.02 DI delayed status</a> , bit 0).	2
	DI2	Digital input DI2 ( <a href="#">10.02 DI delayed status</a> , bit 1).	3
	DI3	Digital input DI3 ( <a href="#">10.02 DI delayed status</a> , bit 2).	4
	DI4	Digital input DI4 ( <a href="#">10.02 DI delayed status</a> , bit 3).	5
	DI5	Digital input DI5 ( <a href="#">10.02 DI delayed status</a> , bit 4).	6
	DI6	Digital input DI6 ( <a href="#">10.02 DI delayed status</a> , bit 5).	7

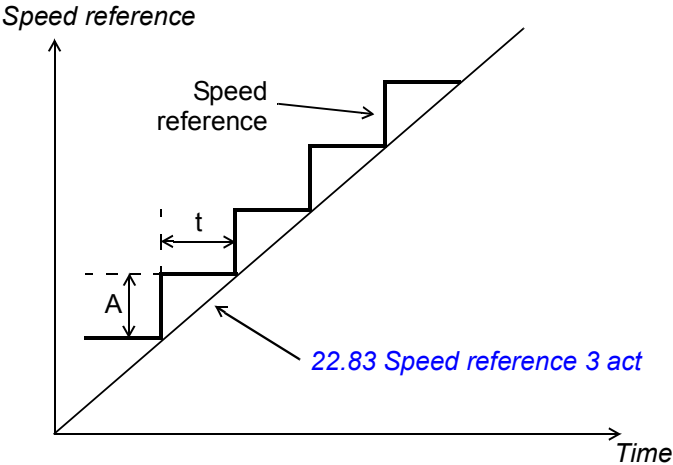
No.	Name/Value	Description	Def/FbEq16
	DIO1	Digital input/output DIO1 ( <a href="#">11.02 DIO delayed status</a> , bit 0).	10
	DIO2	Digital input/output DIO2 ( <a href="#">11.02 DIO delayed status</a> , bit 1).	11
	<i>Other [bit]</i>	Source selection (see <a href="#">Terms and abbreviations</a> on page 81).	-
<a href="#">23.27</a>	<a href="#">Ramp out balance ref</a>	Defines the reference for speed ramp balancing. The output of the ramp generator is forced to this value when balancing is enabled by parameter <a href="#">23.26 Ramp out balance enable</a> .	0.00 rpm
	-30000.00 ... 30000.00 rpm	Speed ramp balancing reference.	See par. <a href="#">46.01</a>
<a href="#">23.28</a>	<a href="#">Variable slope enable</a>	<p>Activates the variable slope function, which controls the slope of the speed ramp during a speed reference change.</p> <p>If the update interval of the signal from an external control system and the variable slope rate (<a href="#">23.29 Variable slope rate</a>) are equal, speed reference 3 (<a href="#">22.83 Speed reference 3 act</a>) is a straight line.</p>  <p><math>t</math> = update interval of signal from external control system <math>A</math> = speed reference change during <math>t</math></p> <p>This function is only active in remote control.</p>	<i>Off</i>
	Off	Variable slope disabled.	0
	On	Variable slope enabled (not available in local control).	1
<a href="#">23.29</a>	<a href="#">Variable slope rate</a>	Defines the rate of the speed reference change when variable slope is enabled by parameter <a href="#">23.28 Variable slope enable</a> . For the best result, enter the reference update interval into this parameter.	50 ms
	2...30000 ms	Variable slope rate.	1 = 1 ms
<a href="#">24 Speed reference conditioning</a>		Speed error calculation; speed error window control configuration; speed error step. See the control chain diagrams on pages <a href="#">352</a> and <a href="#">353</a> .	
<a href="#">24.01</a>	<a href="#">Used speed reference</a>	Displays the ramped and corrected speed reference (before speed error calculation). See the control chain diagram on page <a href="#">352</a> . This parameter is read-only.	-
	-30000.00 ... 30000.00 rpm	Speed reference used for speed error calculation.	See par. <a href="#">46.01</a>

No.	Name/Value	Description	Def/FbEq16
24.02	<i>Used actual speed</i>	Displays the speed feedback used for speed error calculation. See the control chain diagram on page 352. This parameter is read-only.	-
	-30000.00 ... 30000.00 rpm	Speed feedback used for speed error calculation.	See par. 46.01
24.03	<i>Speed error filtered</i>	Displays the filtered speed error. See the control chain diagram on page 352. This parameter is read-only.	-
	-30000.0 ... 30000.0 rpm	Filtered speed error.	See par. 46.01
24.04	<i>Speed error negative</i>	Displays the inverted (unfiltered) speed error. See the control chain diagram on page 352. This parameter is read-only.	-
	-30000.0 ... 30000.0 rpm	Inverted speed error.	See par. 46.01
24.11	<i>Speed correction</i>	Defines a speed reference correction. This value is added to the existing reference between ramping and limitation. See the control chain diagram on page 352.	0
	-10000...10000	Speed reference correction.	See par. 46.01
24.12	<i>Speed error filter time</i>	Defines the time constant of the speed error low-pass filter. If the used speed reference changes rapidly, the possible interferences in the speed measurement can be filtered with the speed error filter. Reducing the ripple with filter may cause speed controller tuning problems. A long filter time constant and fast acceleration time contradict one another. A very long filter time results in unstable control.	0 ms
	0...10000 ms	Speed error filtering time constant. 0 = filtering disabled.	1 = 1 ms

No.	Name/Value	Description	Def/FbEq16
24.41	<i>Speed error window control enable</i>	<p>Enables or disables speed error window control.</p> <p>Speed error window control forms a speed supervision function for a torque-controlled drive. It supervises the speed error value (speed reference – actual speed). In the normal operating range, window control keeps the speed controller input at zero. The speed controller is evoked only if the speed error exits the speed error window.</p> <p>When the speed error moves outside the window, the exceeding part of the error value is connected to the speed controller. The speed controller produces a reference term relative to the input and gain of the speed controller (parameter <a href="#">25.02 Proportional gain</a>) which the torque selector adds to the torque reference. The result is used as the internal torque reference for the drive.</p> <p>The window boundaries are defined by parameters <a href="#">24.43 Speed error window high</a> and <a href="#">24.44 Speed error window low</a> as follows:</p> <div data-bbox="608 792 1188 1397" style="text-align: center;"> </div>	<i>Disable</i>
	Disable	Speed error window control inactive.	0
	Enable	Speed error window control active.	1
24.43	<i>Speed error window high</i>	Defines the upper boundary of the speed error window. See parameter <a href="#">24.41 Speed error window control enable</a> .	0 rpm
	0 ... 3000 rpm	Upper boundary of speed error window.	See par. <a href="#">46.01</a>

No.	Name/Value	Description	Def/FbEq16
24.44	<i>Speed error window low</i>	Defines the lower boundary of the speed error window. See parameter <a href="#">24.41 Speed error window control enable</a> .	0 rpm
	0 ... 3000 rpm	Lower boundary of speed error window.	See par. <a href="#">46.01</a>
24.46	<i>Speed error step</i>	Defines an additional speed step given to the input of the speed controller (and added to the speed error value).	0.0 rpm
	-3000.0 ... 3000.0 rpm	Speed error step.	See par. <a href="#">46.01</a>

<b>25 Speed control</b>		Speed controller settings. See the control chain diagrams on pages <a href="#">352</a> and <a href="#">353</a> .	
25.01	<i>Torque reference speed control</i>	Displays the speed controller output that is transferred to the torque controller. See the control chain diagram on page <a href="#">353</a> . This parameter is read-only.	-
	-1600.0 ... 1600.0%	Limited speed controller output torque.	See par. <a href="#">46.03</a>
25.02	<i>Proportional gain</i>	Defines the proportional gain ( $K_p$ ) of the speed controller. Too high a gain may cause speed oscillation. The figure below shows the speed controller output after an error step when the error remains constant.	10.00
		<p>Gain = <math>K_p = 1</math>  <math>T_i</math> = Integration time = 0  <math>T_D</math> = Derivation time = 0</p> <p>Controller output = <math>K_p \times e</math></p> <p>e = Error value</p>	
	0.00 ... 250.00	If gain is set to 1, a 10% change in error value (reference - actual value) causes the speed controller output to change by 10%.	
		Proportional gain for speed controller.	100 = 1

No.	Name/Value	Description	Def/FbEq16
25.03	<i>Integration time</i>	<p>Defines the integration time of the speed controller. The integration time defines the rate at which the controller output changes when the error value is constant and the proportional gain of the speed controller is 1. The shorter the integration time, the faster the continuous error value is corrected. Too short an integration time makes the control unstable.</p> <p>If parameter value is set to zero, the I-part of the controller is disabled.</p> <p>Anti-windup stops the integrator if the controller output is limited.</p> <p>The figure below shows the speed controller output after an error step when the error remains constant.</p>	2.50 s
0.00 ... 1000.00 s	Integration time for speed controller.	10 = 1 s	

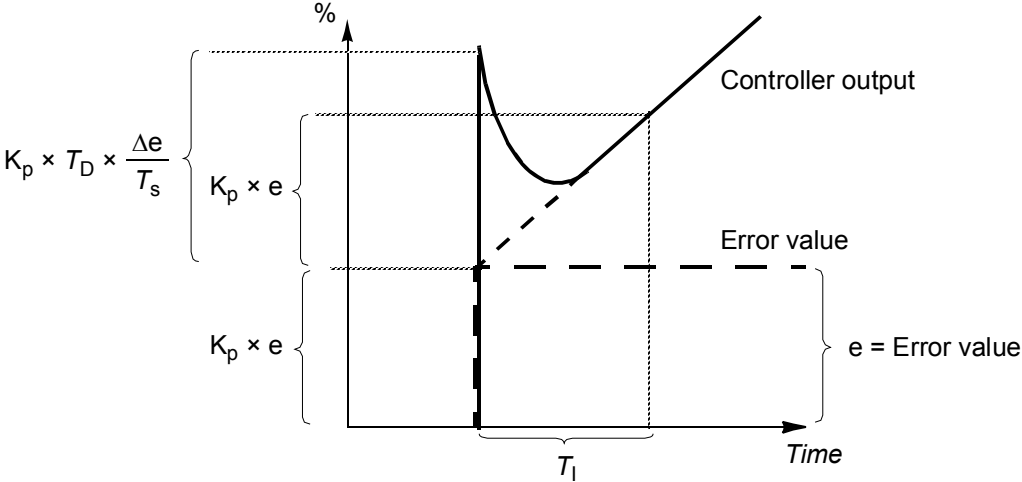
No.	Name/Value	Description	Def/FbEq16
25.04	<i>Derivation time</i>	<p>Defines the derivation time of the speed controller. Derivative action boosts the controller output if the error value changes. The longer the derivation time, the more the speed controller output is boosted during the change. If the derivation time is set to zero, the controller works as a PI controller, otherwise as a PID controller. The derivation makes the control more responsive for disturbances.</p> <p>The speed error derivative must be filtered with a low pass filter to eliminate disturbances.</p> <p>The figure below shows the speed controller output after an error step when the error remains constant.</p>	0.000 s
 <p>Gain = <math>K_p = 1</math>  <math>T_I</math> = Integration time &gt; 0  <math>T_D</math> = Derivation time &gt; 0  <math>T_s</math> = Sample time period = 250 <math>\mu</math>s  <math>\Delta e</math> = Error value change between two samples</p>			
		<b>Note:</b> Changing this parameter value is recommended only if a pulse encoder is used.	
	0.000 ... 10000.000 s	Derivation time for speed controller.	1000 = 1 s
25.05	<i>Derivation filter time</i>	Defines the derivation filter time constant. See parameter <a href="#">25.04 Derivation time</a> .	8.0 ms
	0.0 ... 1000.0 ms	Derivation filter time constant.	1 = 1 ms

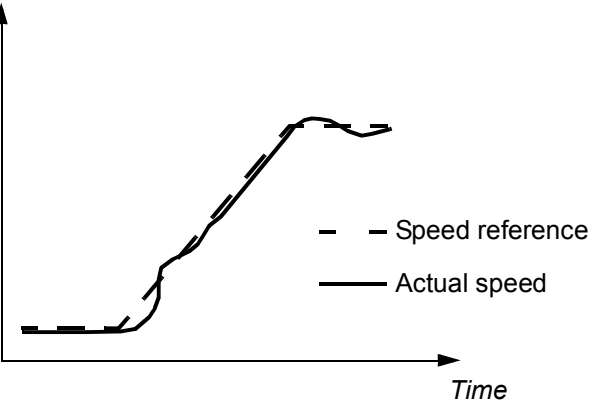
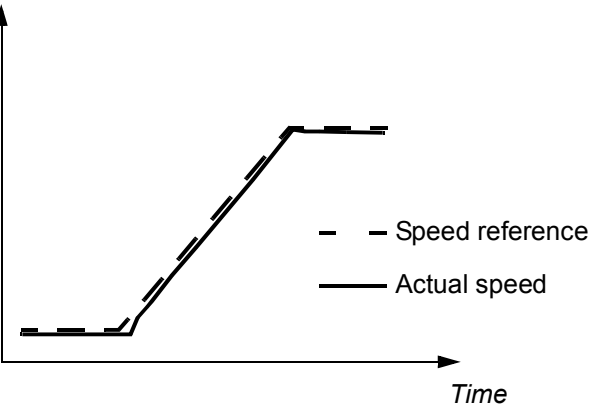

No.	Name/Value	Description	Def/FbEq16
25.06	<i>Acc comp derivation time</i>	<p>Defines the derivation time for acceleration(/deceleration) compensation. In order to compensate inertia during acceleration, a derivative of the reference is added to the output of the speed controller. The principle of a derivative action is described under parameter <a href="#">25.04 Derivation time</a>.</p> <p><b>Note:</b> As a general rule, set this parameter to the value between 50 and 100% of the sum of the mechanical time constants of the motor and the driven machine.</p> <p>The figure below shows the speed responses when a high inertia load is accelerated along a ramp.</p> <p><b>No acceleration compensation:</b></p>  <p><b>Acceleration compensation:</b></p> 	0.00 s
0.00 ... 1000.00 s		Acceleration compensation derivation time.	10 = 1 s
25.07	<i>Acc comp filter time</i>	<p>Defines the acceleration (or deceleration) compensation filter time constant.. See parameters <a href="#">25.04 Derivation time</a> and <a href="#">25.06 Acc comp derivation time</a>.</p>	8.0 ms
0.0 ... 1000.0 ms		Acceleration/deceleration compensation filter time.	1 = 1 ms

No.	Name/Value	Description	Def/FbEq16
25.08	<i>Drooping rate</i>	<p>Defines the droop rate in percent of the nominal motor speed. Drooping decreases the drive speed slightly as the drive load increases. The actual speed decrease at a certain operating point depends on the droop rate setting and the drive load (= torque reference / speed controller output). At 100% speed controller output, drooping is at its nominal level, i.e. equal to the value of this parameter. The drooping effect decreases linearly to zero along with the decreasing load.</p> <p>The droop rate can be used e.g. to adjust the load sharing in a Master/Follower application run by several drives. In a Master/Follower application the motor shafts are coupled to each other.</p> <p>The correct droop rate for a process must be found out case by case in practice.</p>	0.00%

**Speed decrease** = Speed controller output × Drooping × Nominal speed

**Example:** Speed controller output is 50%, droop rate is 1%, nominal speed of the drive is 1500 rpm.

Speed decrease = 0.50 × 0.01 × 1500 rpm = 7.5 rpm.

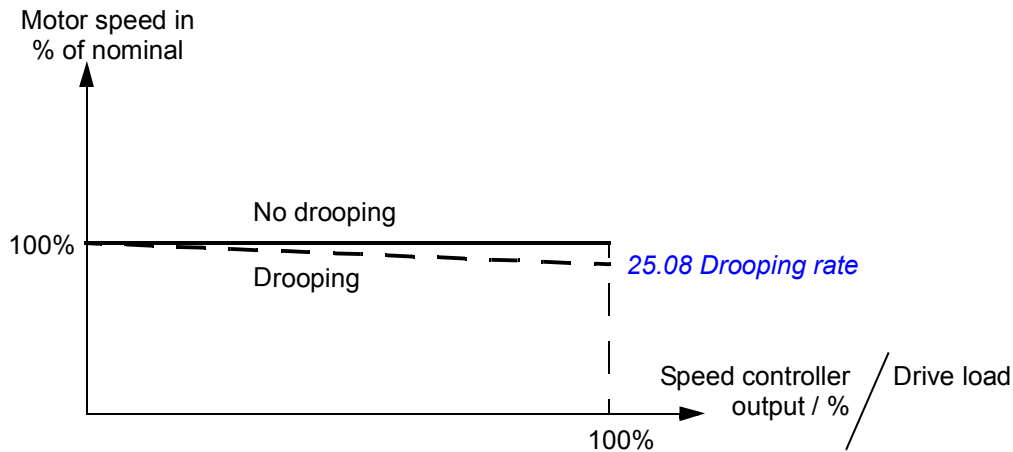

0.00 ... 100.00%	Droop rate.	100 = 1%	
25.09	<i>Speed ctrl balance enable</i>	<p>Selects the source for enabling/disabling speed controller output balancing. See parameter <a href="#">25.10 Speed ctrl balance reference</a>.</p> <p>0 = Disabled 1 = Enabled</p>	<i>Off</i>
Off	0.	1	
On	1.	2	
DI1	Digital input DI1 ( <a href="#">10.02 DI delayed status</a> , bit 0).	2	
DI2	Digital input DI2 ( <a href="#">10.02 DI delayed status</a> , bit 1).	3	
DI3	Digital input DI3 ( <a href="#">10.02 DI delayed status</a> , bit 2).	4	
DI4	Digital input DI4 ( <a href="#">10.02 DI delayed status</a> , bit 3).	5	
DI5	Digital input DI5 ( <a href="#">10.02 DI delayed status</a> , bit 4).	6	
DI6	Digital input DI6 ( <a href="#">10.02 DI delayed status</a> , bit 5).	7	
DIO1	Digital input/output DIO1 ( <a href="#">11.02 DIO delayed status</a> , bit 0).	10	
DIO2	Digital input/output DIO2 ( <a href="#">11.02 DIO delayed status</a> , bit 1).	11	
<i>Other [bit]</i>	Source selection (see <a href="#">Terms and abbreviations</a> on page 81).	-	

No.	Name/Value	Description	Def/FbEq16
25.10	<i>Speed ctrl balance reference</i>	Defines the reference used in speed controller output balancing. The output of the speed controller is forced to this value when balancing is enabled by parameter <a href="#">25.09 Speed ctrl balance enable</a> . In order to guarantee smooth operation during output balancing, the D-part of the speed controller is disabled and the acceleration compensation term is set to zero.	0
	-300 ... 300	Speed control output balancing reference.	1 = 1
25.11	<i>Min torque speed control</i>	Defines the minimum speed controller output torque.	-300.0%
	-1600.0 ... 0.0%	Minimum speed controller output torque.	See par. <a href="#">46.03</a>
25.12	<i>Max torque speed control</i>	Defines the maximum speed controller output torque.	300.0%
	0.0 ... 1600.0%	Maximum speed controller output torque.	See par. <a href="#">46.03</a>
25.15	<i>Proportional gain em stop</i>	Defines the proportional gain for the speed controller when an emergency stop is active. See parameter <a href="#">25.02 Proportional gain</a> .	10.00
	0.00 ... 250.00	Proportional gain upon an emergency stop.	100 = 1
25.53	<i>Torque prop reference</i>	Displays the output of the proportional (P) part of the speed controller. See the control chain diagram on page <a href="#">353</a> . This parameter is read-only.	-
	-30000.0 ... 30000.0%	P-part output of speed controller.	See par. <a href="#">46.03</a>
25.54	<i>Torque integ reference</i>	Displays the output of the integral (I) part of the speed controller. See the control chain diagram on page <a href="#">353</a> . This parameter is read-only.	-
	-30000.0 ... 30000.0%	I-part output of speed controller.	See par. <a href="#">46.03</a>
25.55	<i>Torque der reference</i>	Displays the output of the derivative (D) part of the speed controller. See the control chain diagram on page <a href="#">353</a> . This parameter is read-only.	-
	-30000.0 ... 30000.0%	D-part output of speed controller.	See par. <a href="#">46.03</a>
25.56	<i>Torque acc compensation</i>	Displays the output of the acceleration compensation function. See the control chain diagram on page <a href="#">353</a> . This parameter is read-only.	-
	-30000.0 ... 30000.0%	Output of acceleration compensation function.	See par. <a href="#">46.03</a>
25.57	<i>Torque reference unbalanced</i>	Displays the acceleration-compensated output of the speed controller. See the control chain diagram on page <a href="#">353</a> . This parameter is read-only.	-
	-30000.0 ... 30000.0%	Acceleration-compensated output of speed controller.	See par. <a href="#">46.03</a>

## 164 Parameters

No.	Name/Value	Description	Def/FbEq16
<b>26 Torque reference chain</b>		Settings of the torque reference chain. See the control chain diagrams on pages <a href="#">354</a> and <a href="#">356</a> .	
<b>26.01 Torque ref to TC</b>		Displays the torque reference given to the torque controller in percent. See the control chain diagram on page <a href="#">356</a> . This parameter is read-only.	-
	-1600.0 ... 1600.0%	Torque reference for torque control.	See par. <a href="#">46.03</a>
<b>26.02 Torque ref used</b>		Displays the torque reference after frequency, voltage and torque limitation in percent of motor nominal torque. See the control chain diagram on page <a href="#">357</a> . This parameter is read-only.	-
	-1600.0 ... 1600.0%	Torque reference for torque control.	See par. <a href="#">46.03</a>
<b>26.08 Minimum torque ref</b>		Defines the minimum torque reference.	-300.0%
	-1000.0 ... 0.0%	Minimum torque reference.	See par. <a href="#">46.03</a>
<b>26.09 Maximum torque ref</b>		Defines the maximum torque reference.	300.0%
	0.0 ... 1000.0%	Maximum torque reference.	See par. <a href="#">46.03</a>
<b>26.11 Torque ref1 selection</b>		Selects torque reference source 1. See also parameter <a href="#">26.13 Torque ref1 function</a> .	<b>Zero</b>
	Zero	None.	0
	AI1 scaled	<a href="#">12.12 AI1 scaled value</a> (see page <a href="#">102</a> ).	1
	AI2 scaled	<a href="#">12.22 AI2 scaled value</a> (see page <a href="#">103</a> ).	2
	FB A ref1	<a href="#">03.05 FB A reference 1</a> (see page <a href="#">85</a> ).	4
	FB A ref2	<a href="#">03.06 FB A reference 2</a> (see page <a href="#">85</a> ).	5
	DDCS ctrl ref1	<a href="#">03.11 DDCS controller ref 1</a> (see page <a href="#">85</a> ).	9
	DDCS ctrl ref2	<a href="#">03.12 DDCS controller ref 2</a> (see page <a href="#">86</a> ).	10
	D2D or M/F reference 1	<a href="#">03.13 M/F or D2D ref1</a> (see page <a href="#">86</a> ).	11
	D2D or M/F reference 2	<a href="#">03.14 M/F or D2D ref2</a> (see page <a href="#">86</a> ).	12
	PID	<a href="#">40.01 Process PID actual value</a> (output of the process PID controller).	15
	Other	The value is taken from another parameter.	-
<b>26.12 Torque ref2 selection</b>		Selects torque reference source 2. See also parameter <a href="#">26.13 Torque ref1 function</a> . For the available selections, see parameter <a href="#">26.11 Torque ref1 selection</a> .	<b>Zero</b>
<b>26.13 Torque ref1 function</b>		Selects a mathematical function between the reference sources selected by parameters <a href="#">26.11 Torque ref1 selection</a> and <a href="#">26.12 Torque ref2 selection</a> . The result of the function is then selectable as torque reference 1 in parameter <a href="#">26.14 Torque ref1/2 selection</a> .	<b>Ref 1</b>
	Ref 1	Signal selected by <a href="#">26.11 Torque ref1 selection</a> is used as torque reference 1 as such.	0
	Add	The sum of the reference sources is used as torque reference 1.	1

No.	Name/Value	Description	Def/FbEq16
	Sub	The subtraction ([ <a href="#">26.11 Torque ref1 selection</a> ] - [ <a href="#">26.12 Torque ref2 selection</a> ]) of the reference sources is used as torque reference 1.	2
	Mul	The multiplication of the reference sources is used as torque reference 1.	3
	Min	The smaller of the reference sources is used as torque reference 1.	4
	Max	The greater of the reference sources is used as torque reference 1.	5
<a href="#">26.14</a>	<a href="#">Torque ref1/2 selection</a>	Configures the selection between torque references 1 and 2. (The sources of the references are defined by parameters <a href="#">26.11 Torque ref1 selection</a> and <a href="#">26.12 Torque ref2 selection</a> respectively.) 0 = Torque reference 1 1 = Torque reference 2	<a href="#">Torque reference 1</a>
	Torque reference 1	0.	0
	Torque reference 2	1.	1
	<a href="#">Other [bit]</a>	Source selection (see <a href="#">Terms and abbreviations</a> on page 81).	-
<a href="#">26.15</a>	<a href="#">Load share</a>	Defines the scaling factor for the torque reference (the torque reference is multiplied by the value).	1.000
	-8.000 ... 8.000	Torque reference scaling factor.	1000 = 1
<a href="#">26.16</a>	<a href="#">Torque additive 1 source</a>	Selects the source for torque reference additive 1. <b>Note:</b> For safety reasons, the additive is not applied when an emergency stop is active. See the control chain diagram on page 354.	<a href="#">Zero</a>
	Zero	None.	0
	AI1 scaled	<a href="#">12.12 AI1 scaled value</a> (see page 102).	1
	AI2 scaled	<a href="#">12.22 AI2 scaled value</a> (see page 103).	2
	FB A ref1	<a href="#">03.05 FB A reference 1</a> (see page 85).	4
	FB A ref2	<a href="#">03.06 FB A reference 2</a> (see page 85).	5
	DDCS ctrl ref1	<a href="#">03.11 DDCS controller ref 1</a> (see page 85).	9
	DDCS ctrl ref2	<a href="#">03.12 DDCS controller ref 2</a> (see page 86).	10
	D2D or M/F reference 1	<a href="#">03.13 M/F or D2D ref1</a> (see page 86).	11
	D2D or M/F reference 2	<a href="#">03.14 M/F or D2D ref2</a> (see page 86).	12
	PID	<a href="#">40.01 Process PID actual value</a> (output of the process PID controller).	15
	Other	The value is taken from another parameter.	-
<a href="#">26.17</a>	<a href="#">Torque ref filter time</a>	Defines a low-pass filter time constant for the torque reference.	0.000 s
	0.000 ... 30.000 s	Filter time constant for torque reference.	1000 = 1 s
<a href="#">26.18</a>	<a href="#">Torque ramp up time</a>	Defines the torque reference ramp-up time, ie. the time for the reference to increase from zero to nominal motor torque.	0.000 s
	0.000 ... 60.000 s	Torque reference ramp-up time.	100 = 1 s

No.	Name/Value	Description	Def/FbEq16
26.19	<i>Torque ramp down time</i>	Defines the torque reference ramp-down time, ie. the time for the reference to decrease from nominal motor torque to zero.	0.000 s
	0.000 ... 60.000 s	Torque reference ramp-down time.	100 = 1 s
26.25	<i>Torque additive 2 source</i>	Selects the source of torque reference additive 2. The value received from the selected source is added to the torque reference after operating mode selection. Because of this, the additive can be used in speed and torque modes. <b>Note:</b> For safety reasons, the additive is not applied when an emergency stop is active. See the control chain diagram on page 356.	<i>Zero</i>
	Zero	None.	0
	AI1 scaled	<a href="#">12.12 AI1 scaled value</a> (see page 102).	1
	AI2 scaled	<a href="#">12.22 AI2 scaled value</a> (see page 103).	2
	FB A ref1	<a href="#">03.05 FB A reference 1</a> (see page 85).	4
	FB A ref2	<a href="#">03.06 FB A reference 2</a> (see page 85).	5
	DDCS ctrl ref1	<a href="#">03.11 DDCS controller ref 1</a> (see page 85).	9
	DDCS ctrl ref2	<a href="#">03.12 DDCS controller ref 2</a> (see page 86).	10
	D2D or M/F reference 1	<a href="#">03.13 M/F or D2D ref1</a> (see page 86).	11
	D2D or M/F reference 2	<a href="#">03.14 M/F or D2D ref2</a> (see page 86).	12
	PID	<a href="#">40.01 Process PID actual value</a> (output of the process PID controller).	15
	Other	The value is taken from another parameter.	-
26.26	<i>Force torque ref add 2 zero</i>	Selects a source that forces torque reference additive 2 (see parameter <a href="#">26.25 Torque additive 2 source</a> ) to zero. 0 = Normal operation 1 = Force torque reference additive 2 to zero.	<i>Off</i>
	Off	0.	0
	On	1.	1
	DI1	Digital input DI1 ( <a href="#">10.02 DI delayed status</a> , bit 0).	2
	DI2	Digital input DI2 ( <a href="#">10.02 DI delayed status</a> , bit 1).	3
	DI3	Digital input DI3 ( <a href="#">10.02 DI delayed status</a> , bit 2).	4
	DI4	Digital input DI4 ( <a href="#">10.02 DI delayed status</a> , bit 3).	5
	DI5	Digital input DI5 ( <a href="#">10.02 DI delayed status</a> , bit 4).	6
	DI6	Digital input DI6 ( <a href="#">10.02 DI delayed status</a> , bit 5).	7
	DIO1	Digital input/output DIO1 ( <a href="#">11.02 DIO delayed status</a> , bit 0).	10
	DIO2	Digital input/output DIO2 ( <a href="#">11.02 DIO delayed status</a> , bit 1).	11
	<i>Other [bit]</i>	Source selection (see <a href="#">Terms and abbreviations</a> on page 81).	-
26.41	<i>Torque step</i>	When enabled by parameter <a href="#">26.42 Torque step enable</a> , adds an additional step to the torque reference.	0.00%
	-300.00 ... 300.00%	Torque step.	See par. <a href="#">46.03</a>
26.42	<i>Torque step enable</i>	Enables a torque step (defined by parameter <a href="#">26.41 Torque step</a> ).	<i>Disable</i>
	Disable	Torque step disabled.	0

No.	Name/Value	Description	Def/FbEq16
	Enable	Torque step enabled.	1
26.70	<i>Torque ref1 actual</i>	Displays the value of torque reference source 1 (selected by parameter <a href="#">26.11 Torque ref1 selection</a> ). See the control chain diagram on page <a href="#">354</a> . This parameter is read-only.	-
	-1600.0 ... 1600.0%	Value of torque reference source 1.	See par. <a href="#">46.03</a>
26.71	<i>Torque ref2 actual</i>	Displays the value of torque reference source 2 (selected by parameter <a href="#">26.12 Torque ref2 selection</a> ). See the control chain diagram on page <a href="#">354</a> . This parameter is read-only.	-
	-1600.0 ... 1600.0%	Value of torque reference source 2.	See par. <a href="#">46.03</a>
26.72	<i>Torque ref3 actual</i>	Displays the torque reference after the function applied by parameter <a href="#">26.13 Torque ref1 function</a> (if any), and after selection ( <a href="#">26.14 Torque ref1/2 selection</a> ). See the control chain diagram on page <a href="#">354</a> . This parameter is read-only.	-
	-1600.0 ... 1600.0%	Torque reference after selection.	See par. <a href="#">46.03</a>
26.73	<i>Torque ref4 actual</i>	Displays the torque reference after application of reference additive 1. See the control chain diagram on page <a href="#">354</a> . This parameter is read-only.	-
	-1600.0 ... 1600.0%	Torque reference after application of reference additive 1.	See par. <a href="#">46.03</a>
26.74	<i>Torque ref ramp out</i>	Displays the torque reference after limiting and ramping. See the control chain diagram on page <a href="#">354</a> . This parameter is read-only.	-
	-1600.0 ... 1600.0%	Torque reference after limiting and ramping.	See par. <a href="#">46.03</a>
26.75	<i>Torque ref5 actual</i>	Displays the torque reference after control mode selection. See the control chain diagram on page <a href="#">356</a> . This parameter is read-only.	-
	-1600.0 ... 1600.0%	Torque reference after control mode selection.	See par. <a href="#">46.03</a>
26.76	<i>Torque ref6 actual</i>	Displays the torque reference after application of reference additive 2. See the control chain diagram on page <a href="#">356</a> . This parameter is read-only.	-
	-1600.0 ... 1600.0%	Torque reference after application of reference additive 2.	See par. <a href="#">46.03</a>
26.77	<i>Torque ref add A actual</i>	Displays the value of the source of torque reference additive 2. See the control chain diagram on page <a href="#">356</a> . This parameter is read-only.	-
	-1600.0 ... 1600.0%	Torque reference additive 2.	See par. <a href="#">46.03</a>
26.78	<i>Torque ref add B actual</i>	Displays the value of torque reference additive 2 before it is added to torque reference. See the control chain diagram on page <a href="#">356</a> . This parameter is read-only.	-
	-1600.0 ... 1600.0%	Torque reference additive 2.	See par. <a href="#">46.03</a>

No.	Name/Value	Description	Def/FbEq16
<a href="#">26.81</a>	<a href="#">Rush control gain</a>	Rush controller gain term.	10.0
	1.0 ... 10000.0	Rush controller gain.	1 = 1
<a href="#">26.82</a>	<a href="#">Rush control integration time</a>	Rush controller integration time term.	2.0 s
	0.1 ... 10.0 s	Rush controller integration time.	1 = 1 s
<b>28 Frequency reference chain</b>		Settings of the frequency reference chain. See the control chain diagrams on pages <a href="#">358</a> and <a href="#">359</a> .	
<a href="#">28.01</a>	<a href="#">Frequency ref ramp in</a>	Displays the used frequency reference before ramping. See the control chain diagram on page <a href="#">359</a> . This parameter is read-only.	-
	-500.00 ... 500.00 Hz	Frequency reference before ramping.	See par. <a href="#">46.02</a>
<a href="#">28.02</a>	<a href="#">Frequency ref ramp out</a>	Displays the final frequency reference (after selection, limitation and ramping). See the control chain diagram on page <a href="#">359</a> . This parameter is read-only.	-
	-500.00 ... 500.00 Hz	Final frequency reference.	See par. <a href="#">46.02</a>
<a href="#">28.11</a>	<a href="#">Frequency ref1 selection</a>	Selects frequency reference source 1. See also parameter <a href="#">28.13 Frequency ref1 function</a> .	<a href="#">AI1 scaled</a>
	Zero	None.	0
	AI1 scaled	<a href="#">12.12 AI1 scaled value</a> (see page <a href="#">102</a> ).	1
	AI2 scaled	<a href="#">12.22 AI2 scaled value</a> (see page <a href="#">103</a> ).	2
	FB A ref1	<a href="#">03.05 FB A reference 1</a> (see page <a href="#">85</a> ).	4
	FB A ref2	<a href="#">03.06 FB A reference 2</a> (see page <a href="#">85</a> ).	5
	DDCS ctrl ref1	<a href="#">03.11 DDCS controller ref 1</a> (see page <a href="#">85</a> ).	9
	DDCS ctrl ref2	<a href="#">03.12 DDCS controller ref 2</a> (see page <a href="#">86</a> ).	10
	D2D or M/F reference 1	<a href="#">03.13 M/F or D2D ref1</a> (see page <a href="#">86</a> ).	11
	D2D or M/F reference 2	<a href="#">03.14 M/F or D2D ref2</a> (see page <a href="#">86</a> ).	12
	PID	<a href="#">40.01 Process PID actual value</a> (output of the process PID controller).	15
	Other	The value is taken from another parameter.	-
<a href="#">28.12</a>	<a href="#">Frequency ref2 selection</a>	Selects frequency reference source 2. See also parameter <a href="#">28.13 Frequency ref1 function</a> . For the selections, see parameter <a href="#">28.11 Frequency ref1 selection</a> .	<a href="#">Zero</a>
<a href="#">28.13</a>	<a href="#">Frequency ref1 function</a>	Selects a mathematical function between the reference sources selected by parameters <a href="#">28.11 Frequency ref1 selection</a> and <a href="#">28.12 Frequency ref2 selection</a> . The result of the function is then selectable as frequency reference 1 in parameter <a href="#">28.14 Frequency ref1/2 selection</a> .	<a href="#">Ref1</a>
	Ref1	Signal selected by <a href="#">28.11 Frequency ref1 selection</a> is used as frequency reference 1 as such.	0
	Add	The sum of the reference sources is used as frequency reference 1.	1



No.	Name/Value	Description	Def/FbEq16									
	Sub	The subtraction ([ <a href="#">28.11 Frequency ref1 selection</a> ] - [ <a href="#">28.12 Frequency ref2 selection</a> ]) of the reference sources is used as frequency reference 1.	2									
	Mul	The multiplication of the reference sources is used as frequency reference 1.	3									
	Min	The smaller of the reference sources is used as frequency reference 1.	4									
	Max	The greater of the reference sources is used as frequency reference 1.	5									
<a href="#">28.14</a>	<a href="#">Frequency ref1/2 selection</a>	Configures the selection between frequency references 1 and 2. (The sources of the references are defined by parameters <a href="#">28.11 Frequency ref1 selection</a> and <a href="#">28.12 Frequency ref2 selection</a> respectively.) 0 = Frequency reference 1 1 = Frequency reference 2	<a href="#">Frequency reference 1</a>									
	Frequency reference 1	0.	0									
	Frequency reference 2	1.	1									
	<a href="#">Other [bit]</a>	Source selection (see <a href="#">Terms and abbreviations</a> on page 81).	-									
<a href="#">28.21</a>	<a href="#">Constant frequency function</a>	Determines how constant frequencies are selected, and whether the rotation direction signal is considered or not when applying a constant frequency.	00b									
		<table border="1"> <thead> <tr> <th>Bit</th> <th>Name</th> <th>Information</th> </tr> </thead> <tbody> <tr> <td>0</td> <td>Const freq mode</td> <td>1 = Packed: 7 constant frequencies are selectable using the three sources defined by parameters <a href="#">28.22</a>, <a href="#">28.23</a> and <a href="#">28.24</a>. 0 = Separate: Constant frequencies 1, 2 and 3 are separately activated by the sources defined by parameters <a href="#">28.22</a>, <a href="#">28.23</a> and <a href="#">28.24</a> respectively. In case of conflict, the constant frequency with the smaller number takes priority.</td> </tr> <tr> <td>1</td> <td>Dir ena</td> <td>1 = Start dir: To determine running direction for a constant frequency, the sign of the constant frequency setting (parameters <a href="#">28.26...28.32</a>) is multiplied by the direction signal (forward: +1, reverse: -1). For example, if the direction signal is reverse and the active constant frequency is negative, the drive will run in the forward direction. 0 = According to par: The running direction for the constant frequency is determined by the sign of the constant speed setting (parameters <a href="#">28.26...28.32</a>).</td> </tr> </tbody> </table>	Bit	Name	Information	0	Const freq mode	1 = Packed: 7 constant frequencies are selectable using the three sources defined by parameters <a href="#">28.22</a> , <a href="#">28.23</a> and <a href="#">28.24</a> . 0 = Separate: Constant frequencies 1, 2 and 3 are separately activated by the sources defined by parameters <a href="#">28.22</a> , <a href="#">28.23</a> and <a href="#">28.24</a> respectively. In case of conflict, the constant frequency with the smaller number takes priority.	1	Dir ena	1 = Start dir: To determine running direction for a constant frequency, the sign of the constant frequency setting (parameters <a href="#">28.26...28.32</a> ) is multiplied by the direction signal (forward: +1, reverse: -1). For example, if the direction signal is reverse and the active constant frequency is negative, the drive will run in the forward direction. 0 = According to par: The running direction for the constant frequency is determined by the sign of the constant speed setting (parameters <a href="#">28.26...28.32</a> ).	
Bit	Name	Information										
0	Const freq mode	1 = Packed: 7 constant frequencies are selectable using the three sources defined by parameters <a href="#">28.22</a> , <a href="#">28.23</a> and <a href="#">28.24</a> . 0 = Separate: Constant frequencies 1, 2 and 3 are separately activated by the sources defined by parameters <a href="#">28.22</a> , <a href="#">28.23</a> and <a href="#">28.24</a> respectively. In case of conflict, the constant frequency with the smaller number takes priority.										
1	Dir ena	1 = Start dir: To determine running direction for a constant frequency, the sign of the constant frequency setting (parameters <a href="#">28.26...28.32</a> ) is multiplied by the direction signal (forward: +1, reverse: -1). For example, if the direction signal is reverse and the active constant frequency is negative, the drive will run in the forward direction. 0 = According to par: The running direction for the constant frequency is determined by the sign of the constant speed setting (parameters <a href="#">28.26...28.32</a> ).										
	0000h...FFFFh	Constant speeds configuration word.	1 = 1									

No.	Name/Value	Description	Def/FbEq16																																				
28.22	<a href="#">Constant frequency sel1</a>	<p>When bit 0 of parameter <a href="#">28.21 Constant frequency function</a> is 0 (Separate), selects a source that activates constant frequency 1.</p> <p>When bit 0 of parameter <a href="#">28.21 Constant frequency function</a> is 1 (Packed), this parameter and parameters <a href="#">28.23 Constant frequency sel2</a> and <a href="#">28.24 Constant frequency sel3</a> select three sources whose states activate constant frequencies as follows:</p> <table border="1" data-bbox="315 539 1274 907"> <thead> <tr> <th>Source defined by par. <a href="#">28.22</a></th> <th>Source defined by par. <a href="#">28.23</a></th> <th>Source defined by par. <a href="#">28.24</a></th> <th>Constant frequency active</th> </tr> </thead> <tbody> <tr> <td>0</td> <td>0</td> <td>0</td> <td>None</td> </tr> <tr> <td>1</td> <td>0</td> <td>0</td> <td>Constant frequency 1</td> </tr> <tr> <td>0</td> <td>1</td> <td>0</td> <td>Constant frequency 2</td> </tr> <tr> <td>1</td> <td>1</td> <td>0</td> <td>Constant frequency 3</td> </tr> <tr> <td>0</td> <td>0</td> <td>1</td> <td>Constant frequency 4</td> </tr> <tr> <td>1</td> <td>0</td> <td>1</td> <td>Constant frequency 5</td> </tr> <tr> <td>0</td> <td>1</td> <td>1</td> <td>Constant frequency 6</td> </tr> <tr> <td>1</td> <td>1</td> <td>1</td> <td>Constant frequency 7</td> </tr> </tbody> </table>	Source defined by par. <a href="#">28.22</a>	Source defined by par. <a href="#">28.23</a>	Source defined by par. <a href="#">28.24</a>	Constant frequency active	0	0	0	None	1	0	0	Constant frequency 1	0	1	0	Constant frequency 2	1	1	0	Constant frequency 3	0	0	1	Constant frequency 4	1	0	1	Constant frequency 5	0	1	1	Constant frequency 6	1	1	1	Constant frequency 7	Off
Source defined by par. <a href="#">28.22</a>	Source defined by par. <a href="#">28.23</a>	Source defined by par. <a href="#">28.24</a>	Constant frequency active																																				
0	0	0	None																																				
1	0	0	Constant frequency 1																																				
0	1	0	Constant frequency 2																																				
1	1	0	Constant frequency 3																																				
0	0	1	Constant frequency 4																																				
1	0	1	Constant frequency 5																																				
0	1	1	Constant frequency 6																																				
1	1	1	Constant frequency 7																																				
	Off	0.	0																																				
	On	1.	1																																				
	DI1	Digital input DI1 ( <a href="#">10.02 DI delayed status</a> , bit 0).	2																																				
	DI2	Digital input DI2 ( <a href="#">10.02 DI delayed status</a> , bit 1).	3																																				
	DI3	Digital input DI3 ( <a href="#">10.02 DI delayed status</a> , bit 2).	4																																				
	DI4	Digital input DI4 ( <a href="#">10.02 DI delayed status</a> , bit 3).	5																																				
	DI5	Digital input DI5 ( <a href="#">10.02 DI delayed status</a> , bit 4).	6																																				
	DI6	Digital input DI6 ( <a href="#">10.02 DI delayed status</a> , bit 5).	7																																				
	DIO1	Digital input/output DIO1 ( <a href="#">11.02 DIO delayed status</a> , bit 0).	10																																				
	DIO2	Digital input/output DIO2 ( <a href="#">11.02 DIO delayed status</a> , bit 1).	11																																				
	<i>Other [bit]</i>	Source selection (see <a href="#">Terms and abbreviations</a> on page 81).	-																																				
28.23	<a href="#">Constant frequency sel2</a>	<p>When bit 0 of parameter <a href="#">28.21 Constant frequency function</a> is 0 (Separate), selects a source that activates constant frequency 2.</p> <p>When bit 0 of parameter <a href="#">28.21 Constant frequency function</a> is 1 (Packed), this parameter and parameters <a href="#">28.22 Constant frequency sel1</a> and <a href="#">28.24 Constant frequency sel3</a> select three sources that are used to activate constant frequencies. See table at parameter <a href="#">28.22 Constant frequency sel1</a>. For the selections, see parameter <a href="#">28.22 Constant frequency sel1</a>.</p>	Off																																				
28.24	<a href="#">Constant frequency sel3</a>	<p>When bit 0 of parameter <a href="#">28.21 Constant frequency function</a> is 0 (Separate), selects a source that activates constant frequency 3.</p> <p>When bit 0 of parameter <a href="#">28.21 Constant frequency function</a> is 1 (Packed), this parameter and parameters <a href="#">28.22 Constant frequency sel1</a> and <a href="#">28.23 Constant frequency sel2</a> select three sources that are used to activate constant frequencies. See table at parameter <a href="#">28.22 Constant frequency sel1</a>. For the selections, see parameter <a href="#">28.22 Constant frequency sel1</a>.</p>	Off																																				

No.	Name/Value	Description	Def/FbEq16											
28.26	<a href="#">Constant frequency 1</a>	Defines constant frequency 1.	0.00 Hz											
	-500.00 ... 500.00 Hz	Constant frequency 1.	See par. <a href="#">46.02</a>											
28.27	<a href="#">Constant frequency 2</a>	Defines constant frequency 2.	0.00 Hz											
	-500.00 ... 500.00 Hz	Constant frequency 2.	See par. <a href="#">46.02</a>											
28.28	<a href="#">Constant frequency 3</a>	Defines constant frequency 3.	0.00 Hz											
	-500.00 ... 500.00 Hz	Constant frequency 3.	See par. <a href="#">46.02</a>											
28.29	<a href="#">Constant frequency 4</a>	Defines constant frequency 4.	0.00 Hz											
	-500.00 ... 500.00 Hz	Constant frequency 4.	See par. <a href="#">46.02</a>											
28.30	<a href="#">Constant frequency 5</a>	Defines constant frequency 5.	0.00 Hz											
	-500.00 ... 500.00 Hz	Constant frequency 5.	See par. <a href="#">46.02</a>											
28.31	<a href="#">Constant frequency 6</a>	Defines constant frequency 6.	0.00 Hz											
	-500.00 ... 500.00 Hz	Constant frequency 6.	See par. <a href="#">46.02</a>											
28.32	<a href="#">Constant frequency 7</a>	Defines constant frequency 7.	0.00 Hz											
	-500.00 ... 500.00 Hz	Constant frequency 7.	See par. <a href="#">46.02</a>											
28.41	<a href="#">Frequency ref safe</a>	Defines a safe frequency reference that is used with supervision parameters such as <ul style="list-style-type: none"> <li>• <a href="#">49.05 Communication loss action</a></li> <li>• <a href="#">50.02 FBA A comm loss func.</a></li> </ul>	0.00 Hz											
	-500.00 ... 500.00 Hz	Safe frequency reference.	See par. <a href="#">46.02</a>											
28.51	<a href="#">Critical frequency function</a>	Enables/disables the critical frequencies function. Also determines whether the specified ranges are effective in both rotating directions or not. See also section <a href="#">Critical speeds (frequencies)</a> (page 36).	00b											
		<table border="1"> <thead> <tr> <th>Bit</th> <th>Name</th> <th>Information</th> </tr> </thead> <tbody> <tr> <td rowspan="2">0</td> <td rowspan="2">Crit freq</td> <td>1 = Enable: Critical frequencies enabled.</td> </tr> <tr> <td>0 = Disable: Critical frequencies disabled.</td> </tr> <tr> <td rowspan="2">1</td> <td rowspan="2">Sign mode</td> <td>1 = According to par: The signs of parameters <a href="#">28.52...28.57</a> are taken into account.</td> </tr> <tr> <td>0 = Absolute: Parameters <a href="#">28.52...28.57</a> are handled as absolute values. Each range is effective in both directions of rotation.</td> </tr> </tbody> </table>	Bit	Name	Information	0	Crit freq	1 = Enable: Critical frequencies enabled.	0 = Disable: Critical frequencies disabled.	1	Sign mode	1 = According to par: The signs of parameters <a href="#">28.52...28.57</a> are taken into account.	0 = Absolute: Parameters <a href="#">28.52...28.57</a> are handled as absolute values. Each range is effective in both directions of rotation.	
Bit	Name	Information												
0	Crit freq	1 = Enable: Critical frequencies enabled.												
		0 = Disable: Critical frequencies disabled.												
1	Sign mode	1 = According to par: The signs of parameters <a href="#">28.52...28.57</a> are taken into account.												
		0 = Absolute: Parameters <a href="#">28.52...28.57</a> are handled as absolute values. Each range is effective in both directions of rotation.												
	0000h...FFFFh	Critical frequencies configuration word.	1 = 1											

## 172 Parameters

No.	Name/Value	Description	Def/FbEq16
28.52	<i>Critical frequency 1 low</i>	Defines the low limit for critical frequency 1. <b>Note:</b> This value must be less than or equal to the value of <a href="#">28.53 Critical frequency 1 high</a> .	0.00 Hz
	-500.00 ... 500.00 Hz	Low limit for critical frequency 1.	See par. <a href="#">46.02</a>
28.53	<i>Critical frequency 1 high</i>	Defines the high limit for critical frequency 1. <b>Note:</b> This value must be greater than or equal to the value of <a href="#">28.52 Critical frequency 1 low</a> .	0.00 Hz
	-500.00 ... 500.00 Hz	High limit for critical frequency 1.	See par. <a href="#">46.02</a>
28.54	<i>Critical frequency 2 low</i>	Defines the low limit for critical frequency 2. <b>Note:</b> This value must be less than or equal to the value of <a href="#">28.55 Critical frequency 2 high</a> .	0.00 Hz
	-500.00 ... 500.00 Hz	Low limit for critical frequency 2.	See par. <a href="#">46.02</a>
28.55	<i>Critical frequency 2 high</i>	Defines the high limit for critical frequency 2. <b>Note:</b> This value must be greater than or equal to the value of <a href="#">28.54 Critical frequency 2 low</a> .	0.00 Hz
	-500.00 ... 500.00 Hz	High limit for critical frequency 2.	See par. <a href="#">46.02</a>
28.56	<i>Critical frequency 3 low</i>	Defines the low limit for critical frequency 3. <b>Note:</b> This value must be less than or equal to the value of <a href="#">28.57 Critical frequency 3 high</a> .	0.00 Hz
	-500.00 ... 500.00 Hz	Low limit for critical frequency 3.	See par. <a href="#">46.02</a>
28.57	<i>Critical frequency 3 high</i>	Defines the high limit for critical frequency 3. <b>Note:</b> This value must be greater than or equal to the value of <a href="#">28.56 Critical frequency 3 low</a> .	0.00 Hz
	-500.00 ... 500.00 Hz	High limit for critical frequency 3.	See par. <a href="#">46.02</a>
28.71	<i>Ramp set selection</i>	Selects a source that switches between the two sets of acceleration/deceleration times defined by parameters <a href="#">28.72...28.75</a> . 0 = Acceleration time 1 and deceleration time 1 are in force 1 = Acceleration time 2 and deceleration time 2 are in force	<i>Acc/Dec time 1</i>
	Acc/Dec time 1	0.	0
	Acc/Dec time 2	1.	1
	DI1	Digital input DI1 ( <a href="#">10.02 DI delayed status</a> , bit 0).	2
	DI2	Digital input DI2 ( <a href="#">10.02 DI delayed status</a> , bit 1).	3
	DI3	Digital input DI3 ( <a href="#">10.02 DI delayed status</a> , bit 2).	4
	DI4	Digital input DI4 ( <a href="#">10.02 DI delayed status</a> , bit 3).	5
	DI5	Digital input DI5 ( <a href="#">10.02 DI delayed status</a> , bit 4).	6
	DI6	Digital input DI6 ( <a href="#">10.02 DI delayed status</a> , bit 5).	7
	DIO1	Digital input/output DIO1 ( <a href="#">11.02 DIO delayed status</a> , bit 0).	10
	DIO2	Digital input/output DIO2 ( <a href="#">11.02 DIO delayed status</a> , bit 1).	11
	<i>Other [bit]</i>	Source selection (see <a href="#">Terms and abbreviations</a> on page 81).	-





No.	Name/Value	Description	Def/FbEq16
28.72	<i>Acceleration time 1</i>	Defines acceleration time 1 as the time required for the frequency to change from zero to the frequency defined by parameter <a href="#">46.02 Frequency scaling</a> . If the reference increases faster than the set acceleration rate, the motor will follow the acceleration rate. If the reference increases slower than the set acceleration rate, the motor frequency will follow the reference. If the acceleration time is set too short, the drive will automatically prolong the acceleration in order not to exceed the drive torque limits.	20.000 s
	0.000 ... 1800.000 s	Acceleration time 1.	10 = 1 s
28.73	<i>Deceleration time 1</i>	Defines deceleration time 1 as the time required for the frequency to change from the frequency defined by parameter <a href="#">46.02 Frequency scaling</a> to zero. If there is any doubt about the deceleration time being too short, ensure that DC overvoltage control ( <a href="#">30.30 Overvoltage control</a> ) is on. <b>Note:</b> If a short deceleration time is needed for a high inertia application, the drive should be equipped with braking equipment such as a brake chopper and brake resistor.	20.000 s
	0.000 ... 1800.000 s	Deceleration time 1.	10 = 1 s
28.74	<i>Acceleration time 2</i>	Defines acceleration time 2. See parameter <a href="#">28.72 Acceleration time 1</a> .	60.000 s
	0.000 ... 1800.000 s	Acceleration time 2.	10 = 1 s
28.75	<i>Deceleration time 2</i>	Defines deceleration time 2. See parameter <a href="#">28.73 Deceleration time 1</a> .	60.000 s
	0.000 ... 1800.000 s	Deceleration time 2.	10 = 1 s
28.76	<i>Ramp in zero</i>	Selects a source that forces the frequency reference to zero. 0 = Force frequency reference to zero 1 = Normal operation	<i>Inactive</i>
	Active	0.	0
	Inactive	1.	1
	DI1	Digital input DI1 ( <a href="#">10.02 DI delayed status</a> , bit 0).	2
	DI2	Digital input DI2 ( <a href="#">10.02 DI delayed status</a> , bit 1).	3
	DI3	Digital input DI3 ( <a href="#">10.02 DI delayed status</a> , bit 2).	4
	DI4	Digital input DI4 ( <a href="#">10.02 DI delayed status</a> , bit 3).	5
	DI5	Digital input DI5 ( <a href="#">10.02 DI delayed status</a> , bit 4).	6
	DI6	Digital input DI6 ( <a href="#">10.02 DI delayed status</a> , bit 5).	7
	DIO1	Digital input/output DIO1 ( <a href="#">11.02 DIO delayed status</a> , bit 0).	10
	DIO2	Digital input/output DIO2 ( <a href="#">11.02 DIO delayed status</a> , bit 1).	11
	<i>Other [bit]</i>	Source selection (see <a href="#">Terms and abbreviations</a> on page 81).	-
28.77	<i>Ramp hold</i>	Selects a source that forces the output of the frequency ramp generator to actual frequency value. 0 = Force ramp output to actual frequency 1 = Normal operation	<i>Inactive</i>
	Active	0.	0

## 174 Parameters

No.	Name/Value	Description	Def/FbEq16
	Inactive	1.	1
	DI1	Digital input DI1 ( <i>10.02 DI delayed status</i> , bit 0).	2
	DI2	Digital input DI2 ( <i>10.02 DI delayed status</i> , bit 1).	3
	DI3	Digital input DI3 ( <i>10.02 DI delayed status</i> , bit 2).	4
	DI4	Digital input DI4 ( <i>10.02 DI delayed status</i> , bit 3).	5
	DI5	Digital input DI5 ( <i>10.02 DI delayed status</i> , bit 4).	6
	DI6	Digital input DI6 ( <i>10.02 DI delayed status</i> , bit 5).	7
	DIO1	Digital input/output DIO1 ( <i>11.02 DIO delayed status</i> , bit 0).	10
	DIO2	Digital input/output DIO2 ( <i>11.02 DIO delayed status</i> , bit 1).	11
	<i>Other [bit]</i>	Source selection (see <i>Terms and abbreviations</i> on page 81).	-
<b>28.78</b>	<i>Ramp output balance</i>	Defines a reference for frequency ramp balancing. The output of the ramp generator is forced to this value when balancing is enabled by parameter <i>28.79 Ramp output balance enable</i> .	0.0 Hz
	-500.00 ... 500.00 Hz	Frequency ramp balancing reference.	See par. <a href="#">46.02</a>
<b>28.79</b>	<i>Ramp output balance enable</i>	Selects the source for enabling/disabling speed ramp balancing. See parameter <i>28.78 Ramp output balance</i> . 0 = Disabled 1 = Enabled	<i>Off</i>
	Off	0.	
	On	1.	
	DI1	Digital input DI1 ( <i>10.02 DI delayed status</i> , bit 0).	2
	DI2	Digital input DI2 ( <i>10.02 DI delayed status</i> , bit 1).	3
	DI3	Digital input DI3 ( <i>10.02 DI delayed status</i> , bit 2).	4
	DI4	Digital input DI4 ( <i>10.02 DI delayed status</i> , bit 3).	5
	DI5	Digital input DI5 ( <i>10.02 DI delayed status</i> , bit 4).	6
	DI6	Digital input DI6 ( <i>10.02 DI delayed status</i> , bit 5).	7
	DIO1	Digital input/output DIO1 ( <i>11.02 DIO delayed status</i> , bit 0).	10
	DIO2	Digital input/output DIO2 ( <i>11.02 DIO delayed status</i> , bit 1).	11
	<i>Other [bit]</i>	Source selection (see <i>Terms and abbreviations</i> on page 81).	-
<b>28.90</b>	<i>Frequency ref1 act</i>	Displays the value of frequency reference source 1 (selected by parameter <i>28.11 Frequency ref1 selection</i> ). See the control chain diagram on page 358. This parameter is read-only.	-
	-500.00 ... 500.00 Hz	Value of frequency reference source 1.	See par. <a href="#">46.02</a>
<b>28.91</b>	<i>Frequency ref2 act</i>	Displays the value of frequency reference source 2 (selected by parameter <i>28.12 Frequency ref2 selection</i> ). See the control chain diagram on page 358. This parameter is read-only.	-
	-500.00 ... 500.00 Hz	Value of frequency reference source 2.	See par. <a href="#">46.02</a>

No.	Name/Value	Description	Def/FbEq16
28.92	<i>Frequency ref3 act</i>	Displays the frequency reference after the function applied by parameter <a href="#">28.13 Frequency ref1 function</a> (if any), and after selection ( <a href="#">28.14 Frequency ref1/2 selection</a> ). See the control chain diagram on page <a href="#">358</a> . This parameter is read-only.	-
	-500.00 ... 500.00 Hz	Frequency reference after selection.	See par. <a href="#">46.02</a>
28.96	<i>Frequency ref7 act</i>	Displays the frequency reference after application of constant frequencies, control panel reference, etc. See the control chain diagram on page <a href="#">358</a> . This parameter is read-only.	-
	-500.00 ... 500.00 Hz	Frequency reference 7.	See par. <a href="#">46.02</a>
28.97	<i>Frequency ref unlimited</i>	Displays the frequency reference after application of critical frequencies, but before ramping and limiting. See the control chain diagram on page <a href="#">359</a> . This parameter is read-only.	-
	-500.00 ... 500.00 Hz	Frequency reference before ramping and limiting.	See par. <a href="#">46.02</a>

<b>30 Limits</b>		Drive operation limits.																																																					
30.01	<i>Limit word 1</i>	Displays limit word 1. This parameter is read-only.	-																																																				
<table border="1"> <thead> <tr> <th>Bit</th> <th>Name</th> <th>Description</th> <th></th> </tr> </thead> <tbody> <tr> <td>0</td> <td>Torq lim</td> <td>1 = Drive torque is being limited by the motor control (undervoltage control, current control, load angle control or pull-out control), or by the torque limits defined by parameters.</td> <td></td> </tr> <tr> <td>1</td> <td>Spd ctl tlim min</td> <td>1 = Speed controller output is being limited by <a href="#">25.11 Min torque speed control</a></td> <td></td> </tr> <tr> <td>2</td> <td>Spd ctl tlim max</td> <td>1 = Speed controller output is being limited by <a href="#">25.12 Max torque speed control</a></td> <td></td> </tr> <tr> <td>3</td> <td>Torq ref max</td> <td>1 = Torque reference is being limited by <a href="#">26.09 Maximum torque ref</a></td> <td></td> </tr> <tr> <td>4</td> <td>Torq ref min</td> <td>1 = Torque reference is being limited by <a href="#">26.08 Minimum torque ref</a></td> <td></td> </tr> <tr> <td>5</td> <td>Tlim max speed</td> <td>1 = Torque reference is being limited by the rush control because of maximum speed limit (<a href="#">30.12 Maximum speed</a>)</td> <td></td> </tr> <tr> <td>6</td> <td>Tlim min speed</td> <td>1 = Torque reference is being limited by the rush control because of minimum speed limit (<a href="#">30.11 Minimum speed</a>)</td> <td></td> </tr> <tr> <td>7</td> <td>Max speed ref lim</td> <td>1 = Speed reference is being limited by <a href="#">30.12 Maximum speed</a></td> <td></td> </tr> <tr> <td>8</td> <td>Min speed ref lim</td> <td>1 = Speed reference is being limited by <a href="#">30.11 Minimum speed</a></td> <td></td> </tr> <tr> <td>9</td> <td>Max freq ref lim</td> <td>1 = Frequency reference is being limited by <a href="#">30.14 Maximum frequency</a></td> <td></td> </tr> <tr> <td>10</td> <td>Min freq ref lim</td> <td>1 = Frequency reference is being limited by <a href="#">30.13 Minimum frequency</a></td> <td></td> </tr> <tr> <td>11...15</td> <td>Reserved</td> <td></td> <td></td> </tr> </tbody> </table>				Bit	Name	Description		0	Torq lim	1 = Drive torque is being limited by the motor control (undervoltage control, current control, load angle control or pull-out control), or by the torque limits defined by parameters.		1	Spd ctl tlim min	1 = Speed controller output is being limited by <a href="#">25.11 Min torque speed control</a>		2	Spd ctl tlim max	1 = Speed controller output is being limited by <a href="#">25.12 Max torque speed control</a>		3	Torq ref max	1 = Torque reference is being limited by <a href="#">26.09 Maximum torque ref</a>		4	Torq ref min	1 = Torque reference is being limited by <a href="#">26.08 Minimum torque ref</a>		5	Tlim max speed	1 = Torque reference is being limited by the rush control because of maximum speed limit ( <a href="#">30.12 Maximum speed</a> )		6	Tlim min speed	1 = Torque reference is being limited by the rush control because of minimum speed limit ( <a href="#">30.11 Minimum speed</a> )		7	Max speed ref lim	1 = Speed reference is being limited by <a href="#">30.12 Maximum speed</a>		8	Min speed ref lim	1 = Speed reference is being limited by <a href="#">30.11 Minimum speed</a>		9	Max freq ref lim	1 = Frequency reference is being limited by <a href="#">30.14 Maximum frequency</a>		10	Min freq ref lim	1 = Frequency reference is being limited by <a href="#">30.13 Minimum frequency</a>		11...15	Reserved		
Bit	Name	Description																																																					
0	Torq lim	1 = Drive torque is being limited by the motor control (undervoltage control, current control, load angle control or pull-out control), or by the torque limits defined by parameters.																																																					
1	Spd ctl tlim min	1 = Speed controller output is being limited by <a href="#">25.11 Min torque speed control</a>																																																					
2	Spd ctl tlim max	1 = Speed controller output is being limited by <a href="#">25.12 Max torque speed control</a>																																																					
3	Torq ref max	1 = Torque reference is being limited by <a href="#">26.09 Maximum torque ref</a>																																																					
4	Torq ref min	1 = Torque reference is being limited by <a href="#">26.08 Minimum torque ref</a>																																																					
5	Tlim max speed	1 = Torque reference is being limited by the rush control because of maximum speed limit ( <a href="#">30.12 Maximum speed</a> )																																																					
6	Tlim min speed	1 = Torque reference is being limited by the rush control because of minimum speed limit ( <a href="#">30.11 Minimum speed</a> )																																																					
7	Max speed ref lim	1 = Speed reference is being limited by <a href="#">30.12 Maximum speed</a>																																																					
8	Min speed ref lim	1 = Speed reference is being limited by <a href="#">30.11 Minimum speed</a>																																																					
9	Max freq ref lim	1 = Frequency reference is being limited by <a href="#">30.14 Maximum frequency</a>																																																					
10	Min freq ref lim	1 = Frequency reference is being limited by <a href="#">30.13 Minimum frequency</a>																																																					
11...15	Reserved																																																						
0000h...FFFFh		Limit word 1.	1 = 1																																																				

No.	Name/Value	Description	Def/FbEq16																																										
30.02	<i>Torque limit status</i>	Displays the torque controller limitation status word. This parameter is read-only.	-																																										
		<table border="1"> <thead> <tr> <th>Bit</th> <th>Name</th> <th>Description</th> </tr> </thead> <tbody> <tr> <td>0</td> <td>Undervoltage</td> <td>*1 = Intermediate DC circuit undervoltage</td> </tr> <tr> <td>1</td> <td>Overvoltage</td> <td>*1 = Intermediate DC circuit overvoltage</td> </tr> <tr> <td>2</td> <td>Minimum torque</td> <td>*1 = Torque is being limited by <a href="#">30.19 Minimum torque</a></td> </tr> <tr> <td>3</td> <td>Maximum torque</td> <td>*1 = Torque is being limited by <a href="#">30.20 Maximum torque</a></td> </tr> <tr> <td>4</td> <td>Internal current</td> <td>1 = An inverter current limit (identified by bits 8...11) is active</td> </tr> <tr> <td>5</td> <td>Load angle</td> <td>(With permanent magnet motors and reluctance motors only) 1 = Load angle limit is active, ie. the motor cannot produce any more torque</td> </tr> <tr> <td>6</td> <td>Motor pullout</td> <td>(With asynchronous motors only) Motor pull-out limit is active, ie. the motor cannot produce anymore torque</td> </tr> <tr> <td>7</td> <td>Reserved</td> <td></td> </tr> <tr> <td>8</td> <td>Thermal</td> <td>1 = Input current is being limited by the main circuit thermal limit</td> </tr> <tr> <td>9</td> <td>SOA current</td> <td>*1 = Maximum output current (<math>I_{MAX}</math>) is being limited</td> </tr> <tr> <td>10</td> <td>User current</td> <td>*1 = Output current is being limited by <a href="#">30.17 Maximum current</a></td> </tr> <tr> <td>11</td> <td>Thermal IGBT</td> <td>*1 = Output current is being limited by a calculated thermal current value</td> </tr> <tr> <td>12...15</td> <td>Reserved</td> <td></td> </tr> </tbody> </table> <p>*Only one out of bits 0...3, and one out of bits 9...11 can be on simultaneously. The bit typically indicates the limit that is exceeded first.</p>	Bit	Name	Description	0	Undervoltage	*1 = Intermediate DC circuit undervoltage	1	Overvoltage	*1 = Intermediate DC circuit overvoltage	2	Minimum torque	*1 = Torque is being limited by <a href="#">30.19 Minimum torque</a>	3	Maximum torque	*1 = Torque is being limited by <a href="#">30.20 Maximum torque</a>	4	Internal current	1 = An inverter current limit (identified by bits 8...11) is active	5	Load angle	(With permanent magnet motors and reluctance motors only) 1 = Load angle limit is active, ie. the motor cannot produce any more torque	6	Motor pullout	(With asynchronous motors only) Motor pull-out limit is active, ie. the motor cannot produce anymore torque	7	Reserved		8	Thermal	1 = Input current is being limited by the main circuit thermal limit	9	SOA current	*1 = Maximum output current ( $I_{MAX}$ ) is being limited	10	User current	*1 = Output current is being limited by <a href="#">30.17 Maximum current</a>	11	Thermal IGBT	*1 = Output current is being limited by a calculated thermal current value	12...15	Reserved		
Bit	Name	Description																																											
0	Undervoltage	*1 = Intermediate DC circuit undervoltage																																											
1	Overvoltage	*1 = Intermediate DC circuit overvoltage																																											
2	Minimum torque	*1 = Torque is being limited by <a href="#">30.19 Minimum torque</a>																																											
3	Maximum torque	*1 = Torque is being limited by <a href="#">30.20 Maximum torque</a>																																											
4	Internal current	1 = An inverter current limit (identified by bits 8...11) is active																																											
5	Load angle	(With permanent magnet motors and reluctance motors only) 1 = Load angle limit is active, ie. the motor cannot produce any more torque																																											
6	Motor pullout	(With asynchronous motors only) Motor pull-out limit is active, ie. the motor cannot produce anymore torque																																											
7	Reserved																																												
8	Thermal	1 = Input current is being limited by the main circuit thermal limit																																											
9	SOA current	*1 = Maximum output current ( $I_{MAX}$ ) is being limited																																											
10	User current	*1 = Output current is being limited by <a href="#">30.17 Maximum current</a>																																											
11	Thermal IGBT	*1 = Output current is being limited by a calculated thermal current value																																											
12...15	Reserved																																												
	0000h...FFFFh	Torque limitation status word.	1 = 1																																										
30.11	<i>Minimum speed</i>	Defines the minimum allowed speed.  <b>WARNING!</b> This value must not be higher than <a href="#">30.12 Maximum speed</a> .  <b>WARNING!</b> In frequency control mode, this limit is not effective. Make sure the frequency limits ( <a href="#">30.13</a> and <a href="#">30.14</a> ) are set appropriately if frequency control is used.	-1500.00 rpm																																										
	-30000.00 ... 30000.00 rpm	Minimum allowed speed.	See par. <a href="#">46.01</a>																																										
30.12	<i>Maximum speed</i>	Defines the maximum allowed speed.  <b>WARNING!</b> This value must not be lower than <a href="#">30.11 Minimum speed</a> .  <b>WARNING!</b> In frequency control mode, this limit is not effective. Make sure the frequency limits ( <a href="#">30.13</a> and <a href="#">30.14</a> ) are set appropriately if frequency control is used.	1500.00 rpm																																										
	-30000.00 ... 30000.00 rpm	Maximum speed.	See par. <a href="#">46.01</a>																																										
30.13	<i>Minimum frequency</i>	Defines the minimum allowed frequency.  <b>WARNING!</b> This value must not be higher than <a href="#">30.14 Maximum frequency</a> .	-50.00 Hz																																										
	-500.00 ... 500.00 Hz	Minimum frequency.	See par. <a href="#">46.02</a>																																										



No.	Name/Value	Description	Def/FbEq16
30.14	<i>Maximum frequency</i>	Defines the maximum allowed frequency.  <b>WARNING!</b> This value must not be lower than <a href="#">30.13</a> <i>Minimum frequency</i> .	50.00 Hz
	-500.00 ... 500.00 Hz	Maximum frequency.	See par. <a href="#">46.02</a>
30.17	<i>Maximum current</i>	Defines the maximum allowed motor current.	0.00 A
	0.00 ... 30000.00 A	Maximum motor current.	1 = 1 A
30.19	<i>Minimum torque</i>	Defines the minimum torque limit for the drive (in percent of nominal motor torque).	-300.0%
	-1600.0 ... 1600.0%	Minimum torque.	See par. <a href="#">46.03</a>
30.20	<i>Maximum torque</i>	Defines the maximum torque limit for the drive (in percent of nominal motor torque).	300.0%
	-1600.0 ... 1600.0%	Maximum torque.	See par. <a href="#">46.03</a>
30.26	<i>Power motoring limit</i>	Defines the maximum allowed power fed by the inverter to the motor in percent of nominal motor power.	300.00%
	0.00 ... 600.00%	Maximum motoring power.	1 = 1%
30.27	<i>Power generating limit</i>	Defines the maximum allowed power fed by the motor to the inverter in percent of nominal motor power.	-300.00%
	-600.00 ... 0.00%	Maximum generating power.	1 = 1%
30.30	<i>Overvoltage control</i>	Enables the overvoltage control of the intermediate DC link. Fast braking of a high inertia load causes the voltage to rise to the overvoltage control limit. To prevent the DC voltage from exceeding the limit, the overvoltage controller automatically decreases the braking torque. <b>Note:</b> If the drive is equipped with a brake chopper and resistor, or a regenerative supply unit, the controller must be disabled.	<i>Enable</i>
	Disable	Overvoltage control disabled.	0
	Enable	Overvoltage control enabled.	1
30.31	<i>Undervoltage control</i>	Enables the undervoltage control of the intermediate DC link. If the DC voltage drops due to input power cut off, the undervoltage controller will automatically decrease the motor torque in order to keep the voltage above the lower limit. By decreasing the motor torque, the inertia of the load will cause regeneration back to the drive, keeping the DC link charged and preventing an undervoltage trip until the motor coasts to a stop. This will act as a power-loss ride-through functionality in systems with high inertia, such as a centrifuge or a fan.	<i>Enable</i>
	Disable	Undervoltage control disabled.	0
	Enable	Undervoltage control enabled.	1
<b>31 Fault functions</b>		Settings that define the behavior of the drive upon fault situations.	
31.01	<i>External event 1 source</i>	Defines the source of external event 1. See also parameter <a href="#">31.02</a> <i>External event 1 type</i> . 0 = Trigger event 1 = Normal operation	<i>Inactive (true)</i>
	Active (false)	0.	0
	Inactive (true)	1.	1

## 178 Parameters

No.	Name/Value	Description	Def/FbEq16
	DIIL	DIIL input ( <a href="#">10.02 DI delayed status</a> , bit 15).	2
	DI1	Digital input DI1 ( <a href="#">10.02 DI delayed status</a> , bit 0).	3
	DI2	Digital input DI2 ( <a href="#">10.02 DI delayed status</a> , bit 1).	4
	DI3	Digital input DI3 ( <a href="#">10.02 DI delayed status</a> , bit 2).	5
	DI4	Digital input DI4 ( <a href="#">10.02 DI delayed status</a> , bit 3).	6
	DI5	Digital input DI5 ( <a href="#">10.02 DI delayed status</a> , bit 4).	7
	DI6	Digital input DI6 ( <a href="#">10.02 DI delayed status</a> , bit 5).	8
	DIO1	Digital input/output DIO1 ( <a href="#">11.02 DIO delayed status</a> , bit 0).	11
	DIO2	Digital input/output DIO2 ( <a href="#">11.02 DIO delayed status</a> , bit 1).	12
	<i>Other [bit]</i>	Source selection (see <a href="#">Terms and abbreviations</a> on page 81).	-
<a href="#">31.02</a>	<a href="#">External event 1 type</a>	Selects the type of external event 1.	<i>Fault</i>
	Fault	The external event generates a fault.	0
	Warning	The external event generates a warning.	1
<a href="#">31.03</a>	<a href="#">External event 2 source</a>	Defines the source of external event 2. See also parameter <a href="#">31.04 External event 2 type</a> . For the selections, see parameter <a href="#">31.01 External event 1 source</a> .	<i>Inactive (true)</i>
<a href="#">31.04</a>	<a href="#">External event 2 type</a>	Selects the type of external event 2.	
	Fault	The external event generates a fault.	0
	Warning	The external event generates a warning.	1
<a href="#">31.05</a>	<a href="#">External event 3 source</a>	Defines the source of external event 3. See also parameter <a href="#">31.06 External event 3 type</a> . For the selections, see parameter <a href="#">31.01 External event 1 source</a> .	<i>Inactive (true)</i>
<a href="#">31.06</a>	<a href="#">External event 3 type</a>	Selects the type of external event 3.	
	Fault	The external event generates a fault.	0
	Warning	The external event generates a warning.	1
<a href="#">31.07</a>	<a href="#">External event 4 source</a>	Defines the source of external event 4. See also parameter <a href="#">31.08 External event 4 type</a> . For the selections, see parameter <a href="#">31.01 External event 1 source</a> .	<i>Inactive (true)</i>
<a href="#">31.08</a>	<a href="#">External event 4 type</a>	Selects the type of external event 4.	
	Fault	The external event generates a fault.	0
	Warning	The external event generates a warning.	1
<a href="#">31.09</a>	<a href="#">External event 5 source</a>	Defines the source of external event 5. See also parameter <a href="#">31.10 External event 5 type</a> . For the selections, see parameter <a href="#">31.01 External event 1 source</a> .	<i>Inactive (true)</i>
<a href="#">31.10</a>	<a href="#">External event 5 type</a>	Selects the type of external event 5.	
	Fault	The external event generates a fault.	0
	Warning	The external event generates a warning.	1

No.	Name/Value	Description	Def/FbEq16																						
31.11	<i>Fault reset selection</i>	Selects the source of an external fault reset signal. The signal resets the drive after a fault trip if the cause of the fault no longer exists. 0 -> 1 = Reset <b>Note:</b> A fault reset from the fieldbus interface is always observed regardless of this parameter.	<i>DI3</i>																						
	Off	0.	0																						
	On	1.	1																						
	DI1	Digital input DI1 ( <i>10.02 DI delayed status</i> , bit 0).	2																						
	DI2	Digital input DI2 ( <i>10.02 DI delayed status</i> , bit 1).	3																						
	DI3	Digital input DI3 ( <i>10.02 DI delayed status</i> , bit 2).	4																						
	DI4	Digital input DI4 ( <i>10.02 DI delayed status</i> , bit 3).	5																						
	DI5	Digital input DI5 ( <i>10.02 DI delayed status</i> , bit 4).	6																						
	DI6	Digital input DI6 ( <i>10.02 DI delayed status</i> , bit 5).	7																						
	DIO1	Digital input/output DIO1 ( <i>11.02 DIO delayed status</i> , bit 0).	10																						
	DIO2	Digital input/output DIO2 ( <i>11.02 DIO delayed status</i> , bit 1).	11																						
	<i>Other [bit]</i>	Source selection (see <i>Terms and abbreviations</i> on page 81).	-																						
31.12	<i>Autoreset sel</i>	Selects faults that are automatically reset. The parameter is a 16-bit word with each bit corresponding to a fault type. Whenever a bit is set to 1, the corresponding fault is automatically reset. <b>Note:</b> The autoreset function is only available in external control; see section <i>Local control vs. external control</i> (page 18). The bits of the binary number correspond to the following faults:	0000h																						
<table border="1"> <thead> <tr> <th>Bit</th> <th>Fault</th> </tr> </thead> <tbody> <tr> <td>0</td> <td>Overcurrent</td> </tr> <tr> <td>1</td> <td>Overvoltage</td> </tr> <tr> <td>2</td> <td>Undervoltage</td> </tr> <tr> <td>3...9</td> <td>Reserved</td> </tr> <tr> <td>10</td> <td>Selectable fault (see parameter <i>31.13 Selectable fault</i>)</td> </tr> <tr> <td>11</td> <td>External fault 1 (from source selected by parameter <i>31.01 External event 1 source</i>)</td> </tr> <tr> <td>12</td> <td>External fault 2 (from source selected by parameter <i>31.03 External event 2 source</i>)</td> </tr> <tr> <td>13</td> <td>External fault 3 (from source selected by parameter <i>31.05 External event 3 source</i>)</td> </tr> <tr> <td>14</td> <td>External fault 4 (from source selected by parameter <i>31.07 External event 4 source</i>)</td> </tr> <tr> <td>15</td> <td>External fault 5 (from source selected by parameter <i>31.09 External event 5 source</i>)</td> </tr> </tbody> </table>				Bit	Fault	0	Overcurrent	1	Overvoltage	2	Undervoltage	3...9	Reserved	10	Selectable fault (see parameter <i>31.13 Selectable fault</i> )	11	External fault 1 (from source selected by parameter <i>31.01 External event 1 source</i> )	12	External fault 2 (from source selected by parameter <i>31.03 External event 2 source</i> )	13	External fault 3 (from source selected by parameter <i>31.05 External event 3 source</i> )	14	External fault 4 (from source selected by parameter <i>31.07 External event 4 source</i> )	15	External fault 5 (from source selected by parameter <i>31.09 External event 5 source</i> )
Bit	Fault																								
0	Overcurrent																								
1	Overvoltage																								
2	Undervoltage																								
3...9	Reserved																								
10	Selectable fault (see parameter <i>31.13 Selectable fault</i> )																								
11	External fault 1 (from source selected by parameter <i>31.01 External event 1 source</i> )																								
12	External fault 2 (from source selected by parameter <i>31.03 External event 2 source</i> )																								
13	External fault 3 (from source selected by parameter <i>31.05 External event 3 source</i> )																								
14	External fault 4 (from source selected by parameter <i>31.07 External event 4 source</i> )																								
15	External fault 5 (from source selected by parameter <i>31.09 External event 5 source</i> )																								
	0000h...FFFFh	Automatic reset configuration word.	1 = 1																						
31.13	<i>Selectable fault</i>	Defines the fault that can be automatically reset using parameter <i>31.12 Autoreset sel</i> , bit 10. The code is given in decimal. The faults are listed in chapter <i>Fault tracing</i> (page 311).	0																						
	0...65535	Fault code.	10 = 1																						
31.14	<i>Number of trials</i>	Defines the number of automatic fault resets the drive performs within the time defined by parameter <i>31.15 Trial time</i> .	0																						
	0...5	Number of automatic resets.	10 = 1																						

No.	Name/Value	Description	Def/FbEq16																	
31.15	<i>Trial time</i>	Defines the time for the automatic reset function. See parameter <a href="#">31.14 Number of trials</a> .	30.0 s																	
	1.0 ... 600.0 s	Time for automatic resets.	10 = 1 s																	
31.16	<i>Delay time</i>	Defines the time that the drive will wait after a fault before attempting an automatic reset. See parameter <a href="#">31.12 Autoreset sel.</a>	0.0 s																	
	0.0 ... 120.0 s	Autoreset delay.	10 = 1 s																	
31.19	<i>Motor phase loss</i>	Selects how the drive reacts when a motor phase loss is detected.	<i>Fault</i>																	
	No	No action taken.	0																	
	Fault	The drive trips on fault <a href="#">3381 Output phase loss</a> .	1																	
31.20	<i>Earth fault</i>	Selects how the drive reacts when an earth fault or current unbalance is detected in the motor or the motor cable.	<i>Fault</i>																	
	No	No action taken.	0																	
	Warning	The drive generates an <a href="#">A2B3 Earth leakage</a> warning.	1																	
	Fault	The drive trips on fault <a href="#">2330 Earth leakage</a> .	2																	
31.21	<i>Supply phase loss</i>	Selects how the drive reacts when a supply phase loss is detected.	<i>Fault</i>																	
	No	No action taken.	0																	
	Fault	The drive trips on fault <a href="#">3130 Input phase loss</a> .	1																	
31.22	<i>STO indication run/stop</i>	<p>Selects which indications are given when one or both Safe torque off (STO) signals are switched off or lost. The indications also depend on whether the drive is running or stopped when this occurs.</p> <p>The tables at each selection below show the indications generated with that particular setting.</p> <p><b>Notes:</b></p> <ul style="list-style-type: none"> <li>This parameter does not affect the operation of the STO function itself. The STO function will operate regardless of the setting of this parameter: a running drive will stop upon removal of one or both STO signals, and will not start until both STO signals are restored and all faults reset.</li> <li>The loss of only one STO signal always generates a fault as it is interpreted as a malfunction.</li> </ul> <p>For more information on the STO, see the <i>Hardware manual</i> of the drive.</p>	<i>Fault/Fault</i>																	
	Fault/Fault	<table border="1"> <thead> <tr> <th colspan="2">Inputs</th> <th rowspan="2">Indication (running or stopped)</th> </tr> <tr> <th>IN1</th> <th>IN2</th> </tr> </thead> <tbody> <tr> <td>0</td> <td>0</td> <td>Fault <a href="#">5091 Safe torque off</a></td> </tr> <tr> <td>0</td> <td>1</td> <td>Faults <a href="#">5091 Safe torque off</a> and <a href="#">FA81 Safe torque off 1</a></td> </tr> <tr> <td>1</td> <td>0</td> <td>Faults <a href="#">5091 Safe torque off</a> and <a href="#">FA82 Safe torque off 2</a></td> </tr> <tr> <td>1</td> <td>1</td> <td>(Normal operation)</td> </tr> </tbody> </table>	Inputs		Indication (running or stopped)	IN1	IN2	0	0	Fault <a href="#">5091 Safe torque off</a>	0	1	Faults <a href="#">5091 Safe torque off</a> and <a href="#">FA81 Safe torque off 1</a>	1	0	Faults <a href="#">5091 Safe torque off</a> and <a href="#">FA82 Safe torque off 2</a>	1	1	(Normal operation)	0
Inputs		Indication (running or stopped)																		
IN1	IN2																			
0	0	Fault <a href="#">5091 Safe torque off</a>																		
0	1	Faults <a href="#">5091 Safe torque off</a> and <a href="#">FA81 Safe torque off 1</a>																		
1	0	Faults <a href="#">5091 Safe torque off</a> and <a href="#">FA82 Safe torque off 2</a>																		
1	1	(Normal operation)																		

No.	Name/Value	Description	Def/FbEq16																								
	Fault/Warning	<table border="1"> <thead> <tr> <th colspan="2">Inputs</th> <th colspan="2">Indication</th> </tr> <tr> <th>IN1</th> <th>IN2</th> <th>Running</th> <th>Stopped</th> </tr> </thead> <tbody> <tr> <td>0</td> <td>0</td> <td>Fault <i>5091 Safe torque off</i></td> <td>Warning <i>A5A0 Safe torque off</i></td> </tr> <tr> <td>0</td> <td>1</td> <td>Faults <i>5091 Safe torque off</i> and <i>FA81 Safe torque off 1</i></td> <td>Warning <i>A5A0 Safe torque off</i> and fault <i>FA81 Safe torque off 1</i></td> </tr> <tr> <td>1</td> <td>0</td> <td>Faults <i>5091 Safe torque off</i> and <i>FA82 Safe torque off 2</i></td> <td>Warning <i>A5A0 Safe torque off</i> and fault <i>FA82 Safe torque off 2</i></td> </tr> <tr> <td>1</td> <td>1</td> <td colspan="2">(Normal operation)</td> </tr> </tbody> </table>	Inputs		Indication		IN1	IN2	Running	Stopped	0	0	Fault <i>5091 Safe torque off</i>	Warning <i>A5A0 Safe torque off</i>	0	1	Faults <i>5091 Safe torque off</i> and <i>FA81 Safe torque off 1</i>	Warning <i>A5A0 Safe torque off</i> and fault <i>FA81 Safe torque off 1</i>	1	0	Faults <i>5091 Safe torque off</i> and <i>FA82 Safe torque off 2</i>	Warning <i>A5A0 Safe torque off</i> and fault <i>FA82 Safe torque off 2</i>	1	1	(Normal operation)		1
Inputs		Indication																									
IN1	IN2	Running	Stopped																								
0	0	Fault <i>5091 Safe torque off</i>	Warning <i>A5A0 Safe torque off</i>																								
0	1	Faults <i>5091 Safe torque off</i> and <i>FA81 Safe torque off 1</i>	Warning <i>A5A0 Safe torque off</i> and fault <i>FA81 Safe torque off 1</i>																								
1	0	Faults <i>5091 Safe torque off</i> and <i>FA82 Safe torque off 2</i>	Warning <i>A5A0 Safe torque off</i> and fault <i>FA82 Safe torque off 2</i>																								
1	1	(Normal operation)																									
	Fault/Event	<table border="1"> <thead> <tr> <th colspan="2">Inputs</th> <th colspan="2">Indication</th> </tr> <tr> <th>IN1</th> <th>IN2</th> <th>Running</th> <th>Stopped</th> </tr> </thead> <tbody> <tr> <td>0</td> <td>0</td> <td>Fault <i>5091 Safe torque off</i></td> <td>Event <i>B5A0 Safe torque off</i></td> </tr> <tr> <td>0</td> <td>1</td> <td>Faults <i>5091 Safe torque off</i> and <i>FA81 Safe torque off 1</i></td> <td>Event <i>B5A0 Safe torque off</i> and fault <i>FA81 Safe torque off 1</i></td> </tr> <tr> <td>1</td> <td>0</td> <td>Faults <i>5091 Safe torque off</i> and <i>FA82 Safe torque off 2</i></td> <td>Event <i>B5A0 Safe torque off</i> and fault <i>FA82 Safe torque off 2</i></td> </tr> <tr> <td>1</td> <td>1</td> <td colspan="2">(Normal operation)</td> </tr> </tbody> </table>	Inputs		Indication		IN1	IN2	Running	Stopped	0	0	Fault <i>5091 Safe torque off</i>	Event <i>B5A0 Safe torque off</i>	0	1	Faults <i>5091 Safe torque off</i> and <i>FA81 Safe torque off 1</i>	Event <i>B5A0 Safe torque off</i> and fault <i>FA81 Safe torque off 1</i>	1	0	Faults <i>5091 Safe torque off</i> and <i>FA82 Safe torque off 2</i>	Event <i>B5A0 Safe torque off</i> and fault <i>FA82 Safe torque off 2</i>	1	1	(Normal operation)		2
Inputs		Indication																									
IN1	IN2	Running	Stopped																								
0	0	Fault <i>5091 Safe torque off</i>	Event <i>B5A0 Safe torque off</i>																								
0	1	Faults <i>5091 Safe torque off</i> and <i>FA81 Safe torque off 1</i>	Event <i>B5A0 Safe torque off</i> and fault <i>FA81 Safe torque off 1</i>																								
1	0	Faults <i>5091 Safe torque off</i> and <i>FA82 Safe torque off 2</i>	Event <i>B5A0 Safe torque off</i> and fault <i>FA82 Safe torque off 2</i>																								
1	1	(Normal operation)																									
	Warning/Warning	<table border="1"> <thead> <tr> <th colspan="2">Inputs</th> <th rowspan="2">Indication (running or stopped)</th> </tr> <tr> <th>IN1</th> <th>IN2</th> </tr> </thead> <tbody> <tr> <td>0</td> <td>0</td> <td>Warning <i>A5A0 Safe torque off</i></td> </tr> <tr> <td>0</td> <td>1</td> <td>Warning <i>A5A0 Safe torque off</i> and fault <i>FA81 Safe torque off 1</i></td> </tr> <tr> <td>1</td> <td>0</td> <td>Warning <i>A5A0 Safe torque off</i> and fault <i>FA82 Safe torque off 2</i></td> </tr> <tr> <td>1</td> <td>1</td> <td>(Normal operation)</td> </tr> </tbody> </table>	Inputs		Indication (running or stopped)	IN1	IN2	0	0	Warning <i>A5A0 Safe torque off</i>	0	1	Warning <i>A5A0 Safe torque off</i> and fault <i>FA81 Safe torque off 1</i>	1	0	Warning <i>A5A0 Safe torque off</i> and fault <i>FA82 Safe torque off 2</i>	1	1	(Normal operation)	3							
Inputs		Indication (running or stopped)																									
IN1	IN2																										
0	0	Warning <i>A5A0 Safe torque off</i>																									
0	1	Warning <i>A5A0 Safe torque off</i> and fault <i>FA81 Safe torque off 1</i>																									
1	0	Warning <i>A5A0 Safe torque off</i> and fault <i>FA82 Safe torque off 2</i>																									
1	1	(Normal operation)																									
	Event/Event	<table border="1"> <thead> <tr> <th colspan="2">Inputs</th> <th rowspan="2">Indication (running or stopped)</th> </tr> <tr> <th>IN1</th> <th>IN2</th> </tr> </thead> <tbody> <tr> <td>0</td> <td>0</td> <td>Event <i>B5A0 Safe torque off</i></td> </tr> <tr> <td>0</td> <td>1</td> <td>Event <i>B5A0 Safe torque off</i> and fault <i>FA81 Safe torque off 1</i></td> </tr> <tr> <td>1</td> <td>0</td> <td>Event <i>B5A0 Safe torque off</i> and fault <i>FA82 Safe torque off 2</i></td> </tr> <tr> <td>1</td> <td>1</td> <td>(Normal operation)</td> </tr> </tbody> </table>	Inputs		Indication (running or stopped)	IN1	IN2	0	0	Event <i>B5A0 Safe torque off</i>	0	1	Event <i>B5A0 Safe torque off</i> and fault <i>FA81 Safe torque off 1</i>	1	0	Event <i>B5A0 Safe torque off</i> and fault <i>FA82 Safe torque off 2</i>	1	1	(Normal operation)	4							
Inputs		Indication (running or stopped)																									
IN1	IN2																										
0	0	Event <i>B5A0 Safe torque off</i>																									
0	1	Event <i>B5A0 Safe torque off</i> and fault <i>FA81 Safe torque off 1</i>																									
1	0	Event <i>B5A0 Safe torque off</i> and fault <i>FA82 Safe torque off 2</i>																									
1	1	(Normal operation)																									

## 182 Parameters

No.	Name/Value	Description	Def/FbEq16																	
	No indication/No indication	<table border="1"> <thead> <tr> <th colspan="2">Inputs</th> <th rowspan="2">Indication (running or stopped)</th> </tr> <tr> <th>IN1</th> <th>IN2</th> </tr> </thead> <tbody> <tr> <td>0</td> <td>0</td> <td>None</td> </tr> <tr> <td>0</td> <td>1</td> <td>Fault <i>FA81 Safe torque off 1</i></td> </tr> <tr> <td>1</td> <td>0</td> <td>Fault <i>FA82 Safe torque off 2</i></td> </tr> <tr> <td>1</td> <td>1</td> <td>(Normal operation)</td> </tr> </tbody> </table>	Inputs		Indication (running or stopped)	IN1	IN2	0	0	None	0	1	Fault <i>FA81 Safe torque off 1</i>	1	0	Fault <i>FA82 Safe torque off 2</i>	1	1	(Normal operation)	5
Inputs		Indication (running or stopped)																		
IN1	IN2																			
0	0	None																		
0	1	Fault <i>FA81 Safe torque off 1</i>																		
1	0	Fault <i>FA82 Safe torque off 2</i>																		
1	1	(Normal operation)																		
<b>31.23</b>	<i>Cross connection</i>	Selects how the drive reacts to incorrect input power and motor cable connection (i.e. input power cable is connected to drive motor connection).	<i>Fault</i>																	
	No	No action taken.	0																	
	Fault	The drive trips on fault <i>3181 Cross connection</i> .	1																	
<b>31.24</b>	<i>Stall function</i>	Selects how the drive reacts to a motor stall condition. A stall condition is defined as follows: <ul style="list-style-type: none"> <li>• The drive is at stall current limit (<i>31.25 Stall current limit</i>), and</li> <li>• the output frequency is below the level set by parameter <i>31.27 Stall frequency high</i> or the motor speed is below the level set by parameter <i>31.26 Stall speed high</i>, and</li> <li>• the conditions above have been valid longer than the time set by parameter <i>31.28 Stall time</i>.</li> </ul>	<i>Fault</i>																	
	No	None (stall supervision disabled).	0																	
	Warning	The drive generates an <i>A780 Motor stall</i> warning.	1																	
	Fault	The drive trips on fault <i>7121 Motor stall</i> .	2																	
<b>31.25</b>	<i>Stall current limit</i>	Stall current limit in percent of the nominal current of the motor. See parameter <i>31.24 Stall function</i> .	200.0%																	
	0.0 ... 1600.0%	Stall current limit.	-																	
<b>31.26</b>	<i>Stall speed high</i>	Stall speed limit in rpm. See parameter <i>31.24 Stall function</i> .	150.0 rpm																	
	0.0 ... 10000.0 rpm	Stall speed limit.	See par. <i>46.01</i>																	
<b>31.27</b>	<i>Stall frequency high</i>	Stall frequency limit. See parameter <i>31.24 Stall function</i> . <b>Note:</b> Setting the limit below 10 Hz is not recommended.	15.00 Hz																	
	0.00 ... 500.00 Hz	Stall frequency limit.	See par. <i>46.02</i>																	
<b>31.28</b>	<i>Stall time</i>	Stall time. See parameter <i>31.24 Stall function</i> .	20 s																	
	0 ... 3600 s	Stall time.	-																	

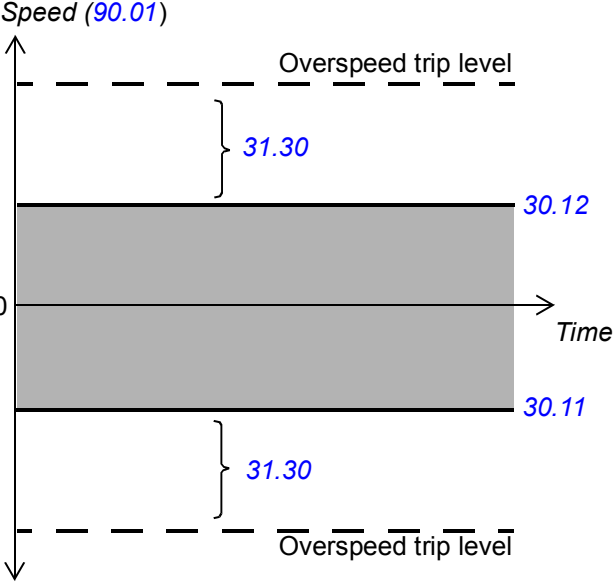
No.	Name/Value	Description	Def/FbEq16															
31.30	<i>Speed trip margin</i>	<p>Defines, together with <a href="#">30.11 Minimum speed</a> and <a href="#">30.12 Maximum speed</a>, the maximum allowed speed of the motor (overspeed protection). If actual speed (<a href="#">90.01 Motor speed for control</a>) exceeds the speed limit defined by parameter <a href="#">30.11</a> or <a href="#">30.12</a> by more than the value of this parameter, the drive trips on the <a href="#">7310 Overspeed</a> fault.</p> <p> <b>WARNING!</b> This function only supervises the speed in DTC motor control mode. The function is not effective in scalar motor control mode.</p> <p><b>Example:</b> If the maximum speed is 1420 rpm and speed trip margin is 300 rpm, the drive trips at 1720 rpm.</p> 	500 rpm															
	0...10000 rpm	Overspeed trip margin.	See par. <a href="#">46.01</a>															
<b>32 Supervision</b>		Configuration of signal supervision functions 1...3. Three values can be chosen to be monitored; a warning or fault is generated whenever predefined limits are exceeded. See also section <a href="#">Signal supervision</a> (page 61).																
32.01	<i>Supervision status</i>	<p>Signal supervision status word. Indicates whether the values monitored by the signal supervision functions are within or outside their respective limits.</p> <p><b>Note:</b> This word is independent of the drive actions defined by parameters <a href="#">32.06</a>, <a href="#">32.16</a> and <a href="#">32.26</a>.</p> <table border="1" data-bbox="302 1697 1439 1888"> <thead> <tr> <th>Bit</th> <th>Name</th> <th>Description</th> </tr> </thead> <tbody> <tr> <td>0</td> <td>Supervision 1 active</td> <td>1 = Signal selected by <a href="#">32.07</a> is outside its limits.</td> </tr> <tr> <td>1</td> <td>Supervision 2 active</td> <td>1 = Signal selected by <a href="#">32.17</a> is outside its limits.</td> </tr> <tr> <td>2</td> <td>Supervision 3 active</td> <td>1 = Signal selected by <a href="#">32.27</a> is outside its limits.</td> </tr> <tr> <td>3...15</td> <td>Reserved</td> <td></td> </tr> </tbody> </table>	Bit	Name	Description	0	Supervision 1 active	1 = Signal selected by <a href="#">32.07</a> is outside its limits.	1	Supervision 2 active	1 = Signal selected by <a href="#">32.17</a> is outside its limits.	2	Supervision 3 active	1 = Signal selected by <a href="#">32.27</a> is outside its limits.	3...15	Reserved		000b
Bit	Name	Description																
0	Supervision 1 active	1 = Signal selected by <a href="#">32.07</a> is outside its limits.																
1	Supervision 2 active	1 = Signal selected by <a href="#">32.17</a> is outside its limits.																
2	Supervision 3 active	1 = Signal selected by <a href="#">32.27</a> is outside its limits.																
3...15	Reserved																	
	000...111b	Signal supervision status word.	1 = 1															

No.	Name/Value	Description	Def/FbEq16
<a href="#">32.05</a>	<a href="#">Supervision 1 function</a>	Selects the mode of signal supervision function 1. Determines how the monitored signal (see parameter <a href="#">32.07</a> ) is compared to its lower and upper limits ( <a href="#">32.09</a> and <a href="#">32.10</a> respectively). The action to be taken when the condition is fulfilled is selected by <a href="#">32.06</a> .	<i>Disabled</i>
	Disabled	Signal supervision 1 not in use.	0
	Low	Action is taken whenever the signal falls below its lower limit.	1
	High	Action is taken whenever the signal rises above its upper limit.	2
	Abs Low	Action is taken whenever the absolute value of the signal falls below its (absolute) lower limit.	3
	Abs High	Action is taken whenever the absolute value of the signal rises above its (absolute) upper limit.	4
	Both	Action is taken whenever the signal falls below its low limit or rises above its high limit.	5
	Abs Both	Action is taken whenever the absolute value of the signal falls below its (absolute) low limit or rises above its (absolute) high limit.	6
<a href="#">32.06</a>	<a href="#">Supervision 1 action</a>	Selects the action the drive takes when the value monitored by signal supervision 1 exceeds its limits. <b>Note:</b> This parameter does not affect the status indicated by <a href="#">32.01 Supervision status</a> .	<i>No</i>
	No	No action taken.	0
	Warning	A warning ( <a href="#">A8B0 Signal supervision</a> ) is generated.	1
	Fault	The drive trips on <a href="#">80B0 Signal supervision</a> .	2
<a href="#">32.07</a>	<a href="#">Supervision 1 signal</a>	Selects the signal to be monitored by signal supervision function 1.	<i>Zero</i>
	Zero	None.	0
	Speed	<a href="#">01.01 Motor speed used</a> (page 84).	1
	Frequency	<a href="#">01.06 Output frequency</a> (page 84).	2
	Current	<a href="#">01.07 Motor current</a> (page 84).	3
	Torque	<a href="#">01.10 Motor torque %</a> (page 84).	4
	DC voltage	<a href="#">01.11 DC voltage</a> (page 84).	5
	Output power	<a href="#">01.14 Output power</a> (page 84).	6
	AI1	<a href="#">12.11 AI1 actual value</a> (page 102).	7
	AI2	<a href="#">12.21 AI2 actual value</a> (page 103).	8
	Speed ref ramp in	<a href="#">23.01 Speed ref ramp in</a> (page 151).	15
	Speed ref ramp out	<a href="#">23.02 Speed ref ramp out</a> (page 151).	16
	Speed ref used	<a href="#">24.01 Used speed reference</a> (page 155).	17
	Torque ref used	<a href="#">26.02 Torque ref used</a> (page 164).	18
	Freq ref used	<a href="#">28.02 Frequency ref ramp out</a> (page 168).	19
	Process PID output	<a href="#">40.01 Process PID actual value</a> (page 203).	20
	Feedback act value	<a href="#">40.02 Feedback actual value</a> (page 203).	21
	Other	The value is taken from another parameter.	-



No.	Name/Value	Description	Def/FbEq16
32.08	<i>Supervision 1 filter time</i>	Defines the filter time constant for signal supervision 1.	0.000 s
	0.000 ... 30.000 s	Signal filter time.	1000 = 1 s
32.09	<i>Supervision 1 low</i>	Defines the lower limit for signal supervision 1.	0.00
	-21474836.48 ... 21474836.47	Low limit.	-
32.10	<i>Supervision 1 high</i>	Defines the upper limit for signal supervision 1.	0.00
	-21474836.48 ... 21474836.47	Upper limit.	-
32.15	<i>Supervision 2 function</i>	Selects the mode of signal supervision function 2. Determines how the monitored signal (see parameter 32.17) is compared to its lower and upper limits (32.19 and 32.20 respectively). The action to be taken when the condition is fulfilled is selected by 32.16.	<i>Disabled</i>
	Disabled	Signal supervision 2 not in use.	0
	Low	Action is taken whenever the signal falls below its lower limit.	1
	High	Action is taken whenever the signal rises above its upper limit.	2
	Abs Low	Action is taken whenever the absolute value of the signal falls below its (absolute) lower limit.	3
	Abs High	Action is taken whenever the absolute value of the signal rises above its (absolute) upper limit.	4
	Both	Action is taken whenever the signal falls below its low limit or rises above its high limit.	5
	Abs Both	Action is taken whenever the absolute value of the signal falls below its (absolute) low limit or rises above its (absolute) high limit.	6
32.16	<i>Supervision 2 action</i>	Selects the action the drive takes when the value monitored by signal supervision 2 exceeds its limits. <b>Note:</b> This parameter does not affect the status indicated by 32.01 <i>Supervision status</i> .	<i>No</i>
	No	No action taken.	0
	Warning	A warning ( <i>A8B0 Signal supervision</i> ) is generated.	1
	Fault	The drive trips on <i>80B0 Signal supervision</i> .	2
32.17	<i>Supervision 2 signal</i>	Selects the signal to be monitored by signal supervision function 2. For the available selections, see parameter 32.07 <i>Supervision 1 signal</i> .	<i>Zero</i>
32.18	<i>Supervision 2 filter time</i>	Defines the filter time constant for signal supervision 2.	0.000 s
	0.000 ... 30.000 s	Signal filter time.	1000 = 1 s
32.19	<i>Supervision 2 low</i>	Defines the lower limit for signal supervision 2.	0.00
	-21474836.48 ... 21474836.47	Low limit.	-
32.20	<i>Supervision 2 high</i>	Defines the upper limit for signal supervision 2.	0.00
	-21474836.48 ... 21474836.47	Upper limit.	-

No.	Name/Value	Description	Def/FbEq16
<a href="#">32.25</a>	<a href="#">Supervision 3 function</a>	Selects the mode of signal supervision function 3. Determines how the monitored signal (see parameter <a href="#">32.27</a> ) is compared to its lower and upper limits ( <a href="#">32.29</a> and <a href="#">32.30</a> respectively). The action to be taken when the condition is fulfilled is selected by <a href="#">32.26</a> .	<i>Disabled</i>
	Disabled	Signal supervision 3 not in use.	0
	Low	Action is taken whenever the signal falls below its lower limit.	1
	High	Action is taken whenever the signal rises above its upper limit.	2
	Abs Low	Action is taken whenever the absolute value of the signal falls below its (absolute) lower limit.	3
	Abs High	Action is taken whenever the absolute value of the signal rises above its (absolute) upper limit.	4
	Both	Action is taken whenever the signal falls below its low limit or rises above its high limit.	5
	Abs Both	Action is taken whenever the absolute value of the signal falls below its (absolute) low limit or rises above its (absolute) high limit.	6
<a href="#">32.26</a>	<a href="#">Supervision 3 action</a>	Selects the action the drive takes when the value monitored by signal supervision 3 exceeds its limits. <b>Note:</b> This parameter does not affect the status indicated by <a href="#">32.01 Supervision status</a> .	<i>No</i>
	No	No action taken.	0
	Warning	A warning ( <a href="#">A8B0 Signal supervision</a> ) is generated.	1
	Fault	The drive trips on <a href="#">80B0 Signal supervision</a> .	2
<a href="#">32.27</a>	<a href="#">Supervision 3 signal</a>	Selects the signal to be monitored by signal supervision function 3. For the available selections, see parameter <a href="#">32.07 Supervision 1 signal</a> .	<i>Zero</i>
<a href="#">32.28</a>	<a href="#">Supervision 3 filter time</a>	Defines the filter time constant for signal supervision 3.	0.000 s
	0.000 ... 30.000 s	Signal filter time.	1000 = 1 s
<a href="#">32.29</a>	<a href="#">Supervision 3 low</a>	Defines the lower limit for signal supervision 3.	0.00
	-21474836.48 ... 21474836.47	Low limit.	-
<a href="#">32.30</a>	<a href="#">Supervision 3 high</a>	Defines the upper limit for signal supervision 3.	0.00
	-21474836.48 ... 21474836.47	Upper limit.	-

No.	Name/Value	Description	Def/FbEq16																								
<b>33 Maintenance timer &amp; counter</b>		Configuration of maintenance timers/counters. See also section <a href="#">Maintenance timers and counters</a> (page 61).																									
<b>33.01</b>	<b>Counter status</b>	Displays the maintenance timer/counter status word, indicating which maintenance timers/counters have exceeded their limits. This parameter is read-only.	-																								
<table border="1"> <thead> <tr> <th>Bit</th> <th>Name</th> <th>Description</th> </tr> </thead> <tbody> <tr> <td>0</td> <td>On-time1</td> <td>1 = On-time timer 1 has reached its preset limit.</td> </tr> <tr> <td>1</td> <td>On-time2</td> <td>1 = On-time timer 2 has reached its preset limit.</td> </tr> <tr> <td>2</td> <td>Edge 1</td> <td>1 = Signal edge counter 1 has reached its preset limit.</td> </tr> <tr> <td>3</td> <td>Edge 2</td> <td>1 = Signal edge counter 2 has reached its preset limit.</td> </tr> <tr> <td>4</td> <td>Value 1</td> <td>1 = Value counter 1 has reached its preset limit.</td> </tr> <tr> <td>5</td> <td>Value 2</td> <td>1 = Value counter 2 has reached its preset limit.</td> </tr> <tr> <td>6...15</td> <td>Reserved</td> <td></td> </tr> </tbody> </table>				Bit	Name	Description	0	On-time1	1 = On-time timer 1 has reached its preset limit.	1	On-time2	1 = On-time timer 2 has reached its preset limit.	2	Edge 1	1 = Signal edge counter 1 has reached its preset limit.	3	Edge 2	1 = Signal edge counter 2 has reached its preset limit.	4	Value 1	1 = Value counter 1 has reached its preset limit.	5	Value 2	1 = Value counter 2 has reached its preset limit.	6...15	Reserved	
Bit	Name	Description																									
0	On-time1	1 = On-time timer 1 has reached its preset limit.																									
1	On-time2	1 = On-time timer 2 has reached its preset limit.																									
2	Edge 1	1 = Signal edge counter 1 has reached its preset limit.																									
3	Edge 2	1 = Signal edge counter 2 has reached its preset limit.																									
4	Value 1	1 = Value counter 1 has reached its preset limit.																									
5	Value 2	1 = Value counter 2 has reached its preset limit.																									
6...15	Reserved																										
	0000h...FFFFh	Maintenance time/counter status word.	1 = 1																								
<b>33.10</b>	<b>On-time 1 actual</b>	Reading of on-time timer 1. Can be reset from the Drive composer PC tool, or from the control panel by keeping Reset depressed for over 3 seconds.	-																								
	0...4294967295 s	Reading of on-time timer 1.	-																								
<b>33.11</b>	<b>On-time 1 limit</b>	Sets the warning limit for on-time timer 1.	0 s																								
	0...4294967295 s	Warning limit for on-time counter 1.	-																								
<b>33.12</b>	<b>On-time 1 function</b>	Configures on-time timer 1. This timer runs whenever the signal selected by parameter <b>33.13 On-time 1 source</b> is on. After the limit set by <b>33.11 On-time 1 limit</b> is reached, the warning specified by <b>33.14 On-time 1 warning select</b> is given (if enabled by this parameter), and the timer reset. The current value of the timer is readable from parameter <b>33.10 On-time 1 actual</b> . Bit 0 of <b>33.01 Counter status</b> indicates that the time has exceeded the limit.	00b																								
<table border="1"> <thead> <tr> <th>Bit</th> <th>Function</th> </tr> </thead> <tbody> <tr> <td>0</td> <td>Counter mode 0 = Loop: If warning is enabled by bit 1, it stays active only for 10 seconds 1 = Saturate: If warning is enabled by bit 1, it stays active until reset</td> </tr> <tr> <td>1</td> <td>Warning enable 0 = Disable: No warning is given when the limit is reached 1 = Enable: A warning is given when the limit is reached</td> </tr> <tr> <td>2...15</td> <td>Reserved</td> </tr> </tbody> </table>				Bit	Function	0	Counter mode 0 = Loop: If warning is enabled by bit 1, it stays active only for 10 seconds 1 = Saturate: If warning is enabled by bit 1, it stays active until reset	1	Warning enable 0 = Disable: No warning is given when the limit is reached 1 = Enable: A warning is given when the limit is reached	2...15	Reserved																
Bit	Function																										
0	Counter mode 0 = Loop: If warning is enabled by bit 1, it stays active only for 10 seconds 1 = Saturate: If warning is enabled by bit 1, it stays active until reset																										
1	Warning enable 0 = Disable: No warning is given when the limit is reached 1 = Enable: A warning is given when the limit is reached																										
2...15	Reserved																										
	0000h...FFFFh	On-time timer 1 configuration word.	1 = 1																								
<b>33.13</b>	<b>On-time 1 source</b>	Selects the signal to be monitored by on-time timer 1.	<i>False</i>																								
	False	Constant 0.	0																								
	True	Constant 1.	1																								
	RO1	Bit 0 of <a href="#">10.21 RO status</a> (page 94).	2																								
	<i>Other [bit]</i>	Source selection (see <a href="#">Terms and abbreviations</a> on page 81).	-																								

No.	Name/Value	Description	Def/FbEq16								
33.14	<a href="#">On-time 1 warning select</a>	Selects the warning message for on-time timer 1.	<a href="#">On-time 1</a>								
	On-time 1	Pre-selectable warning message for on-time timer 1.	0								
	Device clean	Pre-selectable warning message for on-time timer 1.	6								
	Additional cooling fan	Pre-selectable warning message for on-time timer 1.	7								
	Cabinet fan	Pre-selectable warning message for on-time timer 1.	8								
	DC-capacitor	Pre-selectable warning message for on-time timer 1.	9								
	Motor bearing	Pre-selectable warning message for on-time timer 1.	10								
33.20	<a href="#">On-time 2 actual</a>	Reading of on-time timer 2. Can be reset from the Drive composer PC tool, or from the control panel by keeping Reset depressed for over 3 seconds.	-								
	0...4294967295 s	Reading of on-time timer 2.	-								
33.21	<a href="#">On-time 2 limit</a>	Sets the warning limit for on-time timer 2.	0 s								
	0...4294967295 s	Warning limit for on-time counter 2.	-								
33.22	<a href="#">On-time 2 function</a>	Configures on-time timer 2. This timer runs whenever the signal selected by parameter <a href="#">33.23 On-time 2 source</a> is on. After the limit set by <a href="#">33.21 On-time 2 limit</a> is reached, the warning specified by <a href="#">33.24 On-time 2 warning select</a> is given (if enabled by this parameter), and the timer reset. The current value of the timer is readable from parameter <a href="#">33.20 On-time 2 actual</a> . Bit 1 of <a href="#">33.01 Counter status</a> indicates that the time has exceeded the limit.	00b								
<table border="1"> <thead> <tr> <th>Bit</th> <th>Function</th> </tr> </thead> <tbody> <tr> <td>0</td> <td>Counter mode 0 = Loop: If warning is enabled by bit 1, it stays active only for 10 seconds 1 = Saturate: If warning is enabled by bit 1, it stays active until reset</td> </tr> <tr> <td>1</td> <td>Warning enable 0 = Disable: No warning is given when the limit is reached 1 = Enable: A warning is given when the limit is reached</td> </tr> <tr> <td>2...15</td> <td>Reserved</td> </tr> </tbody> </table>				Bit	Function	0	Counter mode 0 = Loop: If warning is enabled by bit 1, it stays active only for 10 seconds 1 = Saturate: If warning is enabled by bit 1, it stays active until reset	1	Warning enable 0 = Disable: No warning is given when the limit is reached 1 = Enable: A warning is given when the limit is reached	2...15	Reserved
Bit	Function										
0	Counter mode 0 = Loop: If warning is enabled by bit 1, it stays active only for 10 seconds 1 = Saturate: If warning is enabled by bit 1, it stays active until reset										
1	Warning enable 0 = Disable: No warning is given when the limit is reached 1 = Enable: A warning is given when the limit is reached										
2...15	Reserved										
	0000h...FFFFh	On-time timer 2 configuration word.	1 = 1								
33.23	<a href="#">On-time 2 source</a>	Selects the signal to be monitored by on-time timer 2.	<a href="#">False</a>								
	False	Constant 0.	0								
	True	Constant 1.	1								
	RO1	Bit 0 of <a href="#">10.21 RO status</a> (page 94).	2								
	<a href="#">Other [bit]</a>	Source selection (see <a href="#">Terms and abbreviations</a> on page 81).	-								
33.24	<a href="#">On-time 2 warning select</a>	Selects the warning message for on-time timer 2.	<a href="#">On-time 2</a>								
	On-time 2	Pre-selectable warning message for on-time timer 2.	1								
	Device clean	Pre-selectable warning message for on-time timer 2.	6								
	Additional cool fan	Pre-selectable warning message for on-time timer 2.	7								
	Cabinet fan	Pre-selectable warning message for on-time timer 2.	8								
	DC-capacitor	Pre-selectable warning message for on-time timer 2.	9								
	Motor bearing	Pre-selectable warning message for on-time timer 2.	10								

No.	Name/Value	Description	Def/FbEq16												
33.30	<a href="#">Edge counter 1 actual</a>	Reading of signal edge counter 1. Can be reset from the Drive composer PC tool, or from the control panel by keeping Reset depressed for over 3 seconds.	-												
	0...4294967295	Reading of signal edge counter 1.	-												
33.31	<a href="#">Edge counter 1 limit</a>	Sets the warning limit for signal edge counter 1.	0												
	0...4294967295	Warning limit for signal edge counter 1.	-												
33.32	<a href="#">Edge counter 1 func</a>	Configures signal edge counter 1. This counter is incremented every time the signal selected by parameter <a href="#">33.33 Edge counter 1 source</a> switches on or off (or either, depending on the setting of this parameter). A divisor may be applied to the count (see <a href="#">33.34 Edge counter 1 divider</a> ). After the limit set by <a href="#">33.31 Edge counter 1 limit</a> is reached, the warning specified by <a href="#">33.35 Edge counter 1 warning selection</a> is given (if enabled by this parameter), and the counter reset. The current value of the counter is readable from parameter <a href="#">33.30 Edge counter 1 actual</a> . Bit 2 of <a href="#">33.01 Counter status</a> indicates that the count has exceeded the limit.	0000b												
<table border="1"> <thead> <tr> <th>Bit</th> <th>Function</th> </tr> </thead> <tbody> <tr> <td>0</td> <td>Counter mode 0 = Loop: If warning is enabled by bit 1, it stays active only for 10 seconds 1 = Saturate: If warning is enabled by bit 1, it stays active until reset</td> </tr> <tr> <td>1</td> <td>Warning enable 0 = Disable: No warning is given when the limit is reached 1 = Enable: A warning is given when the limit is reached</td> </tr> <tr> <td>2</td> <td>Count rising edges 0 = Disable: Rising edges are not counted 1 = Enable: Rising edges are counted</td> </tr> <tr> <td>3</td> <td>Count falling edges 0 = Disable: Falling edges are not counted 1 = Enable: Falling edges are counted</td> </tr> <tr> <td>4...15</td> <td>Reserved</td> </tr> </tbody> </table>				Bit	Function	0	Counter mode 0 = Loop: If warning is enabled by bit 1, it stays active only for 10 seconds 1 = Saturate: If warning is enabled by bit 1, it stays active until reset	1	Warning enable 0 = Disable: No warning is given when the limit is reached 1 = Enable: A warning is given when the limit is reached	2	Count rising edges 0 = Disable: Rising edges are not counted 1 = Enable: Rising edges are counted	3	Count falling edges 0 = Disable: Falling edges are not counted 1 = Enable: Falling edges are counted	4...15	Reserved
Bit	Function														
0	Counter mode 0 = Loop: If warning is enabled by bit 1, it stays active only for 10 seconds 1 = Saturate: If warning is enabled by bit 1, it stays active until reset														
1	Warning enable 0 = Disable: No warning is given when the limit is reached 1 = Enable: A warning is given when the limit is reached														
2	Count rising edges 0 = Disable: Rising edges are not counted 1 = Enable: Rising edges are counted														
3	Count falling edges 0 = Disable: Falling edges are not counted 1 = Enable: Falling edges are counted														
4...15	Reserved														
	0000h...FFFFh	Edge counter 1 configuration word.	1 = 1												
33.33	<a href="#">Edge counter 1 source</a>	Selects the signal to be monitored by signal edge counter 1.	<i>False</i>												
	False	Constant 0.	0												
	True	Constant 1.	1												
	RO1	Bit 0 of <a href="#">10.21 RO status</a> (page 94).	2												
	<i>Other [bit]</i>	Source selection (see <a href="#">Terms and abbreviations</a> on page 81).	-												
33.34	<a href="#">Edge counter 1 divider</a>	Divisor for signal edge counter 1. Determines how many signal edges increment the counter by 1.	1												
	1...4294967295	Divisor for signal edge counter 1.	-												
33.35	<a href="#">Edge counter 1 warning selection</a>	Selects the warning message for signal edge counter 1.	<a href="#">Edge counter 1</a>												
	Edge counter 1	Pre-selectable warning message for signal edge counter 1.	2												
	Main contactor	Pre-selectable warning message for signal edge counter 1.	11												
	Output relay	Pre-selectable warning message for signal edge counter 1.	12												
	Motor starts	Pre-selectable warning message for signal edge counter 1.	13												

No.	Name/Value	Description	Def/FbEq16												
	Power ups	Pre-selectable warning message for signal edge counter 1.	14												
	DC-charge	Pre-selectable warning message for signal edge counter 1.	15												
33.40	<a href="#">Edge counter 2 actual</a>	Reading of signal edge counter 2. Can be reset from the Drive composer PC tool, or from the control panel by keeping Reset depressed for over 3 seconds.	-												
	0...4294967295	Reading of signal edge counter 2.	-												
33.41	<a href="#">Edge counter 2 limit</a>	Sets the warning limit for signal edge counter 2.	0												
	0...4294967295	Warning limit for signal edge counter 2.	-												
33.42	<a href="#">Edge counter 2 function</a>	Configures signal edge counter 2. This counter is incremented every time the signal selected by parameter <a href="#">33.43 Edge counter 2 source</a> switches on or off (or either, depending on the setting of this parameter). A divisor may be applied to the count (see <a href="#">33.44 Edge counter 2 divider</a> ). After the limit set by <a href="#">33.41 Edge counter 2 limit</a> is reached, the warning specified by <a href="#">33.45 Edge counter 2 warning selection</a> is given (if enabled by this parameter), and the counter reset. The current value of the counter is readable from parameter <a href="#">33.40 Edge counter 2 actual</a> . Bit 3 of <a href="#">33.01 Counter status</a> indicates that the count has exceeded the limit.	0000b												
<table border="1"> <thead> <tr> <th>Bit</th> <th>Function</th> </tr> </thead> <tbody> <tr> <td>0</td> <td>Counter mode 0 = Loop: If warning is enabled by bit 1, it stays active only for 10 seconds 1 = Saturate: If warning is enabled by bit 1, it stays active until reset</td> </tr> <tr> <td>1</td> <td>Warning enable 0 = Disable: No warning is given when the limit is reached 1 = Enable: A warning is given when the limit is reached</td> </tr> <tr> <td>2</td> <td>Count rising edges 0 = Disable: Rising edges are not counted 1 = Enable: Rising edges are counted</td> </tr> <tr> <td>3</td> <td>Count falling edges 0 = Disable: Falling edges are not counted 1 = Enable: Falling edges are counted</td> </tr> <tr> <td>4...15</td> <td>Reserved</td> </tr> </tbody> </table>				Bit	Function	0	Counter mode 0 = Loop: If warning is enabled by bit 1, it stays active only for 10 seconds 1 = Saturate: If warning is enabled by bit 1, it stays active until reset	1	Warning enable 0 = Disable: No warning is given when the limit is reached 1 = Enable: A warning is given when the limit is reached	2	Count rising edges 0 = Disable: Rising edges are not counted 1 = Enable: Rising edges are counted	3	Count falling edges 0 = Disable: Falling edges are not counted 1 = Enable: Falling edges are counted	4...15	Reserved
Bit	Function														
0	Counter mode 0 = Loop: If warning is enabled by bit 1, it stays active only for 10 seconds 1 = Saturate: If warning is enabled by bit 1, it stays active until reset														
1	Warning enable 0 = Disable: No warning is given when the limit is reached 1 = Enable: A warning is given when the limit is reached														
2	Count rising edges 0 = Disable: Rising edges are not counted 1 = Enable: Rising edges are counted														
3	Count falling edges 0 = Disable: Falling edges are not counted 1 = Enable: Falling edges are counted														
4...15	Reserved														
	0000h...FFFFh	Edge counter 2 configuration word.	1 = 1												
33.43	<a href="#">Edge counter 2 source</a>	Selects the signal to be monitored by signal edge counter 2.	<i>False</i>												
	False	0.	0												
	True	1.	1												
	RO1	Bit 0 of <a href="#">10.21 RO status</a> (page 94).	2												
	<a href="#">Other [bit]</a>	Source selection (see <a href="#">Terms and abbreviations</a> on page 81).	-												
33.44	<a href="#">Edge counter 2 divider</a>	Divisor for signal edge counter 2. Determines how many signal edges increment the counter by 1.	1												
	1...4294967295	Divisor for signal edge counter 2.	-												
33.45	<a href="#">Edge counter 2 warning selection</a>	Selects the warning message for signal edge counter 2.	<a href="#">Edge counter 2</a>												
	Edge counter 2	Pre-selectable warning message for signal edge counter 2.	3												
	Main contactor	Pre-selectable warning message for signal edge counter 2.	11												

No.	Name/Value	Description	Def/FbEq16								
	Output relay	Pre-selectable warning message for signal edge counter 2.	12								
	Motor starts	Pre-selectable warning message for signal edge counter 2.	13								
	Power ups	Pre-selectable warning message for signal edge counter 2.	14								
	DC-charge	Pre-selectable warning message for signal edge counter 2.	15								
<b>33.50</b>	<b><i>Value counter 1 actual</i></b>	Reading of value counter 1. Can be reset from the Drive composer PC tool, or from the control panel by keeping Reset depressed for over 3 seconds.	-								
	-2147483008 ... 2147483008	Reading of value counter 1.	-								
<b>33.51</b>	<b><i>Value counter 1 limit</i></b>	Sets the warning limit for value counter 1.	0								
	-2147483008 ... 2147483008	Warning limit for value counter 1.	-								
<b>33.52</b>	<b><i>Value counter 1 function</i></b>	<p>Configures value counter 1. This counter measures, by integration, the area below the signal selected by parameter <b>33.53 <i>Value counter 1 source</i></b>. A divisor may be applied to the count (see <b>33.54 <i>Value counter 1 divider</i></b>).</p> <p>When the total area exceeds the limit set by parameter <b>33.51 <i>Value counter 1 limit</i></b>, the warning specified by <b>33.55 <i>Value counter 1 warning select</i></b> is given (if enabled by this parameter).</p> <p>The signal is sampled at 1-second intervals. Note that the scaled (see the "<b>Def/FbEq16</b>" column at the signal in question) value is used.</p> <p>The current value of the counter is readable from parameter <b>33.50 <i>Value counter 1 actual</i></b>. Bit 4 of <b>33.01 <i>Counter status</i></b> indicates that the count has exceeded the limit.</p>	00b								
		<table border="1"> <thead> <tr> <th>Bit</th> <th>Function</th> </tr> </thead> <tbody> <tr> <td>0</td> <td>Counter mode 0 = Loop: If warning is enabled by bit 1, it stays active only for 10 seconds 1 = Saturate: If warning is enabled by bit 1, it stays active until reset</td> </tr> <tr> <td>1</td> <td>Warning enable 0 = Disable: No warning is given when the limit is reached 1 = Enable: A warning is given when the limit is reached</td> </tr> <tr> <td>2...15</td> <td>Reserved</td> </tr> </tbody> </table>	Bit	Function	0	Counter mode 0 = Loop: If warning is enabled by bit 1, it stays active only for 10 seconds 1 = Saturate: If warning is enabled by bit 1, it stays active until reset	1	Warning enable 0 = Disable: No warning is given when the limit is reached 1 = Enable: A warning is given when the limit is reached	2...15	Reserved	
Bit	Function										
0	Counter mode 0 = Loop: If warning is enabled by bit 1, it stays active only for 10 seconds 1 = Saturate: If warning is enabled by bit 1, it stays active until reset										
1	Warning enable 0 = Disable: No warning is given when the limit is reached 1 = Enable: A warning is given when the limit is reached										
2...15	Reserved										
	0000h...FFFFh	Value counter 1 configuration word.	1 = 1								
<b>33.53</b>	<b><i>Value counter 1 source</i></b>	Selects the signal to be monitored by value counter 1.	<i>Not selected</i>								
	Not selected	None.	0								
	Motor speed	<b>01.01 <i>Motor speed used</i></b> (see page <b>84</b> ).	1								
	Other	The value is taken from another parameter.	-								
<b>33.54</b>	<b><i>Value counter 1 divider</i></b>	Divisor for value counter 1. The value of the monitored signal is divided by this value before integration.	1.000								
	0.001 ... 2147483.647	Divisor for value counter 1.	-								
<b>33.55</b>	<b><i>Value counter 1 warning select</i></b>	Selects the warning message for value counter 1.	<i>Value 1</i>								
	Value 1	Pre-selectable warning message for value counter 1.	4								

No.	Name/Value	Description	Def/FbEq16								
	Motor bearing	Pre-selectable warning message for value counter 1.	10								
33.60	<i>Value counter 2 actual</i>	Reading of value counter 2. Can be reset from the Drive composer PC tool, or from the control panel by keeping Reset depressed for over 3 seconds.	-								
	-2147483008 ... 2147483008	Reading of value counter 2.	-								
33.61	<i>Value counter 2 limit</i>	Sets the warning limit for value counter 2.	0								
	-2147483008 ... 2147483008	Warning limit for value counter 2.	-								
33.62	<i>Value counter 2 function</i>	<p>Configures value counter 2. This counter measures, by integration, the area below the signal selected by parameter <a href="#">33.63 Value counter 2 source</a>. A divisor may be applied to the count (see <a href="#">33.64 Value counter 2 divider</a>).</p> <p>When the total area exceeds the limit set by parameter <a href="#">33.61 Value counter 2 limit</a>, the warning specified by <a href="#">33.65 Value counter 2 warning selection</a> is given (if enabled by this parameter).</p> <p>The signal is sampled at 1-second intervals. Note that the scaled (see the "FbEq" column at the signal in question) value is used.</p> <p>The current value of the counter is readable from parameter <a href="#">33.60 Value counter 2 actual</a>. Bit 5 of <a href="#">33.01 Counter status</a> indicates that the count has exceeded the limit.</p>	00b								
<table border="1"> <thead> <tr> <th>Bit</th> <th>Function</th> </tr> </thead> <tbody> <tr> <td>0</td> <td>Counter mode 0 = Loop: If warning is enabled by bit 1, it stays active only for 10 seconds 1 = Saturate: If warning is enabled by bit 1, it stays active until reset</td> </tr> <tr> <td>1</td> <td>Warning enable 0 = Disable: No warning is given when the limit is reached 1 = Enable: A warning is given when the limit is reached</td> </tr> <tr> <td>2...15</td> <td>Reserved</td> </tr> </tbody> </table>				Bit	Function	0	Counter mode 0 = Loop: If warning is enabled by bit 1, it stays active only for 10 seconds 1 = Saturate: If warning is enabled by bit 1, it stays active until reset	1	Warning enable 0 = Disable: No warning is given when the limit is reached 1 = Enable: A warning is given when the limit is reached	2...15	Reserved
Bit	Function										
0	Counter mode 0 = Loop: If warning is enabled by bit 1, it stays active only for 10 seconds 1 = Saturate: If warning is enabled by bit 1, it stays active until reset										
1	Warning enable 0 = Disable: No warning is given when the limit is reached 1 = Enable: A warning is given when the limit is reached										
2...15	Reserved										
	0000h...FFFFh	Value counter 2 configuration word.	1 = 1								
33.63	<i>Value counter 2 source</i>	Selects the signal to be monitored by value counter 2.	<i>Not selected</i>								
	Not selected	None.	0								
	Motor speed	<a href="#">01.01 Motor speed used</a> (see page 84).	1								
	Other	The value is taken from another parameter.	-								
33.64	<i>Value counter 2 divider</i>	Divisor for value counter 2. The value of the monitored signal is divided by this value before integration.	1.000								
	0.001 ... 2147483.647	Divisor for value counter 1.	-								
33.65	<i>Value counter 2 warning selection</i>	Selects the warning message for value counter 2.	<i>Value 2</i>								
	Value 2	Pre-selectable warning message for value counter 2.	5								
	Motor bearing	Pre-selectable warning message for value counter 2.	10								



No.	Name/Value	Description	Def/FbEq16
<b>35 Motor thermal protection</b>		Motor thermal protection settings. See also section <i>Motor thermal protection</i> (page 56).	
35.01	<i>Motor estimated temperature</i>	Displays the motor temperature in degrees Celsius as estimated by the motor thermal protection model (see parameters 35.50...35.55). This parameter is read-only.	-
	-60 ... 1000 °C	Estimated motor temperature.	1 = 1 °C
35.02	<i>Measured temperature 1</i>	Displays the temperature received through the source defined by parameter 35.11 <i>Supervision 1 source</i> . <b>Note:</b> With a PTC sensor, either 0 ohm (normal temperature) or the value of parameter 35.12 <i>Supervision 1 fault limit</i> (excessive temperature) is shown. This parameter is read-only.	-
	-10 ... 1000 °C or ohm	Measured temperature 1.	1 = 1 unit
35.03	<i>Measured temperature 2</i>	Displays the temperature received through the source defined by parameter 35.21 <i>Supervision 2 source</i> . <b>Note:</b> With a PTC sensor, either 0 ohm (normal temperature) or the value of parameter 35.22 <i>Supervision 2 fault limit</i> (excessive temperature) is shown. This parameter is read-only.	-
	-10 ... 1000 °C or ohm	Measured temperature 2.	1 = 1 unit
35.10	<i>Supervision 1 protection</i>	Defines the action taken by the drive when measured temperature 1 (parameter 35.02) exceeds the appropriate limits set by parameters 35.12 <i>Supervision 1 fault limit</i> and 35.13 <i>Supervision 1 warning limit</i> .	No
	No	No action.	0
	Warning	Warning <i>A491 External temperature</i> is generated when measured temperature 1 exceeds the limit set by parameter 35.13 <i>Supervision 1 warning limit</i> .	1
	Fault	Warning <i>A491 External temperature</i> is generated when measured temperature 1 exceeds the limit set by parameter 35.13 <i>Supervision 1 warning limit</i> . The drive trips on fault <i>4981 External temperature</i> when measured temperature 1 exceeds the limit set by parameter 35.12 <i>Supervision 1 fault limit</i> .	2
35.11	<i>Supervision 1 source</i>	Selects the source from which measured temperature 1 is read.	<i>Estimated temperature</i>
	Disabled	None. Temperature supervision 1 is disabled.	0
	Estimated temperature	Estimated motor temperature (see parameter 35.01 <i>Motor estimated temperature</i> ).	1

No.	Name/Value	Description	Def/FbEq16
	KTY84 StdIO / Extension module	<p>KTY84 sensor connected to the analog input selected by parameter <a href="#">35.14 Supervision 1 AI select</a> and an analog output.</p> <p>The following settings are required:</p> <ul style="list-style-type: none"> <li>• Set the hardware jumper or switch related to the analog input to <b>U</b> (voltage). Any change must be validated by a control unit reboot.</li> <li>• Set the appropriate analog input unit selection parameter in group <a href="#">12 Standard AI</a> to <b>V</b> (volt).</li> <li>• In parameter group <a href="#">13 Standard AO</a>, set the source selection parameter of the analog output to "<a href="#">Force KTY84 excitation</a>".</li> </ul> <p>The analog output feeds a constant current through the sensor. As the resistance of the sensor increases along with its temperature, the voltage over the sensor increases. The voltage is read by the analog input and converted into degrees.</p>	2
	KTY84 module 1	<p>KTY84 sensor connected to encoder interface 1. See also parameters <a href="#">91.21 Temperature meas sel1</a> and <a href="#">91.22 Temperature filtering time 1</a>.</p>	3
	KTY84 module 2	<p>KTY84 sensor connected to encoder interface 2. See also parameters <a href="#">91.24 Temperature meas sel2</a> and <a href="#">91.25 Temperature filtering time 2</a>.</p>	4
	PT100 x1 StdIO	<p>Pt100 sensor connected to the analog input selected by parameter <a href="#">35.14 Supervision 1 AI select</a> and an analog output.</p> <p>The following settings are required:</p> <ul style="list-style-type: none"> <li>• Set the hardware jumper or switch related to the analog input to <b>U</b> (voltage). Any change must be validated by a control unit reboot.</li> <li>• Set the appropriate analog input unit selection parameter in group <a href="#">12 Standard AI</a> to <b>V</b> (volt).</li> <li>• In parameter group <a href="#">13 Standard AO</a>, set the source selection parameter of the analog output to "<a href="#">Force PT100 excitation</a>".</li> </ul> <p>The analog output feeds a constant current through the sensor. As the resistance of the sensor increases along with its temperature, the voltage over the sensor increases. The voltage is read by the analog input and converted into degrees.</p>	5
	PT100 x2 StdIO	<p>As selection <a href="#">PT100 x1 StdIO</a>, but with two sensors connected in series. Using multiple sensors improves measurement accuracy significantly.</p>	6
	PT100 x3 StdIO	<p>As selection <a href="#">PT100 x1 StdIO</a>, but with three sensors connected in series. Using multiple sensors improves measurement accuracy significantly.</p>	7
	PTC DI6	<p>PTC sensor connected to digital input DI6.</p>	8
	PTC module 1	<p>PTC sensor connected to encoder interface 1. See also parameters <a href="#">91.21 Temperature meas sel1</a>, <a href="#">91.22 Temperature filtering time 1</a> and <a href="#">91.23 PTC filtering 1</a>.</p>	9
	PTC module 2	<p>PTC sensor connected to encoder interface 2. See also parameters <a href="#">91.24 Temperature meas sel2</a>, <a href="#">91.25 Temperature filtering time 2</a> and <a href="#">91.26 PTC filtering 2</a>.</p>	10

No.	Name/Value	Description	Def/FbEq16
	Direct temperature	The temperature is taken from the source selected by parameter <a href="#">35.14 Supervision 1 AI select</a> . The value of the source is assumed to be degrees Celsius.	11
<a href="#">35.12</a>	<a href="#">Supervision 1 fault limit</a>	Defines the fault limit for temperature supervision 1. See parameter <a href="#">35.10 Supervision 1 protection</a> . <b>Note:</b> With a PTC sensor, the unit is ohm.	130 °C
	-10 ... 1000 °C or ohm	Fault limit for temperature supervision 1.	1 = 1 unit
<a href="#">35.13</a>	<a href="#">Supervision 1 warning limit</a>	Defines the warning limit for temperature supervision 1. See parameter <a href="#">35.10 Supervision 1 protection</a> . <b>Note:</b> With a PTC sensor, the unit is ohm.	110 °C
	-10 ... 1000 °C or ohm	Warning limit for temperature supervision 1.	1 = 1 unit
<a href="#">35.14</a>	<a href="#">Supervision 1 AI select</a>	Selects the input for parameter <a href="#">35.11 Supervision 1 source</a> , selections <a href="#">KTY84 StdIO / Extension module</a> , <a href="#">PT100 x1 StdIO</a> , <a href="#">PT100 x2 StdIO</a> , <a href="#">PT100 x3 StdIO</a> and <a href="#">Direct temperature</a> .	<i>Not selected</i>
	Not selected	None.	0
	AI1 actual value	Analog input AI1 on the control unit.	1
	AI2 actual value	Analog input AI2 on the control unit.	2
	Other	The value is taken from another parameter.	-
<a href="#">35.20</a>	<a href="#">Supervision 2 protection</a>	Defines the action taken by the drive when measured temperature 2 (parameter <a href="#">35.03</a> ) exceeds the appropriate limits set by parameters <a href="#">35.22 Supervision 2 fault limit</a> and <a href="#">35.23 Supervision 2 warning limit</a> .	<i>No</i>
	No	No action.	0
	Warning	Warning <a href="#">A491 External temperature</a> is generated when measured temperature 2 exceeds the limit set by parameter <a href="#">35.23 Supervision 2 warning limit</a> .	1
	Fault	Warning <a href="#">A491 External temperature</a> is generated when measured temperature 2 exceeds the limit set by parameter <a href="#">35.23 Supervision 2 warning limit</a> . The drive trips on fault <a href="#">4981 External temperature</a> when measured temperature 2 exceeds the limit set by parameter <a href="#">35.22 Supervision 2 fault limit</a> .	2
<a href="#">35.21</a>	<a href="#">Supervision 2 source</a>	Selects the source from which measured temperature 2 is read.	
	Disabled	None. Temperature supervision 2 is disabled.	0
	Estimated temperature	Estimated motor temperature (see parameter <a href="#">35.01 Motor estimated temperature</a> ).	1

No.	Name/Value	Description	Def/FbEq16
	KTY84 StdIO / Extension module	<p>KTY84 sensor connected to the analog input selected by parameter <a href="#">35.24 Supervision 2 AI select</a> and an analog output.</p> <p>The following settings are required:</p> <ul style="list-style-type: none"> <li>• Set the hardware jumper or switch related to the analog input to <b>U</b> (voltage). Any change must be validated by a control unit reboot.</li> <li>• Set the appropriate analog input unit selection parameter in group <a href="#">12 Standard AI</a> to <b>V</b> (volt).</li> <li>• In parameter group <a href="#">13 Standard AO</a>, set the source selection parameter of the analog output to “<a href="#">Force KTY84 excitation</a>”.</li> </ul> <p>The analog output feeds a constant current through the sensor. As the resistance of the sensor increases along with its temperature, the voltage over the sensor increases. The voltage is read by the analog input and converted into degrees.</p>	2
	KTY84 module 1	<p>KTY84 sensor connected to encoder interface 1. See also parameters <a href="#">91.21 Temperature meas sel1</a> and <a href="#">91.22 Temperature filtering time 1</a>.</p>	3
	KTY84 module 2	<p>KTY84 sensor connected to encoder interface 2. See also parameters <a href="#">91.24 Temperature meas sel2</a> and <a href="#">91.25 Temperature filtering time 2</a>.</p>	4
	PT100 x1 StdIO	<p>Pt100 sensor connected to the analog input selected by parameter <a href="#">35.24 Supervision 2 AI select</a> and an analog output.</p> <p>The following settings are required:</p> <ul style="list-style-type: none"> <li>• Set the hardware jumper or switch related to the analog input to <b>U</b> (voltage). Any change must be validated by a control unit reboot.</li> <li>• Set the appropriate analog input unit selection parameter in group <a href="#">12 Standard AI</a> to <b>V</b> (volt).</li> <li>• In parameter group <a href="#">13 Standard AO</a>, set the source selection parameter of the analog output to “<a href="#">Force PT100 excitation</a>”.</li> </ul> <p>The analog output feeds a constant current through the sensor. As the resistance of the sensor increases along with its temperature, the voltage over the sensor increases. The voltage is read by the analog input and converted into degrees.</p>	5
	PT100 x2 StdIO	<p>As selection <a href="#">PT100 x1 StdIO</a>, but with two sensors connected in series. Using multiple sensors improves measurement accuracy significantly.</p>	6
	PT100 x3 StdIO	<p>As selection <a href="#">PT100 x1 StdIO</a>, but with three sensors connected in series. Using multiple sensors improves measurement accuracy significantly.</p>	7
	PTC DI6	<p>PTC sensor connected to digital input DI6.</p>	8
	PTC module 1	<p>PTC sensor connected to encoder interface 1. See also parameters <a href="#">91.21 Temperature meas sel1</a>, <a href="#">91.22 Temperature filtering time 1</a> and <a href="#">91.23 PTC filtering 1</a>.</p>	9
	PTC module 2	<p>PTC sensor connected to encoder interface 2. See also parameters <a href="#">91.24 Temperature meas sel2</a>, <a href="#">91.25 Temperature filtering time 2</a> and <a href="#">91.26 PTC filtering 2</a>.</p>	10

No.	Name/Value	Description	Def/FbEq16
	Direct temperature	The temperature is taken from the source selected by parameter <a href="#">35.24 Supervision 2 AI select</a> . The value of the source is assumed to be degrees Celsius.	11
<a href="#">35.22</a>	<a href="#">Supervision 2 fault limit</a>	Defines the fault limit for temperature supervision 2. See parameter <a href="#">35.20 Supervision 2 protection</a> . <b>Note:</b> With a PTC sensor, the unit is ohm.	130 °C
	-10 ... 1000 °C or ohm	Fault limit for temperature supervision 2.	1 = 1 unit
<a href="#">35.23</a>	<a href="#">Supervision 2 warning limit</a>	Defines the warning limit for temperature supervision 2. See parameter <a href="#">35.20 Supervision 2 protection</a> . <b>Note:</b> With a PTC sensor, the unit is ohm.	110 °C
	-10 ... 1000 °C or ohm	Warning limit for temperature supervision 2.	1 = 1 unit
<a href="#">35.24</a>	<a href="#">Supervision 2 AI select</a>	Selects the input for parameter <a href="#">35.21 Supervision 2 source</a> , selections <a href="#">KTY84 StdIO / Extension module</a> , <a href="#">PT100 x1 StdIO</a> , <a href="#">PT100 x2 StdIO</a> , <a href="#">PT100 x3 StdIO</a> and <a href="#">Direct temperature</a> .	<i>Not selected</i>
	Not selected	None.	0
	AI1 actual value	Analog input AI1 on the control unit.	1
	AI2 actual value	Analog input AI2 on the control unit.	2
	Other	The value is taken from another parameter.	-
<a href="#">35.50</a>	<a href="#">Motor ambient temperature</a>	Defines the ambient temperature of the motor (in °C) for the motor thermal protection model. The motor thermal protection model estimates the motor temperature on the basis of the parameters in this group. The motor temperature increases if it operates in the region above the load curve, and decreases if it operates in the region below the load curve (if the motor is overheated).  <b>WARNING!</b> The model cannot protect the motor if it does not cool properly because of dust, dirt, etc.	20 °C
	-60 ... 100 °C	Ambient temperature.	1 = 1 °C

No.	Name/Value	Description	Def/FbEq16
35.51	<i>Motor load curve</i>	<p>Defines the motor load curve together with parameters <a href="#">35.52 Zero speed load</a> and <a href="#">35.53 Break point</a>. The load curve is used by the motor thermal protection model to estimate the motor temperature.</p> <p>When the parameter is set to 100%, the maximum load is equal to the value of parameter <a href="#">99.06 Motor nominal current</a> (higher loads heat up the motor). The load curve level should be adjusted if the ambient temperature differs from the nominal value.</p>	100%
<p>The graph plots the ratio of motor current to nominal motor current, <math>I/I_N</math> (%), on the vertical axis against the drive output frequency on the horizontal axis. The vertical axis has tick marks at 50, 100, and 150. The horizontal axis has a tick mark at 35.53. The curve begins at a value of 35.52 on the vertical axis when the frequency is zero. It rises linearly to a value of 100 at a frequency of 35.53. From this point, the curve continues as a horizontal line at 100% for all higher frequencies. A legend indicates that <math>I</math> is the motor current and <math>I_N</math> is the nominal motor current.</p>			
	50 ... 150%	Maximum load for the motor load curve.	1 = 1%
35.52	<i>Zero speed load</i>	<p>Defines the motor load curve together with parameters <a href="#">35.51 Motor load curve</a> and <a href="#">35.53 Break point</a>. Defines the maximum motor load at zero speed of the load curve. A higher value can be used if the motor has an external motor fan to boost the cooling. See the motor manufacturer's recommendations.</p> <p>See parameter <a href="#">35.51 Motor load curve</a>.</p>	100%
	50 ... 150%	Zero speed load for the motor load curve.	1 = 1%
35.53	<i>Break point</i>	<p>Defines the motor load curve together with parameters <a href="#">35.51 Motor load curve</a> and <a href="#">35.52 Zero speed load</a>. Defines the break point frequency of the load curve i.e. the point at which the motor load curve begins to decrease from the value of parameter <a href="#">35.51 Motor load curve</a> towards the value of parameter <a href="#">35.52 Zero speed load</a>.</p> <p>See parameter <a href="#">35.51 Motor load curve</a>.</p>	45.00 Hz
	1.00 ... 500.00 Hz	Break point for the motor load curve.	See par. <a href="#">46.02</a>

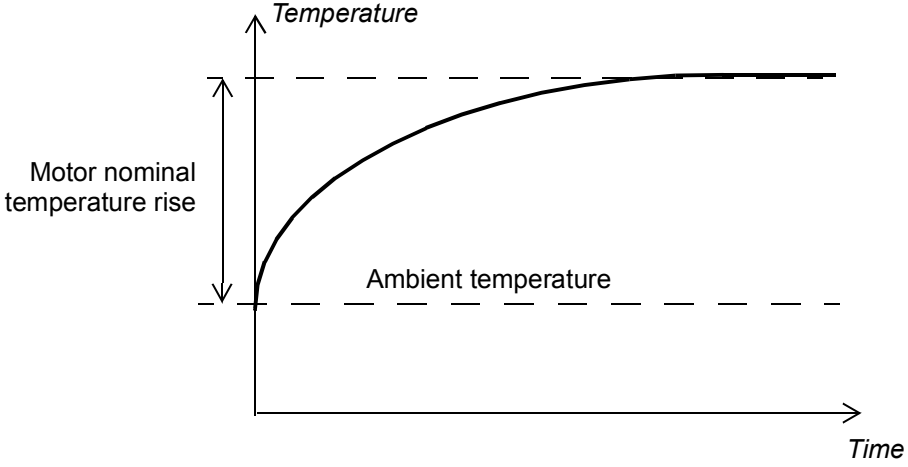
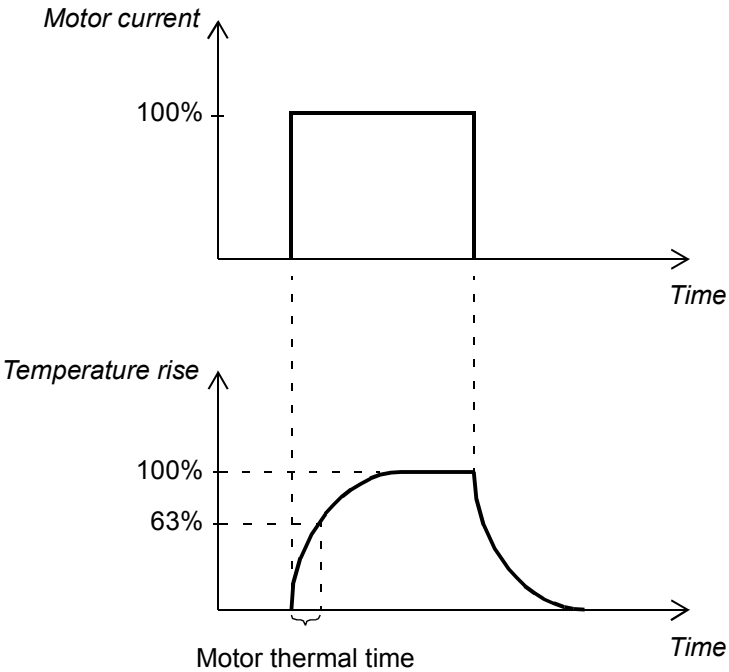
No.	Name/Value	Description	Def/FbEq16
35.54	<i>Motor nominal temp rise</i>	Defines the temperature rise of the motor when the motor is loaded with nominal current. See the motor manufacturer's recommendations.	80 °C
			
0 ... 300 °C	Temperature rise.	1 = 1 °C	
35.55	<i>Motor thermal time const</i>	Defines the thermal time constant for the motor thermal protection model (i.e. time inside which the temperature has reached 63% of the nominal temperature). See the motor manufacturer's recommendations.	256 s
			
100 ... 10000 s	Motor thermal time constant.	1 = 1 s	

No.	Name/Value	Description	Def/FbEq16
<b>36 Load analyzer</b>		Peak value and amplitude logger settings. See also section <a href="#">Load analyzer</a> (page 62).	
<b>36.01</b>	<b><i>PVL signal</i></b>	Selects the signal to be monitored by the peak value logger. The signal is filtered using the filtering time specified by parameter <a href="#">36.02 PVL filter time</a> . The peak value is stored, along with other pre-selected signals at the time, into parameters <a href="#">36.10...36.15</a> . The peak value logger can be reset using parameter <a href="#">36.09 Reset loggers</a> . The date and time of the last reset are stored into parameters <a href="#">36.16</a> and <a href="#">36.17</a> respectively.	<b><i>Power inu out</i></b>
	Zero	None (peak value logger disabled).	0
	Motor speed used	<a href="#">01.01 Motor speed used</a> (page 84).	1
	Output frequency	<a href="#">01.06 Output frequency</a> (page 84).	3
	Motor current	<a href="#">01.07 Motor current</a> (page 84).	4
	Motor torque	<a href="#">01.10 Motor torque %</a> (page 84).	6
	Dc-voltage	<a href="#">01.11 DC voltage</a> (page 84).	7
	Power inu out	<a href="#">01.14 Output power</a> (page 84).	8
	Speed ref ramp in	<a href="#">23.01 Speed ref ramp in</a> (page 151).	10
	Speed ref ramped	<a href="#">23.02 Speed ref ramp out</a> (page 151).	11
	Speed ref used	<a href="#">24.01 Used speed reference</a> (page 155).	12
	Torq ref used	<a href="#">26.02 Torque ref used</a> (page 164).	13
	Freq ref used	<a href="#">28.02 Frequency ref ramp out</a> (page 168).	14
	Process PID out	<a href="#">40.01 Process PID actual value</a> (page 203).	16
	Process PID fbk	<a href="#">40.02 Feedback actual value</a> (page 203).	17
	Process PID act	<a href="#">40.03 Setpoint actual value</a> (page 203).	18
	Process PID dev	<a href="#">40.04 Deviation actual value</a> (page 203).	19
	Other	The value is taken from another parameter.	-
<b>36.02</b>	<b><i>PVL filter time</i></b>	Peak value logger filtering time. See parameter <a href="#">36.01 PVL signal</a> .	2.00 s
	0.00 ... 120.00 s	Peak value logger filtering time.	100 = 1 s
<b>36.06</b>	<b><i>AL2 signal</i></b>	Selects the signal to be monitored by amplitude logger 2. The signal is sampled at 200-millisecond intervals when the drive is running. The results are displayed by parameters <a href="#">36.40...36.49</a> . Each parameter represents an amplitude range, and shows what portion of the samples fall within that range. The signal value corresponding to 100% is defined by parameter <a href="#">36.07 AL2 signal base</a> . Amplitude logger 2 can be reset using parameter <a href="#">36.09 Reset loggers</a> . The date and time of the last reset are stored into parameters <a href="#">36.50</a> and <a href="#">36.51</a> respectively. For the selections, see parameter <a href="#">36.01 PVL signal</a> .	<b><i>Motor torque</i></b>
<b>36.07</b>	<b><i>AL2 signal base</i></b>	Defines the signal value that corresponds to 100% amplitude.	100.00
	0.00 ... 32767.00	Signal value corresponding to 100%.	1 = 1
<b>36.09</b>	<b><i>Reset loggers</i></b>	Resets the peak value logger and/or amplitude logger 2. (Amplitude logger 1 cannot be reset.)	<b><i>Done</i></b>
	Done	Reset completed or not requested (normal operation).	0



No.	Name/Value	Description	Def/FbEq16
	All	Reset both the peak value logger and amplitude logger 2.	1
	PVL	Reset the peak value logger.	2
	AL2	Reset amplitude logger 2.	3
<a href="#">36.10</a>	<a href="#">PVL peak value</a>	Peak value recorded by the peak value logger.	0.00
	-32768.00 ... 32767.00	Peak value.	1 = 1
<a href="#">36.11</a>	<a href="#">PVL peak date</a>	The date on which the peak value was recorded.	-
	-	Peak occurrence date.	-
<a href="#">36.12</a>	<a href="#">PVL peak time</a>	The time at which the peak value was recorded.	-
	-	Peak occurrence time.	-
<a href="#">36.13</a>	<a href="#">PVL current at peak</a>	Motor current at the moment the peak value was recorded.	0.00 A
	-32768.00 ... 32767.00 A	Motor current at peak.	1 = 1 A
<a href="#">36.14</a>	<a href="#">PVL DC voltage at peak</a>	Voltage in the intermediate DC circuit of the drive at the moment the peak value was recorded.	0.00 V
	0.00 ... 2000.00 V	DC voltage at peak.	10 = 1 V
<a href="#">36.15</a>	<a href="#">PVL speed at peak</a>	Motor speed at the moment the peak value was recorded.	0.00 rpm
	-32768.00 ... 32767.00 rpm	Motor speed at peak.	See par. <a href="#">46.01</a>
<a href="#">36.16</a>	<a href="#">PVL reset date</a>	The date on which the peak value logger was last reset.	-
	-	Last reset date of the peak value logger.	-
<a href="#">36.17</a>	<a href="#">PVL reset time</a>	The time at which the peak value logger was last reset.	-
	-	Last reset time of the peak value logger.	-
<a href="#">36.20</a>	<a href="#">AL1 0 to 10%</a>	Percentage of samples recorded by amplitude logger 1 that fall between 0 and 10%.	0.00%
	0.00 ... 100.00%	Amplitude logger 1 samples between 0 and 10%.	1 = 1%
<a href="#">36.21</a>	<a href="#">AL1 10 to 20%</a>	Percentage of samples recorded by amplitude logger 1 that fall between 10 and 20%.	0.00%
	0.00 ... 100.00%	Amplitude logger 1 samples between 10 and 20%.	1 = 1%
<a href="#">36.22</a>	<a href="#">AL1 20 to 30%</a>	Percentage of samples recorded by amplitude logger 1 that fall between 20 and 30%.	0.00%
	0.00 ... 100.00%	Amplitude logger 1 samples between 20 and 30%.	1 = 1%
<a href="#">36.23</a>	<a href="#">AL1 30 to 40%</a>	Percentage of samples recorded by amplitude logger 1 that fall between 30 and 40%.	0.00%
	0.00 ... 100.00%	Amplitude logger 1 samples between 30 and 40%.	1 = 1%
<a href="#">36.24</a>	<a href="#">AL1 40 to 50%</a>	Percentage of samples recorded by amplitude logger 1 that fall between 40 and 50%.	0.00%
	0.00 ... 100.00%	Amplitude logger 1 samples between 40 and 50%.	1 = 1%
<a href="#">36.25</a>	<a href="#">AL1 50 to 60%</a>	Percentage of samples recorded by amplitude logger 1 that fall between 50 and 60%.	0.00%
	0.00 ... 100.00%	Amplitude logger 1 samples between 50 and 60%.	1 = 1%
<a href="#">36.26</a>	<a href="#">AL1 60 to 70%</a>	Percentage of samples recorded by amplitude logger 1 that fall between 60 and 70%.	0.00%
	0.00 ... 100.00%	Amplitude logger 1 samples between 60 and 70%.	1 = 1%

## 202 Parameters

No.	Name/Value	Description	Def/FbEq16
36.27	<i>AL1 70 to 80%</i>	Percentage of samples recorded by amplitude logger 1 that fall between 70 and 80%.	0.00%
	0.00 ... 100.00%	Amplitude logger 1 samples between 70 and 80%.	1 = 1%
36.28	<i>AL1 80 to 90%</i>	Percentage of samples recorded by amplitude logger 1 that fall between 80 and 90%.	0.00%
	0.00 ... 100.00%	Amplitude logger 1 samples between 80 and 90%.	1 = 1%
36.29	<i>AL1 over 90%</i>	Percentage of samples recorded by amplitude logger 1 that exceed 90%.	0.00%
	0.00 ... 100.00%	Amplitude logger 1 samples over 90%.	1 = 1%
36.40	<i>AL2 0 to 10%</i>	Percentage of samples recorded by amplitude logger 2 that fall between 0 and 10%.	0.00%
	0.00 ... 100.00%	Amplitude logger 2 samples between 0 and 10%.	1 = 1%
36.41	<i>AL2 10 to 20%</i>	Percentage of samples recorded by amplitude logger 2 that fall between 10 and 20%.	0.00%
	0.00 ... 100.00%	Amplitude logger 2 samples between 10 and 20%.	1 = 1%
36.42	<i>AL2 20 to 30%</i>	Percentage of samples recorded by amplitude logger 2 that fall between 20 and 30%.	0.00%
	0.00 ... 100.00%	Amplitude logger 2 samples between 20 and 30%.	1 = 1%
36.43	<i>AL2 30 to 40%</i>	Percentage of samples recorded by amplitude logger 2 that fall between 30 and 40%.	0.00%
	0.00 ... 100.00%	Amplitude logger 2 samples between 30 and 40%.	1 = 1%
36.44	<i>AL2 40 to 50%</i>	Percentage of samples recorded by amplitude logger 2 that fall between 40 and 50%.	0.00%
	0.00 ... 100.00%	Amplitude logger 2 samples between 40 and 50%.	1 = 1%
36.45	<i>AL2 50 to 60%</i>	Percentage of samples recorded by amplitude logger 2 that fall between 50 and 60%.	0.00%
	0.00 ... 100.00%	Amplitude logger 2 samples between 50 and 60%.	1 = 1%
36.46	<i>AL2 60 to 70%</i>	Percentage of samples recorded by amplitude logger 2 that fall between 60 and 70%.	0.00%
	0.00 ... 100.00%	Amplitude logger 2 samples between 60 and 70%.	1 = 1%
36.47	<i>AL2 70 to 80%</i>	Percentage of samples recorded by amplitude logger 2 that fall between 70 and 80%.	0.00%
	0.00 ... 100.00%	Amplitude logger 2 samples between 70 and 80%.	1 = 1%
36.48	<i>AL2 80 to 90%</i>	Percentage of samples recorded by amplitude logger 2 that fall between 80 and 90%.	0.00%
	0.00 ... 100.00%	Amplitude logger 2 samples between 80 and 90%.	1 = 1%
36.49	<i>AL2 over 90%</i>	Percentage of samples recorded by amplitude logger 2 that exceed 90%.	0.00%
	0.00 ... 100.00%	Amplitude logger 2 samples over 90%.	1 = 1%
36.50	<i>AL2 reset date</i>	The date on which amplitude logger 2 was last reset.	-
	-	Last reset date of amplitude logger 2.	-
36.51	<i>AL2 reset time</i>	The time at which amplitude logger 2 was last reset.	-
	-	Last reset time of amplitude logger 2.	-

No.	Name/Value	Description	Def/FbEq16
<b>40 Process PID set 1</b>		<p>Parameter values for process PID control.</p> <p>Two different sets of parameter values can be pre-defined. The first set is made up of parameters <a href="#">40.07...40.56*</a>, the second set is defined by the parameters in group <a href="#">41 Process PID set 2</a>. The binary source that defines which set is used is selected by parameter <a href="#">40.57 Sel between set1 set2</a>.</p> <p>See also the control chain diagrams on pages <a href="#">360</a> and <a href="#">361</a>.</p> <p>*The remaining parameters in this group are common for both sets.</p>	
40.01	<i>Process PID actual value</i>	<p>Displays the output of the process PID controller. See the control chain diagram on page <a href="#">361</a>.</p> <p>This parameter is read-only. The unit is selected by parameter <a href="#">40.12 Unit selection</a>.</p>	-
	-32768 ... 32767	Process PID controller output.	1 = 1 unit
40.02	<i>Feedback actual value</i>	<p>Displays the value of process feedback after source selection, mathematical function (parameter <a href="#">40.10 Feedback function</a>), and filtering. See the control chain diagram on page <a href="#">360</a>.</p> <p>This parameter is read-only. The unit is selected by parameter <a href="#">40.12 Unit selection</a>.</p>	-
	-32768 ... 32767	Process feedback.	1 = 1 unit
40.03	<i>Setpoint actual value</i>	<p>Displays the value of process PID setpoint after source selection, mathematical function (<a href="#">40.18 Setpoint function</a>), limitation and ramping. See the control chain diagram on page <a href="#">361</a>.</p> <p>This parameter is read-only. The unit is selected by parameter <a href="#">40.12 Unit selection</a>.</p>	-
	-32768 ... 32767	Setpoint for process PID controller.	1 = 1 unit
40.04	<i>Deviation actual value</i>	<p>Displays the process PID deviation. By default, this value equals setpoint - feedback, but deviation can be inverted by parameter <a href="#">40.31 Deviation inversion</a>. See the control chain diagram on page <a href="#">361</a>.</p> <p>This parameter is read-only. The unit is selected by parameter <a href="#">40.12 Unit selection</a>.</p>	-
	-32768 ... 32767	PID deviation.	1 = 1 unit
40.05	<i>Trim output actual value</i>	<p>Displays the trimmed reference output. See the control chain diagram on page <a href="#">361</a>.</p> <p>This parameter is read-only. The unit is selected by parameter <a href="#">40.12 Unit selection</a>.</p>	-
	-32768 ... 32767	Trimmed reference.	1 = 1 unit

No.	Name/Value	Description	Def/FbEq16																																							
40.06	<i>PID status word</i>	Displays status information on process PID control. This parameter is read-only.	-																																							
		<table border="1"> <thead> <tr> <th>Bit</th> <th>Name</th> <th>Value</th> </tr> </thead> <tbody> <tr> <td>0</td> <td>PID active</td> <td>1 = Process PID control active.</td> </tr> <tr> <td>1</td> <td>Setpoint frozen</td> <td>1 = Process PID setpoint frozen.</td> </tr> <tr> <td>2</td> <td>Output frozen</td> <td>1 = Process PID controller output frozen.</td> </tr> <tr> <td>3</td> <td>PID sleep mode</td> <td>1 = Sleep mode active.</td> </tr> <tr> <td>4</td> <td>Sleep boost</td> <td>1 = Sleep boost active.</td> </tr> <tr> <td>5</td> <td>Trim mode</td> <td>1 = Trim function active.</td> </tr> <tr> <td>6</td> <td>Tracking mode</td> <td>1 = Tracking function active.</td> </tr> <tr> <td>7</td> <td>Output limit high</td> <td>1 = PID output is being limited by par. <a href="#">40.37</a>.</td> </tr> <tr> <td>8</td> <td>Output limit low</td> <td>1 = PID output is being limited by par. <a href="#">40.36</a>.</td> </tr> <tr> <td>9</td> <td>Deadband active</td> <td>1 = Deadband active (see par. <a href="#">40.39</a>)</td> </tr> <tr> <td>10</td> <td>PID set</td> <td>0 = Parameter set 1 in use. 1 = Parameter set 2 in use.</td> </tr> <tr> <td>11...15</td> <td>Reserved</td> <td></td> </tr> </tbody> </table>	Bit	Name	Value	0	PID active	1 = Process PID control active.	1	Setpoint frozen	1 = Process PID setpoint frozen.	2	Output frozen	1 = Process PID controller output frozen.	3	PID sleep mode	1 = Sleep mode active.	4	Sleep boost	1 = Sleep boost active.	5	Trim mode	1 = Trim function active.	6	Tracking mode	1 = Tracking function active.	7	Output limit high	1 = PID output is being limited by par. <a href="#">40.37</a> .	8	Output limit low	1 = PID output is being limited by par. <a href="#">40.36</a> .	9	Deadband active	1 = Deadband active (see par. <a href="#">40.39</a> )	10	PID set	0 = Parameter set 1 in use. 1 = Parameter set 2 in use.	11...15	Reserved		
Bit	Name	Value																																								
0	PID active	1 = Process PID control active.																																								
1	Setpoint frozen	1 = Process PID setpoint frozen.																																								
2	Output frozen	1 = Process PID controller output frozen.																																								
3	PID sleep mode	1 = Sleep mode active.																																								
4	Sleep boost	1 = Sleep boost active.																																								
5	Trim mode	1 = Trim function active.																																								
6	Tracking mode	1 = Tracking function active.																																								
7	Output limit high	1 = PID output is being limited by par. <a href="#">40.37</a> .																																								
8	Output limit low	1 = PID output is being limited by par. <a href="#">40.36</a> .																																								
9	Deadband active	1 = Deadband active (see par. <a href="#">40.39</a> )																																								
10	PID set	0 = Parameter set 1 in use. 1 = Parameter set 2 in use.																																								
11...15	Reserved																																									
	0000h...FFFFh	Process PID control status word.	1 = 1																																							
40.07	<i>PID operation mode</i>	Activates/deactivates process PID control. <b>Note:</b> Process PID control is only available in external control; see section <a href="#">Local control vs. external control</a> (page <a href="#">18</a> ).	<i>Off</i>																																							
	Off	Process PID control inactive.	0																																							
	On	Process PID control active.	1																																							
	On when drive running	Process PID control is active when the drive is running.	2																																							
40.08	<i>Feedback 1 source</i>	Selects the first source of process feedback. See the control chain diagram on page <a href="#">360</a> .	<i>AI1 scaled</i>																																							
	Zero	Zero feedback.	0																																							
	AI1 scaled	<a href="#">12.12 AI1 scaled value</a> (see page <a href="#">102</a> ).	1																																							
	AI2 scaled	<a href="#">12.22 AI2 scaled value</a> (see page <a href="#">103</a> ).	2																																							
	Freq in scaled	<a href="#">11.39 Freq in 1 scaled</a> (see page <a href="#">99</a> ).	3																																							
	Motor current	<a href="#">01.07 Motor current</a> (see page <a href="#">84</a> ).	5																																							
	Power inu out	<a href="#">01.14 Output power</a> (see page <a href="#">84</a> ).	6																																							
	Motor torque	<a href="#">01.10 Motor torque %</a> (see page <a href="#">84</a> ).	7																																							
	Other	The value is taken from another parameter.	-																																							
40.09	<i>Feedback 2 source</i>	Selects the second source of process feedback. For the selections, see parameter <a href="#">40.08 Feedback 1 source</a> .	<i>Zero</i>																																							
40.10	<i>Feedback function</i>	Defines how process feedback is calculated from the two sources selected by parameters <a href="#">40.08 Feedback 1 source</a> and <a href="#">40.09 Feedback 2 source</a> .	<i>In1</i>																																							
	In1	Source 1.	0																																							
	In1+In2	Sum of sources 1 and 2.	1																																							
	In1-In2	Source 2 subtracted from source 1.	2																																							
	In1*In2	Source 1 multiplied by source 2.	3																																							
	In1/In2	Source 1 divided by source 2.	4																																							

No.	Name/Value	Description	Def/FbEq16
	MIN(ln1,ln2)	Smaller of the two sources.	5
	MAX(ln1,ln2)	Greater of the two sources.	6
	AVE(ln1,ln2)	Average of the two sources.	7
	sqrt(ln1)	Square root of source 1.	8
	sqrt(ln1-ln2)	Square root of (source 1 - source 2).	9
	sqrt(ln1+ln2)	Square root of (source 1 + source 2).	10
	sqrt(ln1)+sqrt(ln2)	Square root of source 1 + square root of source 2.	11
<b>40.11</b>	<b>Feedback filter time</b>	Defines the filter time constant for process feedback.	0.000 s
	0.000 ... 30.000 s	Feedback filter time.	1 = 1 s
<b>40.12</b>	<b>Unit selection</b>	Defines the unit for parameters <a href="#">40.01...40.05</a> , <a href="#">40.21...40.24</a> and <a href="#">40.47</a> .	<i>rpm</i>
	rpm	rpm.	7
	%	%.	4
	Hz	Hz.	3
<b>40.14</b>	<b>Setpoint base</b>	Defines, together with parameter <a href="#">40.15 Output base</a> , a general scaling factor for the process PID control chain. The scaling can be utilized when, for example, the process setpoint is input in Hz, and the output of the PID controller is used as an rpm value in speed control. In this case, this parameter might be set to 50, and parameter <a href="#">40.15</a> to the nominal motor speed at 50 Hz. In effect, the output of the PID controller = [ <a href="#">40.15</a> ] when deviation (setpoint - feedback) = [ <a href="#">40.14</a> ] and [ <a href="#">40.32</a> ] = 1. <b>Note:</b> The scaling is based on the ratio between <a href="#">40.14</a> and <a href="#">40.15</a> . For example, the values 50 and 1500 would produce the same scaling as 1 and 30.	1500
	-32768 ... 32767	Process setpoint base.	1 = 1
<b>40.15</b>	<b>Output base</b>	See parameter <a href="#">40.14 Setpoint base</a> .	1500
	-32768 ... 32767	Process PID controller output base.	1 = 1
<b>40.16</b>	<b>Setpoint 1 source</b>	Selects the first source of process PID setpoint. This setpoint is available in parameter <a href="#">40.25 Setpoint selection</a> as setpoint 1. See the control chain diagram on page <a href="#">360</a> .	<i>AI2 scaled</i>
	Zero	Zero.	0
	Control panel	<a href="#">03.01 Panel reference</a> (see page <a href="#">85</a> ).	1
	Internal setpoint	Internal setpoint. See parameter <a href="#">40.19 Internal setpoint selection 1</a> .	2
	AI1 scaled	<a href="#">12.12 AI1 scaled value</a> (see page <a href="#">102</a> ).	3
	AI2 scaled	<a href="#">12.22 AI2 scaled value</a> (see page <a href="#">103</a> ).	4
	Freq in scaled	<a href="#">11.39 Freq in 1 scaled</a> (see page <a href="#">99</a> ).	10
	Other	The value is taken from another parameter.	-
<b>40.17</b>	<b>Setpoint 2 source</b>	Selects the second source of process setpoint. This setpoint is available in parameter <a href="#">40.25 Setpoint selection</a> as setpoint 2. For the selections, see parameter <a href="#">40.16 Setpoint 1 source</a> .	<i>Zero</i>

No.	Name/Value	Description	Def/FbEq16															
40.18	<i>Setpoint function</i>	Selects a mathematical function between the setpoint sources selected by parameters <i>40.16 Setpoint 1 source</i> and <i>40.17 Setpoint 2 source</i> .	<i>In1 or In2</i>															
	In1 or In2	No mathematical function applied. The source selected by parameter <i>40.25 Setpoint selection</i> is used.	0															
	In1+In2	Sum of sources 1 and 2.	1															
	In1-In2	Source 2 subtracted from source 1.	2															
	In1*In2	Source 1 multiplied by source 2.	3															
	In1/In2	Source 1 divided by source 2.	4															
	MIN(In1,In2)	Smaller of the two sources.	5															
	MAX(In1,In2)	Greater of the two sources.	6															
	AVE(In1,In2)	Average of the two sources.	7															
	sqrt(In1)	Square root of source 1.	8															
	sqrt(In1-In2)	Square root of (source 1 - source 2).	9															
	sqrt(In1+In2)	Square root of (source 1 + source 2).	10															
	sqrt(In1)+sqrt(In2)	Square root of source 1 + square root of source 2.	11															
40.19	<i>Internal setpoint selection 1</i>	Selects, together with <i>40.20 Internal setpoint selection 2</i> , the internal setpoint out of the presets defined by parameters <i>40.21...40.24</i> .	<i>Not selected</i>															
<table border="1"> <thead> <tr> <th>Source defined by par. 40.19</th> <th>Source defined by par. 40.20</th> <th>Setpoint preset active</th> </tr> </thead> <tbody> <tr> <td>0</td> <td>0</td> <td>1 (par. 40.21)</td> </tr> <tr> <td>1</td> <td>0</td> <td>2 (par. 40.22)</td> </tr> <tr> <td>0</td> <td>1</td> <td>3 (par. 40.23)</td> </tr> <tr> <td>1</td> <td>1</td> <td>4 (par. 40.24)</td> </tr> </tbody> </table>				Source defined by par. 40.19	Source defined by par. 40.20	Setpoint preset active	0	0	1 (par. 40.21)	1	0	2 (par. 40.22)	0	1	3 (par. 40.23)	1	1	4 (par. 40.24)
Source defined by par. 40.19	Source defined by par. 40.20	Setpoint preset active																
0	0	1 (par. 40.21)																
1	0	2 (par. 40.22)																
0	1	3 (par. 40.23)																
1	1	4 (par. 40.24)																
	Not selected	0.	0															
	Selected	1.	1															
	DI1	Digital input DI1 ( <i>10.02 DI delayed status</i> , bit 0).	2															
	DI2	Digital input DI2 ( <i>10.02 DI delayed status</i> , bit 1).	3															
	DI3	Digital input DI3 ( <i>10.02 DI delayed status</i> , bit 2).	4															
	DI4	Digital input DI4 ( <i>10.02 DI delayed status</i> , bit 3).	5															
	DI5	Digital input DI5 ( <i>10.02 DI delayed status</i> , bit 4).	6															
	DI6	Digital input DI6 ( <i>10.02 DI delayed status</i> , bit 5).	7															
	DIO1	Digital input/output DIO1 ( <i>11.02 DIO delayed status</i> , bit 0).	10															
	DIO2	Digital input/output DIO2 ( <i>11.02 DIO delayed status</i> , bit 1).	11															
	<i>Other [bit]</i>	Source selection (see <i>Terms and abbreviations</i> on page 81).	-															
40.20	<i>Internal setpoint selection 2</i>	Selects, together with <i>40.19 Internal setpoint selection 1</i> , the internal setpoint out of the presets defined by parameters <i>40.21...40.24</i> . See table at <i>40.19 Internal setpoint selection 1</i> .	<i>Not selected</i>															
	Not selected	0.	0															
	Selected	1.	1															
	DI1	Digital input DI1 ( <i>10.02 DI delayed status</i> , bit 0).	2															

No.	Name/Value	Description	Def/FbEq16
	DI2	Digital input DI2 ( <a href="#">10.02 DI delayed status</a> , bit 1).	3
	DI3	Digital input DI3 ( <a href="#">10.02 DI delayed status</a> , bit 2).	4
	DI4	Digital input DI4 ( <a href="#">10.02 DI delayed status</a> , bit 3).	5
	DI5	Digital input DI5 ( <a href="#">10.02 DI delayed status</a> , bit 4).	6
	DI6	Digital input DI6 ( <a href="#">10.02 DI delayed status</a> , bit 5).	7
	DIO1	Digital input/output DIO1 ( <a href="#">11.02 DIO delayed status</a> , bit 0).	10
	DIO2	Digital input/output DIO2 ( <a href="#">11.02 DIO delayed status</a> , bit 1).	11
	<i>Other [bit]</i>	Source selection (see <a href="#">Terms and abbreviations</a> on page 81).	-
<a href="#">40.21</a>	<a href="#">Internal setpoint 1</a>	Process setpoint preset 1. See parameter <a href="#">40.19 Internal setpoint selection 1</a> . The unit is selected by parameter <a href="#">40.12 Unit selection</a> .	0
	-32768.0 ... 32767.0	Process setpoint preset 1.	1 = 1 unit
<a href="#">40.22</a>	<a href="#">Internal setpoint 2</a>	Process setpoint preset 2. See parameter <a href="#">40.19 Internal setpoint selection 1</a> . The unit is selected by parameter <a href="#">40.12 Unit selection</a> .	0
	-32768.0 ... 32767.0	Process setpoint preset 2.	1 = 1 unit
<a href="#">40.23</a>	<a href="#">Internal setpoint 3</a>	Process setpoint preset 3. See parameter <a href="#">40.19 Internal setpoint selection 1</a> . The unit is selected by parameter <a href="#">40.12 Unit selection</a> .	0
	-32768.0 ... 32767.0	Process setpoint preset 3.	1 = 1 unit
<a href="#">40.24</a>	<a href="#">Internal setpoint 4</a>	Process setpoint preset 4. See parameter <a href="#">40.19 Internal setpoint selection 1</a> . The unit is selected by parameter <a href="#">40.12 Unit selection</a> .	0
	-32768.0 ... 32767.0	Process setpoint preset 4.	1 = 1 unit
<a href="#">40.25</a>	<a href="#">Setpoint selection</a>	Configures the selection between setpoint sources 1 ( <a href="#">40.16</a> ) and 2 ( <a href="#">40.17</a> ). This parameter is only effective when parameter <a href="#">40.18 Setpoint function</a> is set to <i>In1</i> or <i>In2</i> . 0 = Setpoint source 1 1 = Setpoint source 2	<i>Off</i>
	Off	0.	0
	On	1.	1
	DI1	Digital input DI1 ( <a href="#">10.02 DI delayed status</a> , bit 0).	2
	DI2	Digital input DI2 ( <a href="#">10.02 DI delayed status</a> , bit 1).	3
	DI3	Digital input DI3 ( <a href="#">10.02 DI delayed status</a> , bit 2).	4
	DI4	Digital input DI4 ( <a href="#">10.02 DI delayed status</a> , bit 3).	5
	DI5	Digital input DI5 ( <a href="#">10.02 DI delayed status</a> , bit 4).	6
	DI6	Digital input DI6 ( <a href="#">10.02 DI delayed status</a> , bit 5).	7
	DIO1	Digital input/output DIO1 ( <a href="#">11.02 DIO delayed status</a> , bit 0).	10
	DIO2	Digital input/output DIO2 ( <a href="#">11.02 DIO delayed status</a> , bit 1).	11
	<i>Other [bit]</i>	Source selection (see <a href="#">Terms and abbreviations</a> on page 81).	-

No.	Name/Value	Description	Def/FbEq16
40.26	<i>Setpoint min</i>	Defines a minimum limit for the process PID controller setpoint.	0.0
	-32768.0 ... 32767.0	Minimum limit for process PID controller setpoint.	1 = 1
40.27	<i>Setpoint max</i>	Defines a maximum limit for the process PID controller setpoint.	32767.0
	-32768.0 ... 32767.0	Maximum limit for process PID controller setpoint.	1 = 1
40.28	<i>Setpoint increase time</i>	Defines the minimum time it takes for the setpoint to increase from 0% to 100%.	0.0 s
	0.0 ... 1800.0 s	Setpoint increase time.	1 = 1
40.29	<i>Setpoint decrease time</i>	Defines the minimum time it takes for the setpoint to decrease from 100% to 0%.	0.0 s
	0.0 ... 1800.0 s	Setpoint decrease time.	1 = 1
40.30	<i>Setpoint freeze enable</i>	Freezes, or defines a source that can be used to freeze, the setpoint of the process PID controller. This feature is useful when the reference is based on a process feedback connected to an analog input, and the sensor must be serviced without stopping the process. 1 = Process PID controller setpoint frozen See also parameter <i>40.38 Output freeze enable</i> .	<i>Not selected</i>
	Not selected	Process PID controller setpoint not frozen.	0
	Selected	Process PID controller setpoint frozen.	1
	DI1	Digital input DI1 ( <i>10.02 DI delayed status</i> , bit 0).	2
	DI2	Digital input DI2 ( <i>10.02 DI delayed status</i> , bit 1).	3
	DI3	Digital input DI3 ( <i>10.02 DI delayed status</i> , bit 2).	4
	DI4	Digital input DI4 ( <i>10.02 DI delayed status</i> , bit 3).	5
	DI5	Digital input DI5 ( <i>10.02 DI delayed status</i> , bit 4).	6
	DI6	Digital input DI6 ( <i>10.02 DI delayed status</i> , bit 5).	7
	DIO1	Digital input/output DIO1 ( <i>11.02 DIO delayed status</i> , bit 0).	10
	DIO2	Digital input/output DIO2 ( <i>11.02 DIO delayed status</i> , bit 1).	11
	<i>Other [bit]</i>	Source selection (see <i>Terms and abbreviations</i> on page 81).	-
40.31	<i>Deviation inversion</i>	Inverts the input of the process PID controller. 0 = Setpoint - Feedback 1 = Feedback - Setpoint See also section <i>Sleep function for process PID control</i> (page 46).	<i>Ref - Fbk</i>
	Ref - Fbk	0.	0
	Fbk - Ref	1.	1
	<i>Other [bit]</i>	Source selection (see <i>Terms and abbreviations</i> on page 81).	-
40.32	<i>Gain</i>	Defines the gain for the process PID controller. See parameter <i>40.33 Integration time</i> .	1.0
	0.1 ... 100.0	Gain for PID controller.	100 = 1

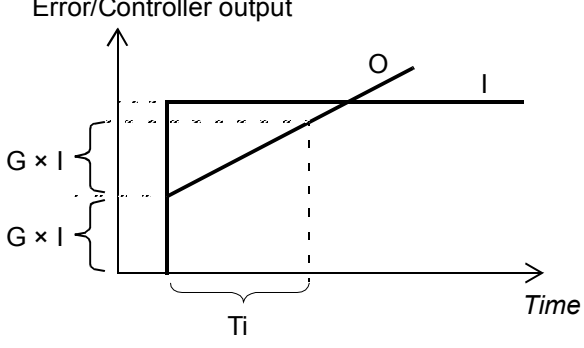
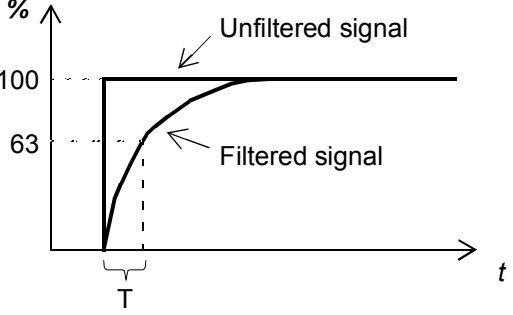

No.	Name/Value	Description	Def/FbEq16
40.33	<i>Integration time</i>	<p>Defines the integration time for the process PID controller.</p>  <p>I = controller input (error) O = controller output G = gain Ti = integration time</p> <p><b>Note:</b> Setting this value to 0 disables the “I” part, turning the PID controller into a PD controller.</p>	60.0 s
	0.0 ... 3600.0 s	Integration time.	1 = 1 s
40.34	<i>Derivation time</i>	<p>Defines the derivation time of the process PID controller. The derivative component at the controller output is calculated on basis of two consecutive error values (<math>E_{K-1}</math> and <math>E_K</math>) according to the following formula:  <math>PID\ DERIV\ TIME \times (E_K - E_{K-1}) / T_S</math>, in which  <math>T_S = 2\ ms</math> sample time  <math>E = Error = Process\ reference - process\ feedback</math>.</p>	0.0 s
	0.0 ... 10.0 s	Derivation time.	1000 = 1 s
40.35	<i>Derivation filter time</i>	<p>Defines the time constant of the 1-pole filter used to smooth the derivative component of the process PID controller.</p>  $O = I \times (1 - e^{-t/T})$ <p>I = filter input (step) O = filter output t = time T = filter time constant</p>	0.0 s
	0.0 ... 10.0 s	Filter time constant.	10 = 1 s

No.	Name/Value	Description	Def/FbEq16
40.36	<i>Output min</i>	Defines the minimum limit for the process PID controller output. Using the minimum and maximum limits, it is possible to restrict the operation range.	-32768.0
	-32768.0 ... 32767.0	Minimum limit for process PID controller output.	1 = 1
40.37	<i>Output max</i>	Defines the maximum limit for the process PID controller output. See parameter <a href="#">40.36 Output min</a> .	32767.0
	-32768.0 ... 32767.0	Maximum limit for process PID controller output.	1 = 1
40.38	<i>Output freeze enable</i>	Freezes, or defines a source that can be used to freeze, the output of the process PID controller. This feature can be used when, for example, a sensor providing process feedback must to be serviced without stopping the process. 1 = Process PID controller output frozen See also parameter <a href="#">40.30 Setpoint freeze enable</a> .	<i>Not selected</i>
	Not selected	Process PID controller output not frozen.	0
	Selected	Process PID controller output frozen.	1
	DI1	Digital input DI1 ( <a href="#">10.02 DI delayed status</a> , bit 0).	2
	DI2	Digital input DI2 ( <a href="#">10.02 DI delayed status</a> , bit 1).	3
	DI3	Digital input DI3 ( <a href="#">10.02 DI delayed status</a> , bit 2).	4
	DI4	Digital input DI4 ( <a href="#">10.02 DI delayed status</a> , bit 3).	5
	DI5	Digital input DI5 ( <a href="#">10.02 DI delayed status</a> , bit 4).	6
	DI6	Digital input DI6 ( <a href="#">10.02 DI delayed status</a> , bit 5).	7
	DIO1	Digital input/output DIO1 ( <a href="#">11.02 DIO delayed status</a> , bit 0).	10
	DIO2	Digital input/output DIO2 ( <a href="#">11.02 DIO delayed status</a> , bit 1).	11
	<i>Other [bit]</i>	Source selection (see <a href="#">Terms and abbreviations</a> on page 81).	-
40.39	<i>Deadband range</i>	Defines a deadband around the setpoint. Whenever process feedback enters the deadband, a delay timer starts. If the feedback remains within the deadband longer than the delay ( <a href="#">40.40 Deadband delay</a> ), the PID controller output is frozen. Normal operation resumes after the feedback value leaves the deadband.	0.0

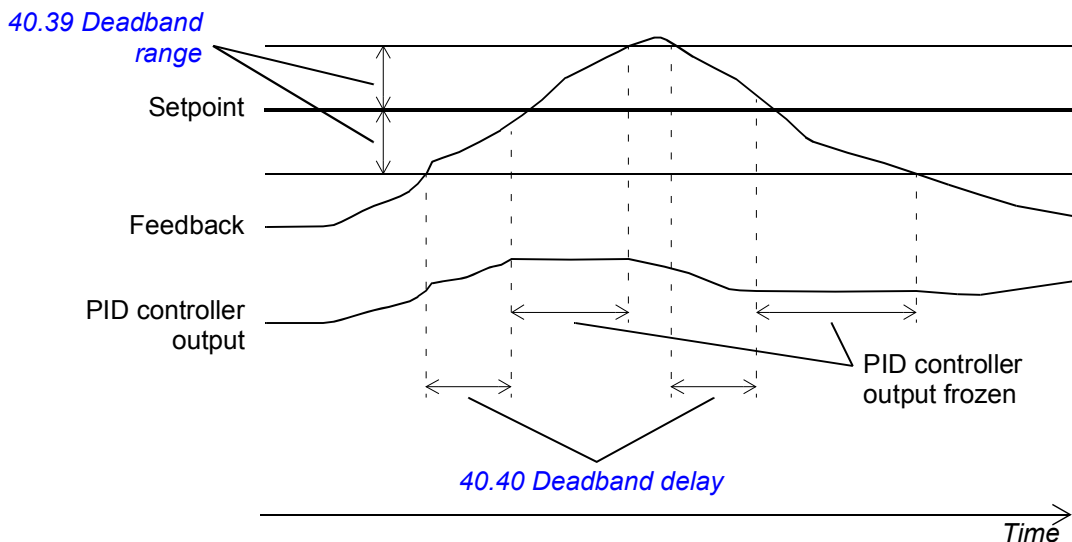

No.	Name/Value	Description	Def/FbEq16
	-32768.0 ... 32767.0	Deadband range.	1 = 1
40.40	<i>Deadband delay</i>	Delay for the deadband. See parameter <i>40.39 Deadband range</i> .	0.0 s
	0.0 ... 3600.0 s	Delay for deadband area.	1 = 1 s
40.41	<i>Sleep mode</i>	Selects the mode of the sleep function. See also section <i>Sleep function for process PID control</i> (page 46).	No
	No	Sleep function disabled.	0
	Internal	The motor speed is compared to the value of <i>40.43 Sleep level</i> . If the motor speed remains below this value longer than the sleep delay ( <i>40.44 Sleep delay</i> ), the drive enters sleep mode. Parameters <i>40.44...40.48</i> are in force.	1
	External	The sleep function is activated by the source selected by parameter <i>40.42 Sleep enable</i> . Parameters <i>40.44...40.48</i> are in force.	2
40.42	<i>Sleep enable</i>	Defines a source that is used to activate the sleep function when parameter <i>40.41 Sleep mode</i> is set to <i>External</i> . 0 = Sleep function disabled 1 = Sleep function activated	Off
	Off	0.	0
	On	1.	1
	DI1	Digital input DI1 ( <i>10.02 DI delayed status</i> , bit 0).	2
	DI2	Digital input DI2 ( <i>10.02 DI delayed status</i> , bit 1).	3
	DI3	Digital input DI3 ( <i>10.02 DI delayed status</i> , bit 2).	4
	DI4	Digital input DI4 ( <i>10.02 DI delayed status</i> , bit 3).	5
	DI5	Digital input DI5 ( <i>10.02 DI delayed status</i> , bit 4).	6
	DI6	Digital input DI6 ( <i>10.02 DI delayed status</i> , bit 5).	7
	DIO1	Digital input/output DIO1 ( <i>11.02 DIO delayed status</i> , bit 0).	10
	DIO2	Digital input/output DIO2 ( <i>11.02 DIO delayed status</i> , bit 1).	11
	<i>Other [bit]</i>	Source selection (see <i>Terms and abbreviations</i> on page 81).	-
40.43	<i>Sleep level</i>	Defines the start limit for the sleep function when parameter <i>40.41 Sleep mode</i> is set to <i>Internal</i> .	0.0
	0.0 ... 32767.0	Sleep start level.	1 = 1
40.44	<i>Sleep delay</i>	Defines a delay for the sleep function. The delay timer starts when the sleep condition selected by parameter <i>40.41 Sleep mode</i> becomes true, and resets if the condition becomes false.	60.0 s
	0.0 ... 3600.0 s	Sleep start delay.	1 = 1 s
40.45	<i>Sleep boost time</i>	Defines a boost time for the sleep boost step. See parameter <i>40.46 Sleep boost step</i> .	0.0 s
	0.0 ... 3600.0 s	Sleep boost time.	1 = 1 s
40.46	<i>Sleep boost step</i>	When the drive is entering sleep mode, the process setpoint is increased by this percentage for the time defined by parameter <i>40.45 Sleep boost time</i> . If active, sleep boost is aborted when the drive wakes up.	0.0
	0.0 ... 32767.0	Sleep boost step.	1 = 1

No.	Name/Value	Description	Def/FbEq16
40.47	<i>Wake-up deviation</i>	Defines the wake-up level as deviation between process setpoint and feedback. The unit is selected by parameter <a href="#">40.12 Unit selection</a> . When the deviation exceeds the value of this parameter, and remains there for the duration of the wake-up delay ( <a href="#">40.48 Wake up delay</a> ), the drive wakes up. See also parameter <a href="#">40.31 Deviation inversion</a> .	0
	-2147483648 ... 2147483647	Wake-up level (as deviation between process setpoint and feedback).	1 = 1 unit
40.48	<i>Wake up delay</i>	Defines a wake-up delay for the sleep function. See parameter <a href="#">40.47 Wake-up deviation</a> . The delay timer starts when the deviation exceeds the wake-up level ( <a href="#">40.47 Wake-up deviation</a> ), and resets if the deviation falls below the wake-up level.	0.50 s
	0.00 ... 60.00 s	Wake-up delay.	1 = 1 s
40.49	<i>Tracking mode</i>	Activates (or selects a source that activates) tracking mode. In tracking mode, the value selected by parameter <a href="#">40.50 Tracking ref selection</a> is substituted for the PID controller output. See also section <a href="#">Tracking</a> (page 47). 1 = Tracking mode enabled	<i>Off</i>
	Off	0.	0
	On	1.	1
	DI1	Digital input DI1 ( <a href="#">10.02 DI delayed status</a> , bit 0).	2
	DI2	Digital input DI2 ( <a href="#">10.02 DI delayed status</a> , bit 1).	3
	DI3	Digital input DI3 ( <a href="#">10.02 DI delayed status</a> , bit 2).	4
	DI4	Digital input DI4 ( <a href="#">10.02 DI delayed status</a> , bit 3).	5
	DI5	Digital input DI5 ( <a href="#">10.02 DI delayed status</a> , bit 4).	6
	DI6	Digital input DI6 ( <a href="#">10.02 DI delayed status</a> , bit 5).	7
	DIO1	Digital input/output DIO1 ( <a href="#">11.02 DIO delayed status</a> , bit 0).	10
	DIO2	Digital input/output DIO2 ( <a href="#">11.02 DIO delayed status</a> , bit 1).	11
	<i>Other [bit]</i>	Source selection (see <a href="#">Terms and abbreviations</a> on page 81).	-
40.50	<i>Tracking ref selection</i>	Selects the value source for tracking mode. See parameter <a href="#">40.49 Tracking mode</a> .	<i>Zero</i>
	Zero	None.	0
	AI1 scaled	<a href="#">12.12 AI1 scaled value</a> (see page 102).	1
	AI2 scaled	<a href="#">12.22 AI2 scaled value</a> (see page 103).	2
	FB A ref1	Fieldbus adapter A reference 1.	3
	FB A ref2	Fieldbus adapter A reference 2.	4
	Other	The value is taken from another parameter.	-
40.51	<i>Trim mode</i>	Activates the trim function and selects between direct and proportional trimming (or a combination of both). With trimming, it is possible to apply a corrective factor to the drive reference (setpoint). The output after trimming is available as parameter <a href="#">40.05 Trim output actual value</a> . See the control chain diagram on page 361.	<i>Off</i>
	Off	The trim function is inactive.	0

No.	Name/Value	Description	Def/FbEq16
	Direct	The trim function is active. The trimming factor is relative to the maximum speed, torque or frequency; the selection between these is made by parameter <a href="#">40.52 Trim selection</a> .	1
	Proportional	The trim function is active. The trimming factor is relative to the reference selected by parameter <a href="#">40.53 Trimmed ref pointer</a> .	2
	Combined	The trim function is active. The trimming factor is a combination of both <a href="#">Direct</a> and <a href="#">Proportional</a> modes; the proportions of each are defined by parameter <a href="#">40.54 Trim mix</a> .	3
<a href="#">40.52</a>	<a href="#">Trim selection</a>	Selects whether trimming is used for correcting the speed, torque or frequency reference.	<a href="#">Torque</a>
	Torque	Torque reference trimming.	1
	Speed	Speed reference trimming.	2
	Frequency	Frequency reference trimming.	3
<a href="#">40.53</a>	<a href="#">Trimmed ref pointer</a>	Selects the signal source for the trim reference.	<a href="#">Zero</a>
	Zero	None.	0
	AI1 scaled	<a href="#">12.12 AI1 scaled value</a> (see page <a href="#">102</a> ).	1
	AI2 scaled	<a href="#">12.22 AI2 scaled value</a> (see page <a href="#">103</a> ).	2
	FB A ref1	Fieldbus adapter A reference 1.	3
	FB A ref2	Fieldbus adapter A reference 2.	4
	Other	The value is taken from another parameter.	-
<a href="#">40.54</a>	<a href="#">Trim mix</a>	When parameter <a href="#">40.51 Trim mode</a> is set to <a href="#">Combined</a> , defines the effect of direct and proportional trim sources in the final trimming factor. 0.000 = 100% proportional 0.500 = 50% proportional, 50% direct 1.000 = 100% direct	0.000
	0.000 ... 1.000	Trim mix.	1 = 1
<a href="#">40.55</a>	<a href="#">Trim adjust</a>	Defines a multiplier for the trimming factor. This value is multiplied by the result of parameter <a href="#">40.51 Trim mode</a> . Consequently, the result of the multiplication is used to multiply the result of parameter <a href="#">40.56 Correction source</a> .	1.000
	-100.000 ... 100.000	Multiplier for trimming factor.	1 = 1
<a href="#">40.56</a>	<a href="#">Correction source</a>	Selects the reference to be trimmed.	<a href="#">PID ref</a>
	PID ref	PID setpoint.	1
	PID output	PID controller output.	2
<a href="#">40.57</a>	<a href="#">Sel between set1 set2</a>	Selects the source that determines whether process PID parameter set 1 (parameters <a href="#">40.07...40.56</a> ) or set 2 (group <a href="#">41 Process PID set 2</a> ) is used. 0 = Process PID parameter set 1 in use 1 = Process PID parameter set 2 in use	<a href="#">Not selected</a>
	Not selected	0.	0
	Selected	1.	1
	DI1	Digital input DI1 ( <a href="#">10.02 DI delayed status</a> , bit 0).	2
	DI2	Digital input DI2 ( <a href="#">10.02 DI delayed status</a> , bit 1).	3
	DI3	Digital input DI3 ( <a href="#">10.02 DI delayed status</a> , bit 2).	4
	DI4	Digital input DI4 ( <a href="#">10.02 DI delayed status</a> , bit 3).	5

## 214 Parameters

No.	Name/Value	Description	Def/FbEq16
	DI5	Digital input DI5 ( <i>10.02 DI delayed status</i> , bit 4).	6
	DI6	Digital input DI6 ( <i>10.02 DI delayed status</i> , bit 5).	7
	DIO1	Digital input/output DIO1 ( <i>11.02 DIO delayed status</i> , bit 0).	10
	DIO2	Digital input/output DIO2 ( <i>11.02 DIO delayed status</i> , bit 1).	11
	<i>Other [bit]</i>	Source selection (see <i>Terms and abbreviations</i> on page 81).	-
<b>41 Process PID set 2</b>		A second set of parameter values for process PID control. The selection between this set and first set (parameter group <i>40 Process PID set 1</i> ) is made by parameter <i>40.57 Sel between set1 set2</i> . See also parameters <i>40.01...40.06</i> , and the control chain diagrams on pages 360 and 361.	
<i>41.07</i>	<i>PID operation mode</i>	See parameter <i>40.07 PID operation mode</i> .	<i>Off</i>
<i>41.08</i>	<i>Feedback 1 source</i>	See parameter <i>40.08 Feedback 1 source</i> .	<i>AI1 scaled</i>
<i>41.09</i>	<i>Feedback 2 source</i>	See parameter <i>40.09 Feedback 2 source</i> .	<i>Zero</i>
<i>41.10</i>	<i>Feedback function</i>	See parameter <i>40.10 Feedback function</i> .	<i>In1</i>
<i>41.11</i>	<i>Feedback filter time</i>	See parameter <i>40.11 Feedback filter time</i> .	0.000 s
<i>41.12</i>	<i>Unit selection</i>	See parameter <i>40.12 Unit selection</i> .	<i>rpm</i>
<i>41.14</i>	<i>Setpoint base</i>	See parameter <i>40.14 Setpoint base</i> .	1500
<i>41.15</i>	<i>Output base</i>	See parameter <i>40.15 Output base</i> .	1500
<i>41.16</i>	<i>Setpoint 1 source</i>	See parameter <i>40.16 Setpoint 1 source</i> .	<i>AI2 scaled</i>
<i>41.17</i>	<i>Setpoint 2 source</i>	See parameter <i>40.17 Setpoint 2 source</i> .	<i>Zero</i>
<i>41.18</i>	<i>Setpoint function</i>	See parameter <i>40.18 Setpoint function</i> .	<i>In1 or In2</i>
<i>41.19</i>	<i>Internal setpoint selection 1</i>	See parameter <i>40.19 Internal setpoint selection 1</i> .	<i>Not selected</i>
<i>41.20</i>	<i>Internal setpoint selection 2</i>	See parameter <i>40.20 Internal setpoint selection 2</i> .	<i>Not selected</i>
<i>41.21</i>	<i>Internal setpoint 1</i>	See parameter <i>40.21 Internal setpoint 1</i> .	0
<i>41.22</i>	<i>Internal setpoint 2</i>	See parameter <i>40.22 Internal setpoint 2</i> .	0
<i>41.23</i>	<i>Internal setpoint 3</i>	See parameter <i>40.23 Internal setpoint 3</i> .	0
<i>41.24</i>	<i>Internal setpoint 4</i>	See parameter <i>40.24 Internal setpoint 4</i> .	0
<i>41.25</i>	<i>Setpoint selection</i>	See parameter <i>40.25 Setpoint selection</i> .	<i>Off</i>
<i>41.26</i>	<i>Setpoint min</i>	See parameter <i>40.26 Setpoint min</i> .	0.0
<i>41.27</i>	<i>Setpoint max</i>	See parameter <i>40.27 Setpoint max</i> .	32767.0
<i>41.28</i>	<i>Setpoint increase time</i>	See parameter <i>40.28 Setpoint increase time</i> .	0.0 s
<i>41.29</i>	<i>Setpoint decrease time</i>	See parameter <i>40.29 Setpoint decrease time</i> .	0.0 s
<i>41.30</i>	<i>Setpoint freeze enable</i>	See parameter <i>40.30 Setpoint freeze enable</i> .	<i>Not selected</i>
<i>41.31</i>	<i>Deviation inversion</i>	See parameter <i>40.31 Deviation inversion</i> .	<i>Ref - Fbk</i>
<i>41.32</i>	<i>Gain</i>	See parameter <i>40.32 Gain</i> .	1.0
<i>41.33</i>	<i>Integration time</i>	See parameter <i>40.33 Integration time</i> .	60.0 s

No.	Name/Value	Description	Def/FbEq16
41.34	<a href="#">Derivation time</a>	See parameter <a href="#">40.34 Derivation time</a> .	0.0 s
41.35	<a href="#">Derivation filter time</a>	See parameter <a href="#">40.35 Derivation filter time</a> .	0.0 s
41.36	<a href="#">Output min</a>	See parameter <a href="#">40.36 Output min</a> .	-32768.0
41.37	<a href="#">Output max</a>	See parameter <a href="#">40.37 Output max</a> .	32767.0
41.38	<a href="#">Output freeze enable</a>	See parameter <a href="#">40.38 Output freeze enable</a> .	<i>Not selected</i>
41.39	<a href="#">Deadband range</a>	See parameter <a href="#">40.39 Deadband range</a> .	0.0
41.40	<a href="#">Deadband delay</a>	See parameter <a href="#">40.40 Deadband delay</a> .	0.0 s
41.41	<a href="#">Sleep mode</a>	See parameter <a href="#">40.41 Sleep mode</a> .	<i>No</i>
41.42	<a href="#">Sleep enable</a>	See parameter <a href="#">40.42 Sleep enable</a> .	<i>Off</i>
41.43	<a href="#">Sleep level</a>	See parameter <a href="#">40.43 Sleep level</a> .	0.0
41.44	<a href="#">Sleep delay</a>	See parameter <a href="#">40.44 Sleep delay</a> .	60.0 s
41.45	<a href="#">Sleep boost time</a>	See parameter <a href="#">40.45 Sleep boost time</a> .	0.0 s
41.46	<a href="#">Sleep boost step</a>	See parameter <a href="#">40.46 Sleep boost step</a> .	0.0
41.47	<a href="#">Wake-up deviation</a>	See parameter <a href="#">40.47 Wake-up deviation</a> .	0
41.48	<a href="#">Wake up delay</a>	See parameter <a href="#">40.48 Wake up delay</a> .	0.50 s
41.49	<a href="#">Tracking mode</a>	See parameter <a href="#">40.49 Tracking mode</a> .	<i>Off</i>
41.50	<a href="#">Tracking ref selection</a>	See parameter <a href="#">40.50 Tracking ref selection</a> .	<i>Zero</i>
41.51	<a href="#">Trim mode</a>	See parameter <a href="#">40.51 Trim mode</a> .	<i>Off</i>
41.52	<a href="#">Trim selection</a>	See parameter <a href="#">40.52 Trim selection</a> .	<i>Torque</i>
41.53	<a href="#">Trimmed ref pointer</a>	See parameter <a href="#">40.53 Trimmed ref pointer</a> .	<i>Zero</i>
41.54	<a href="#">Trim mix</a>	See parameter <a href="#">40.54 Trim mix</a> .	0.000
41.55	<a href="#">Trim adjust</a>	See parameter <a href="#">40.55 Trim adjust</a> .	1.000
41.56	<a href="#">Correction source</a>	See parameter <a href="#">40.56 Correction source</a> .	<i>PID ref</i>
<b>43 Brake chopper</b>		Settings of the internal brake chopper.	
43.01	<a href="#">Braking resistor temperature</a>	Displays the estimated temperature of the braking resistor. The value is given in percent of the temperature the resistor reaches when loaded with the power defined by parameter <a href="#">43.09 Brake resistor Pmax cont</a> . This parameter is read-only.	-
	0.0 ... 120.0%	Estimated brake resistor temperature.	1 = 1%
43.06	<a href="#">Brake chopper enable</a>	Enables brake chopper control. <b>Note:</b> Before enabling brake chopper control, ensure that <ul style="list-style-type: none"> <li>a brake resistor is connected</li> <li>overvoltage control is switched off (parameter <a href="#">30.30 Overvoltage control</a>)</li> <li>the supply voltage range (parameter <a href="#">95.01 Supply voltage</a>) has been selected correctly.</li> </ul>	<i>Disabled</i>
	Disabled	Brake chopper control disabled.	0
	Enabled with thermal model	Brake chopper control enabled with resistor overload protection.	1

No.	Name/Value	Description	Def/FbEq16
	Enabled without thermal model	Brake chopper control enabled without resistor overload protection. This setting can be used, for example, if the resistor is equipped with a thermal circuit breaker that is wired to stop the drive if the resistor overheats.	2
43.07	<i>Brake chopper runtime enable</i>	Selects the source for quick run-time brake chopper control. 0 = Brake chopper IGBT pulses are cut off 1 = Normal brake chopper IGBT modulation. This parameter can be used to program the chopper control to function only when the drive is operating in generating mode.	On
	Off	0.	0
	On	1.	1
	<i>Other [bit]</i>	Source selection (see <i>Terms and abbreviations</i> on page 81).	-
43.08	<i>Brake resistor thermal tc</i>	Defines the thermal time constant of the brake resistor for overload protection.	0 s
	0 ... 10000 s	Brake resistor thermal time constant.	1 = 1 s
43.09	<i>Brake resistor Pmax cont</i>	Defines the maximum continuous braking power which will raise the resistor temperature to the maximum allowed value. The value is used in the overload protection.	-
	0.10 ... 10000.00 kW	Maximum continuous braking power.	1 = 1 kW
43.10	<i>Brake resistance</i>	Defines the resistance value of the brake resistor. The value is used for brake chopper protection.	0 ohm
	0...1000 ohm	Brake resistor resistance value.	1 = 1 ohm
43.11	<i>Brake resistor fault limit</i>	Selects the fault limit for the brake resistor temperature supervision. When the limit is exceeded, the drive trips on fault <i>7183 BR excess temperature</i> . The value is given in percent of the temperature the resistor reaches when loaded with the power defined by parameter <i>43.09 Brake resistor Pmax cont</i> .	105%
	0 ... 150%	Brake resistor temperature fault limit.	1 = 1%
43.12	<i>Brake resistor warning limit</i>	Selects the warning limit for the brake resistor temperature supervision. When the limit is exceeded, the drive generates a <i>A793 BR excess temperature</i> warning. The value is given in percent of the temperature the resistor reaches when loaded with the power defined by parameter <i>43.09 Brake resistor Pmax cont</i> .	95%
	0 ... 150%	Brake resistor temperature warning limit.	1 = 1%



No.	Name/Value	Description	Def/FbEq16																																	
<b>44 Mechanical brake control</b>		Configuration of mechanical brake control. See also section <a href="#">Mechanical brake control</a> (page 48).																																		
44.01	<a href="#">Brake control status</a>	Displays the mechanical brake control status word. This parameter is read-only.	-																																	
		<table border="1"> <thead> <tr> <th>Bit</th> <th>Name</th> <th>Information</th> </tr> </thead> <tbody> <tr> <td>0</td> <td>Open command</td> <td>Close/open command to brake actuator (0 = close, 1 = open). Connect this bit to desired output.</td> </tr> <tr> <td>1</td> <td>Opening torque</td> <td>1 = Opening torque requested from drive logic</td> </tr> <tr> <td>2</td> <td>Hold stopped request</td> <td>1 = Hold requested from drive logic</td> </tr> <tr> <td>3</td> <td>Ramp to stopped</td> <td>1 = Ramping down to zero speed requested from drive logic</td> </tr> <tr> <td>4</td> <td>Enabled</td> <td>1 = Brake control is enabled</td> </tr> <tr> <td>5</td> <td>Closed</td> <td>1 = Brake control logic in <a href="#">BRAKE CLOSED</a> state</td> </tr> <tr> <td>6</td> <td>Opening</td> <td>1 = Brake control logic in <a href="#">BRAKE OPENING</a> state</td> </tr> <tr> <td>7</td> <td>Open</td> <td>1 = Brake control logic in <a href="#">BRAKE OPEN</a> state</td> </tr> <tr> <td>8</td> <td>Closing</td> <td>1 = Brake control logic in <a href="#">BRAKE CLOSING</a> state</td> </tr> <tr> <td>9...15</td> <td>Reserved</td> <td></td> </tr> </tbody> </table>	Bit	Name	Information	0	Open command	Close/open command to brake actuator (0 = close, 1 = open). Connect this bit to desired output.	1	Opening torque	1 = Opening torque requested from drive logic	2	Hold stopped request	1 = Hold requested from drive logic	3	Ramp to stopped	1 = Ramping down to zero speed requested from drive logic	4	Enabled	1 = Brake control is enabled	5	Closed	1 = Brake control logic in <a href="#">BRAKE CLOSED</a> state	6	Opening	1 = Brake control logic in <a href="#">BRAKE OPENING</a> state	7	Open	1 = Brake control logic in <a href="#">BRAKE OPEN</a> state	8	Closing	1 = Brake control logic in <a href="#">BRAKE CLOSING</a> state	9...15	Reserved		
Bit	Name	Information																																		
0	Open command	Close/open command to brake actuator (0 = close, 1 = open). Connect this bit to desired output.																																		
1	Opening torque	1 = Opening torque requested from drive logic																																		
2	Hold stopped request	1 = Hold requested from drive logic																																		
3	Ramp to stopped	1 = Ramping down to zero speed requested from drive logic																																		
4	Enabled	1 = Brake control is enabled																																		
5	Closed	1 = Brake control logic in <a href="#">BRAKE CLOSED</a> state																																		
6	Opening	1 = Brake control logic in <a href="#">BRAKE OPENING</a> state																																		
7	Open	1 = Brake control logic in <a href="#">BRAKE OPEN</a> state																																		
8	Closing	1 = Brake control logic in <a href="#">BRAKE CLOSING</a> state																																		
9...15	Reserved																																			
	0000h...FFFFh	Mechanical brake control status word.	1 = 1																																	
44.02	<a href="#">Brake torque memory</a>	Torque (in percent). Memorized when a brake close command is issued. This value can be used as a reference for the brake open torque. See parameters <a href="#">44.09 Brake open torque source</a> and <a href="#">44.10 Brake open torque</a> .	-																																	
	-1600.0 ... 1600.0 %	Torque at brake closure.	See par. <a href="#">46.03</a>																																	
44.03	<a href="#">Brake open torque reference</a>	Displays the currently active brake open torque. See parameters <a href="#">44.09 Brake open torque source</a> and <a href="#">44.10 Brake open torque</a> . This parameter is read-only.	-																																	
	-1000 ... 1000%	Currently active brake open torque.	See par. <a href="#">46.03</a>																																	
44.06	<a href="#">Brake control enable</a>	Activates/deactivates (or selects a source that activates/deactivates) the mechanical brake control logic. 0 = Brake control inactive 1 = Brake control active	<a href="#">Off</a>																																	
	Off	0.	0																																	
	On	1.	1																																	
	DI1	Digital input DI1 ( <a href="#">10.02 DI delayed status</a> , bit 0).	2																																	
	DI2	Digital input DI2 ( <a href="#">10.02 DI delayed status</a> , bit 1).	3																																	
	DI3	Digital input DI3 ( <a href="#">10.02 DI delayed status</a> , bit 2).	4																																	
	DI4	Digital input DI4 ( <a href="#">10.02 DI delayed status</a> , bit 3).	5																																	
	DI5	Digital input DI5 ( <a href="#">10.02 DI delayed status</a> , bit 4).	6																																	
	DI6	Digital input DI6 ( <a href="#">10.02 DI delayed status</a> , bit 5).	7																																	
	DIO1	Digital input/output DIO1 ( <a href="#">11.02 DIO delayed status</a> , bit 0).	10																																	
	DIO2	Digital input/output DIO2 ( <a href="#">11.02 DIO delayed status</a> , bit 1).	11																																	

No.	Name/Value	Description	Def/FbEq16
	<i>Other [bit]</i>	Source selection (see <i>Terms and abbreviations</i> on page 81).	-
44.07	<i>Brake acknowledge selection</i>	Activates/deactivates (and selects the source for) brake open/close status (acknowledgement) supervision. When a brake control error (unexpected state of the acknowledgement signal) is detected, the drive reacts as defined by parameter <i>44.17 Brake fault function</i> . 0 = Brake open 1 = Brake closed	<i>No acknowledge</i>
	Off	0.	0
	On	1.	1
	No acknowledge	Brake open/closed supervision disabled.	2
	DI1	Digital input DI1 ( <i>10.02 DI delayed status</i> , bit 0).	3
	DI2	Digital input DI2 ( <i>10.02 DI delayed status</i> , bit 1).	4
	DI3	Digital input DI3 ( <i>10.02 DI delayed status</i> , bit 2).	5
	DI4	Digital input DI4 ( <i>10.02 DI delayed status</i> , bit 3).	6
	DI5	Digital input DI5 ( <i>10.02 DI delayed status</i> , bit 4).	7
	DI6	Digital input DI6 ( <i>10.02 DI delayed status</i> , bit 5).	8
	DIO1	Digital input/output DIO1 ( <i>11.02 DIO delayed status</i> , bit 0).	11
	DIO2	Digital input/output DIO2 ( <i>11.02 DIO delayed status</i> , bit 1).	12
	<i>Other [bit]</i>	Source selection (see <i>Terms and abbreviations</i> on page 81).	-
44.08	<i>Brake open delay</i>	Defines the brake open delay, ie. the delay between the internal open brake command and the release of motor speed control. The delay timer starts when the drive has magnetized the motor and increased the motor torque to the level required for brake release (parameter <i>44.03 Brake open torque reference</i> ). Simultaneously with the timer start, the brake control logic energizes the brake control output and the brake starts to open. Set this parameter to the value of mechanical opening delay specified by the brake manufacturer.	0.00 s
	0.00 ... 5.00 s	Brake open delay.	100 = 1 s
44.09	<i>Brake open torque source</i>	Defines a source that is used as a brake opening torque reference if <ul style="list-style-type: none"> <li>its absolute value is greater than the setting of parameter <i>44.10 Brake open torque</i>, and</li> <li>its sign is the same as the setting of <i>44.10 Brake open torque</i>.</li> </ul> See parameter <i>44.10 Brake open torque</i> .	<i>Brake open torque</i>
	Zero	Zero.	0
	AI1 scaled	<i>12.12 AI1 scaled value</i> (see page 102).	1
	AI2 scaled	<i>12.22 AI2 scaled value</i> (see page 103).	2
	FBA ref1	Fieldbus adapter A reference 1.	3
	FBA ref2	Fieldbus adapter A reference 2.	4
	Brake torque memory	Parameter <i>44.02 Brake torque memory</i> .	7
	Brake open torque	Parameter <i>44.10 Brake open torque</i> .	8
	Other	The value is taken from another parameter.	-

No.	Name/Value	Description	Def/FbEq16
44.10	<i>Brake open torque</i>	Defines the sign (ie. direction of rotation) and minimum absolute value of the brake open torque (motor torque requested at brake release in percent of motor nominal torque). The value of the source selected by parameter <i>44.09 Brake open torque source</i> is used as the brake open torque only if it has the same sign as this parameter and has a greater absolute value.	0%
	-1000 ... 1000%	Minimum torque at brake release.	See par. <i>46.03</i>
44.11	<i>Keep brake closed</i>	Selects a source that prevents the brake from opening. 0 = Normal brake operation 1 = Keep brake closed <b>Note:</b> This parameter cannot be changed while the drive is running.	<i>Off</i>
	Off	0.	0
	On	1.	1
	DI1	Digital input DI1 ( <i>10.02 DI delayed status</i> , bit 0).	2
	DI2	Digital input DI2 ( <i>10.02 DI delayed status</i> , bit 1).	3
	DI3	Digital input DI3 ( <i>10.02 DI delayed status</i> , bit 2).	4
	DI4	Digital input DI4 ( <i>10.02 DI delayed status</i> , bit 3).	5
	DI5	Digital input DI5 ( <i>10.02 DI delayed status</i> , bit 4).	6
	DI6	Digital input DI6 ( <i>10.02 DI delayed status</i> , bit 5).	7
	DIO1	Digital input/output DIO1 ( <i>11.02 DIO delayed status</i> , bit 0).	10
	DIO2	Digital input/output DIO2 ( <i>11.02 DIO delayed status</i> , bit 1).	11
	<i>Other [bit]</i>	Source selection (see <i>Terms and abbreviations</i> on page 81).	-
44.12	<i>Brake close request</i>	Selects the source of an external brake close request signal. When on, the signal overrides the internal logic and closes the brake. 0 = Normal operation/No external close signal connected 1 = Close brake <b>Note:</b> This parameter cannot be changed while the drive is running.	<i>Off</i>
	Off	0.	0
	On	1.	1
	DI1	Digital input DI1 ( <i>10.02 DI delayed status</i> , bit 0).	2
	DI2	Digital input DI2 ( <i>10.02 DI delayed status</i> , bit 1).	3
	DI3	Digital input DI3 ( <i>10.02 DI delayed status</i> , bit 2).	4
	DI4	Digital input DI4 ( <i>10.02 DI delayed status</i> , bit 3).	5
	DI5	Digital input DI5 ( <i>10.02 DI delayed status</i> , bit 4).	6
	DI6	Digital input DI6 ( <i>10.02 DI delayed status</i> , bit 5).	7
	DIO1	Digital input/output DIO1 ( <i>11.02 DIO delayed status</i> , bit 0).	10
	DIO2	Digital input/output DIO2 ( <i>11.02 DIO delayed status</i> , bit 1).	11
	<i>Other [bit]</i>	Source selection (see <i>Terms and abbreviations</i> on page 81).	-

## 220 Parameters

No.	Name/Value	Description	Def/FbEq16
44.13	<i>Brake close delay</i>	Specifies a delay between a close command (that is, when the brake control output is de-energized) and when the drive stops modulating. This is to keep the motor live and under control until the brake actually closes. Set this parameter equal to the value specified by the brake manufacturer as the mechanical make-up time of the brake.	0.00 s
	0.00 ... 60.00 s	Brake close delay.	100 = 1 s
44.14	<i>Brake close level</i>	Defines the brake close speed as an absolute value. After motor speed remains below this level for the duration of the brake close level delay ( <i>44.15 Brake close level delay</i> ), a close command is given.	10.0 rpm
	0.0 ... 1000.0 rpm	Brake close speed.	See par. <i>46.01</i>
44.15	<i>Brake close level delay</i>	Brake close level delay. See parameter <i>44.14 Brake close level</i> .	0.00 s
	0.00 ... 10.00 s	Brake close level delay.	100 = 1 s
44.16	<i>Brake reopen delay</i>	Defines a minimum time between brake closure and a subsequent open command.	0.00 s
	0.00 ... 10.00 s	Brake reopen delay.	100 = 1 s
44.17	<i>Brake fault function</i>	Determines how the drive reacts upon a mechanical brake control error. <b>Note:</b> If parameter <i>44.07 Brake acknowledge selection</i> is set to <i>No acknowledge</i> , acknowledgement status supervision is disabled altogether and will generate no warnings or faults. However, the brake open conditions are always supervised.	<i>Fault</i>
	Fault	The drive trips on a <i>71A2 Mechanical brake closing failed</i> / <i>71A3 Mechanical brake opening failed</i> fault if the status of the acknowledgement does not match the status presumed by the brake control logic. The drive trips on a <i>71A5 Mechanical brake opening not allowed</i> fault if the brake open conditions cannot be fulfilled (for example, the required motor starting torque is not achieved).	0
	Warning	The drive generates a <i>A7A1 Mechanical brake closing failed</i> / <i>A7A2 Mechanical brake opening failed</i> warning if the status of the acknowledgement does not match the status presumed by the brake control logic. The drive generates a <i>A7A5 Mechanical brake opening not allowed</i> warning if the brake open conditions cannot be fulfilled (for example, the required motor starting torque is not achieved).	1
	Open fault	Upon closing the brake, the drive generates a <i>A7A1 Mechanical brake closing failed</i> warning if the status of the acknowledgement does not match the status presumed by the brake control logic. Upon opening the brake, the drive trips on a <i>71A3 Mechanical brake opening failed</i> fault if the status of the acknowledgement does not match the status presumed by the brake control logic. The drive trips on a <i>71A5 Mechanical brake opening not allowed</i> fault if the brake open conditions cannot be fulfilled (for example, the required motor starting torque is not achieved).	2

No.	Name/Value	Description	Def/FbEq16
44.18	<i>Brake fault delay</i>	Defines a close fault delay, ie. time between brake closure and brake close fault trip.	0.00 s
	0.00 ... 60.00 s	Brake close fault delay.	100 = 1 s
<b>45 Energy efficiency</b>		Settings of the energy savings calculator. See also section <i>Energy savings calculator</i> (page 61).	
45.01	<i>Saved GW hours</i>	Energy saved in GWh compared to direct-on-line motor connection. This parameter is incremented when <i>45.02 Saved MW hours</i> rolls over. This parameter is read-only (see parameter <i>45.21 Energy calculations reset</i> ).	-
	0...65535 GWh	Energy savings in GWh.	1 = 1 GWh
45.02	<i>Saved MW hours</i>	Energy saved in MWh compared to direct-on-line motor connection. This parameter is incremented when <i>45.03 Saved kW hours</i> rolls over. When this parameter rolls over, parameter <i>45.01 Saved GW hours</i> is incremented. This parameter is read-only (see parameter <i>45.21 Energy calculations reset</i> ).	-
	0...999 MWh	Energy savings in MWh.	1 = 1 MWh
45.03	<i>Saved kW hours</i>	Energy saved in kWh compared to direct-on-line motor connection. If the internal braking chopper of the drive is enabled, all energy fed by the motor to the drive is assumed to be converted into heat. When this parameter rolls over, parameter <i>45.02 Saved MW hours</i> is incremented. This parameter is read-only (see parameter <i>45.21 Energy calculations reset</i> ).	-
	0.0 ... 999.9 kWh	Energy savings in kWh.	10 = 1 kWh
45.05	<i>Saved money x1000</i>	Monetary savings in thousands compared to direct-on-line motor connection. This parameter is incremented when <i>45.06 Saved money</i> rolls over. The currency is defined by parameter <i>45.17 Tariff currency unit</i> . This parameter is read-only (see parameter <i>45.21 Energy calculations reset</i> ).	-
	0...4294967295 thousands	Monetary savings in thousands of units.	1 = 1 thousand
45.06	<i>Saved money</i>	Monetary savings compared to direct-on-line motor connection. This value is calculated by multiplying the saved energy in kWh by the currently active energy tariff ( <i>45.14 Tariff selection</i> ). When this parameter rolls over, parameter <i>45.05 Saved money x1000</i> is incremented. The currency is defined by parameter <i>45.17 Tariff currency unit</i> . This parameter is read-only (see parameter <i>45.21 Energy calculations reset</i> ).	-
	0.00 ... 999.99 units	Monetary savings.	1 = 1 unit

## 222 Parameters

No.	Name/Value	Description	Def/FbEq16
45.08	<i>CO2 reduction in kilotons</i>	Reduction in CO <sub>2</sub> emissions in metric kilotons compared to direct-on-line motor connection. This value is incremented when parameter <a href="#">45.09 CO2 reduction in tons</a> rolls over. This parameter is read-only (see parameter <a href="#">45.21 Energy calculations reset</a> ).	-
	0...65535 metric kilotons	Reduction in CO <sub>2</sub> emissions in metric kilotons.	1 = 1 metric kiloton
45.09	<i>CO2 reduction in tons</i>	Reduction in CO <sub>2</sub> emissions in metric tons compared to direct-on-line motor connection. This value is calculated by multiplying the saved energy in MWh by the value of parameter <a href="#">45.18 CO2 conversion factor</a> (by default, 0.5 metric tons/MWh). When this parameter rolls over, parameter <a href="#">45.08 CO2 reduction in kilotons</a> is incremented. This parameter is read-only (see parameter <a href="#">45.21 Energy calculations reset</a> ).	-
	0.0 ... 999.9 metric tons	Reduction in CO <sub>2</sub> emissions in metric tons.	1 = 1 metric ton
45.11	<i>Energy optimizer</i>	Enables/disables the energy optimization function. The function optimizes the flux so that total energy consumption and motor noise level are reduced when the drive operates below the nominal load. The total efficiency (motor and drive) can be improved by 1...10% depending on load torque and speed. <b>Note:</b> With a permanent magnet motor, energy optimization is always enabled regardless of this parameter.	<i>Disable</i>
	Disable	Energy optimization disabled.	0
	Enable	Energy optimization enabled.	1
45.12	<i>Energy tariff 1</i>	Defines energy tariff 1 (price of energy per kWh). Depending on the setting of parameter <a href="#">45.14 Tariff selection</a> , this value or <a href="#">45.13 Energy tariff 2</a> is used for reference when monetary savings are calculated. The currency is defined by parameter <a href="#">45.17 Tariff currency unit</a> . <b>Note:</b> Tariffs are read only at the instant of selection, and are not applied retroactively.	1.000 units
	0.000 ... 4294967295.000 units	Energy tariff 1.	-
45.13	<i>Energy tariff 2</i>	Defines energy tariff 2 (price of energy per kWh). See parameter <a href="#">45.12 Energy tariff 1</a> .	2.000 units
	0.000 ... 4294967295.000 units	Energy tariff 2.	-
45.14	<i>Tariff selection</i>	Selects (or defines a source that selects) which pre-defined energy tariff is used. 0 = <a href="#">45.12 Energy tariff 1</a> 1 = <a href="#">45.13 Energy tariff 2</a>	<i>Energy tariff 1</i>
	Energy tariff 1	0.	0
	Energy tariff 2	1.	1
	DI1	Digital input DI1 ( <a href="#">10.02 DI delayed status</a> , bit 0).	2
	DI2	Digital input DI2 ( <a href="#">10.02 DI delayed status</a> , bit 1).	3

No.	Name/Value	Description	Def/FbEq16
	DI3	Digital input DI3 ( <a href="#">10.02 DI delayed status</a> , bit 2).	4
	DI4	Digital input DI4 ( <a href="#">10.02 DI delayed status</a> , bit 3).	5
	DI5	Digital input DI5 ( <a href="#">10.02 DI delayed status</a> , bit 4).	6
	DI6	Digital input DI6 ( <a href="#">10.02 DI delayed status</a> , bit 5).	7
	DIO1	Digital input/output DIO1 ( <a href="#">11.02 DIO delayed status</a> , bit 0).	10
	DIO2	Digital input/output DIO2 ( <a href="#">11.02 DIO delayed status</a> , bit 1).	11
	<i>Other [bit]</i>	Source selection (see <a href="#">Terms and abbreviations</a> on page 81).	-
<b>45.17</b>	<b><i>Tariff currency unit</i></b>	Specifies the currency used for the savings calculations.	<b><i>EUR</i></b>
	EUR	Euro.	101
	USD	US dollar.	102
	Local currency	The currency is determined by the language selection (see parameter <a href="#">96.01 Language</a> ).	100
<b>45.18</b>	<b><i>CO2 conversion factor</i></b>	Defines a factor for conversion of saved energy into CO <sub>2</sub> emissions (kg/kWh or tn/MWh).	0.500 tn/MWh
	0.000 ... 65.535 tn/MWh	Factor for conversion of saved energy into CO <sub>2</sub> emissions.	1 = 1 tn/MWh
<b>45.19</b>	<b><i>Comparison power</i></b>	Motor power when connected directly to the supply. The value is used for reference when energy savings are calculated. <b>Note:</b> The accuracy of the energy savings calculation is directly dependent on the accuracy of this value.	-
	0.0 ... 10000000.0 kW	Motor power.	1 = 1 kW
<b>45.21</b>	<b><i>Energy calculations reset</i></b>	Resets the savings counter parameters <a href="#">45.01...45.09</a> .	<b><i>Done</i></b>
	Done	Reset not requested (normal operation).	0
	Reset	Reset the savings counter parameters. The value reverts automatically to <b><i>Done</i></b> .	1
<b><i>46 Monitoring/scaling settings</i></b>		Speed supervision settings; actual signal filtering; general scaling settings.	
<b>46.01</b>	<b><i>Speed scaling</i></b>	Defines the terminal speed value used in acceleration and the initial speed value used in deceleration (see parameter group <a href="#">23 Speed reference ramp</a> ). Also defines the 16-bit scaling of speed-related parameters. The value of this parameter corresponds to 20000 in fieldbus, master/follower etc. communication.	1500 rpm
	0...30000 rpm	Acceleration/deceleration terminal/initial speed.	1 = 1 rpm
<b>46.02</b>	<b><i>Frequency scaling</i></b>	Defines the terminal frequency value used in acceleration and the initial speed value used in deceleration (see parameter group <a href="#">28 Frequency reference chain</a> ). Also defines the 16-bit scaling of frequency-related parameters. The value of this parameter corresponds to 20000 in fieldbus, master/follower etc. communication.	50.00 Hz
	0.10 ... 1000.00 Hz	Acceleration/deceleration terminal/initial frequency.	10 = 1 Hz
<b>46.03</b>	<b><i>Torque scaling</i></b>	Defines the 16-bit scaling of torque signals. The value of this parameter (in percent of nominal motor torque) corresponds to 10000 in fieldbus, master/follower etc. communication.	100.0%
	0.0 ... 30000.0%	Torque corresponding to 10000 on fieldbus.	10 = 1%

## 224 Parameters



No.	Name/Value	Description	Def/FbEq16
46.04	<i>Power scaling</i>	Defines the output power value that corresponds to 10000 in fieldbus, master/follower etc. communication.	1000.0 kW
	0.0 ... 30000.0 kW	Power corresponding to 10000 on fieldbus.	1 = 1 kW
46.11	<i>Filter time motor speed</i>	Defines a filter time for signals <i>01.01 Motor speed used</i> , <i>01.02 Motor speed estimated</i> , <i>01.04 Encoder 1 speed filtered</i> and <i>01.05 Encoder 2 speed filtered</i> .	500 ms
	2...20000 ms	Motor speed signal filter time.	1 = 1 ms
46.12	<i>Filter time output frequency</i>	Defines a filter time for signal <i>01.06 Output frequency</i> .	500 ms
	2...20000 ms	Output frequency signal filter time.	1 = 1 ms
46.13	<i>Filter time motor torque</i>	Defines a filter time for signal <i>01.10 Motor torque %</i> .	100 ms
	2...20000 ms	Motor torque signal filter time.	1 = 1 ms
46.14	<i>Filter time power out</i>	Defines a filter time for signal <i>01.14 Output power..</i>	100 ms
	2...20000 ms	Output power signal filter time.	1 = 1 ms
46.21	<i>Speed setpoint hysteresis</i>	Defines the absolute value for the motor speed window supervision, ie. the absolute value of the difference between actual speed and speed reference ( <i>90.01 Motor speed for control</i> - <i>22.87 Speed reference 7 act</i> ). When motor speed is within the limits defined by this parameter, bit 8 of <i>06.11 Main status word</i> is 1. If motor speed is not within the limits, bit 8 is 0.	100.00 rpm
	0.00 ... 30000.00 rpm	Absolute value for motor speed window supervision.	See par. <a href="#">46.01</a>
46.22	<i>Frequency setpoint hysteresis</i>	Defines the absolute value for the motor frequency window supervision, ie. the absolute value of the difference between actual frequency and frequency reference ( <i>01.06 Output frequency</i> - <i>28.96 Frequency ref ramp in</i> ). When motor frequency is within the limits defined by this parameter, bit 8 of <i>06.11 Main status word</i> is 1. If motor frequency is not within the limits, bit 8 is 0.	10.00 Hz
	0.00 ... 1000.00 Hz	Absolute value for motor frequency window supervision.	See par. <a href="#">46.02</a>
46.23	<i>Torque setpoint hysteresis</i>	Defines the absolute value for the motor torque window supervision, ie. the absolute value of the difference between actual torque and torque reference ( <i>01.10 Motor torque %</i> - <i>26.73 Torque ref4 actual</i> ). When motor torque is within the limits defined by this parameter, bit 8 of <i>06.11 Main status word</i> is 1. If motor torque is not within the limits, bit 8 is 0.	10%
	0...300%	Absolute value for motor torque window supervision.	See par. <a href="#">46.03</a>
46.31	<i>Above speed limit</i>	Defines the supervision limit for actual speed. See also parameter <i>06.11 Main status word</i> , bit 10.	0.00 rpm
	0.00 ... 30000.00 rpm	Actual speed supervision limit.	See par. <a href="#">46.01</a>
46.32	<i>Above frequency limit</i>	Defines the supervision limit for actual frequency. See also parameter <i>06.11 Main status word</i> , bit 10.	0.00 Hz
	0.00 ... 1000.00 Hz	Actual frequency supervision limit.	See par. <a href="#">46.02</a>





No.	Name/Value	Description	Def/FbEq16
46.33	<i>Above torque limit</i>	Defines the supervision limit for actual torque. See also parameter <i>06.11 Main status word</i> , bit 10.	0.0 N•m
	0.0 ... 300.0 N•m	Actual torque supervision limit.	1 = 1 N•m
<b>47 Data storage</b>		Data storage parameters that can be written to and read from using other parameters' source and target settings. Note that there are different storage parameters for different data types. See also section <i>Data storage parameters</i> (page 64).	
47.01	<i>Data storage 1 real32</i>	Data storage parameter 1.	0.000
	-2147483.008 ... 2147483.008	32-bit data.	-
47.02	<i>Data storage 2 real32</i>	Data storage parameter 2.	0.000
	-2147483.008 ... 2147483.008	32-bit data.	-
47.03	<i>Data storage 3 real32</i>	Data storage parameter 3.	0.000
	-2147483.008 ... 2147483.008	32-bit data.	-
47.04	<i>Data storage 4 real32</i>	Data storage parameter 4.	0.000
	-2147483.008 ... 2147483.008	32-bit data.	-
47.05	<i>Data storage 5 real32</i>	Data storage parameter 5.	0.000
	-2147483.008 ... 2147483.008	32-bit data.	-
47.06	<i>Data storage 6 real32</i>	Data storage parameter 6.	0.000
	-2147483.008 ... 2147483.008	32-bit data.	-
47.07	<i>Data storage 7 real32</i>	Data storage parameter 7.	0.000
	-2147483.008 ... 2147483.008	32-bit data.	-
47.08	<i>Data storage 8 real32</i>	Data storage parameter 8.	0.000
	-2147483.008 ... 2147483.008	32-bit data.	-
47.11	<i>Data storage 1 int32</i>	Data storage parameter 9.	0
	-2147483648 ... 2147483647	32-bit data.	-
47.12	<i>Data storage 2 int32</i>	Data storage parameter 10.	0
	-2147483648 ... 2147483647	32-bit data.	-

## 226 Parameters

No.	Name/Value	Description	Def/FbEq16
47.13	<i>Data storage 3</i> <i>int32</i>	Data storage parameter 11.	0
	-2147483648 ... 2147483647	32-bit data.	-
47.14	<i>Data storage 4</i> <i>int32</i>	Data storage parameter 12.	0
	-2147483648 ... 2147483647	32-bit data.	-
47.15	<i>Data storage 5</i> <i>int32</i>	Data storage parameter 13.	0
	-2147483648 ... 2147483647	32-bit data.	-
47.16	<i>Data storage 6</i> <i>int32</i>	Data storage parameter 14.	0
	-2147483648 ... 2147483647	32-bit data.	-
47.17	<i>Data storage 7</i> <i>int32</i>	Data storage parameter 15.	0
	-2147483648 ... 2147483647	32-bit data.	-
47.18	<i>Data storage 8</i> <i>int32</i>	Data storage parameter 16.	0
	-2147483648 ... 2147483647	32-bit data.	-
47.21	<i>Data storage 1</i> <i>int16</i>	Data storage parameter 17.	0
	-32768 ... 32767	16-bit data.	1 = 1
47.22	<i>Data storage 2</i> <i>int16</i>	Data storage parameter 18.	0
	-32768 ... 32767	16-bit data.	1 = 1
47.23	<i>Data storage 3</i> <i>int16</i>	Data storage parameter 19.	0
	-32768 ... 32767	16-bit data.	1 = 1
47.24	<i>Data storage 4</i> <i>int16</i>	Data storage parameter 20.	0
	-32768 ... 32767	16-bit data.	1 = 1
47.25	<i>Data storage 5</i> <i>int16</i>	Data storage parameter 21.	0
	-32768 ... 32767	16-bit data.	1 = 1
47.26	<i>Data storage 6</i> <i>int16</i>	Data storage parameter 22.	0
	-32768 ... 32767	16-bit data.	1 = 1
47.27	<i>Data storage 7</i> <i>int16</i>	Data storage parameter 23.	0
	-32768 ... 32767	16-bit data.	1 = 1
47.28	<i>Data storage 8</i> <i>int16</i>	Data storage parameter 24.	0
	-32768 ... 32767	16-bit data.	1 = 1

No.	Name/Value	Description	Def/FbEq16
<b>49 Panel port communication</b>		Communication settings for the control panel port on the drive.	
49.01	<i>Node ID number</i>	Defines the node ID of the drive. All devices connected to the network must have a unique node ID. <b>Note:</b> For networked drives, it is advisable to reserve ID 1 for spare/replacement drives.	1
	1...32	Node ID.	1 = 1
49.03	<i>Baud rate</i>	Defines the transfer rate of the link.	<i>230.4 kbps</i>
	38.4 kbps	38.4 kbit/s.	1
	57.6 kbps	57.6 kbit/s.	2
	86.4 kbps	86.4 kbit/s.	3
	115.2 kbps	115.2 kbit/s.	4
	230.4 kbps	230.4 kbit/s.	5
49.04	<i>Communication loss time</i>	Sets a timeout for control panel (or PC tool) communication. If a communication break lasts longer than the timeout, the action specified by parameter <i>49.05 Communication loss action</i> is taken.	10.0 s
	0.1 ... 3000.0 s	Panel/PC tool communication timeout.	10 = 1 s
49.05	<i>Communication loss action</i>	Selects how the drive reacts to a control panel (or PC tool) communication break.	<i>Fault</i>
	No action	No action taken.	0
	Fault	Drive trips on <i>7081 Panel port communication</i> .	1
	Last speed	Drive generates an <i>A7EE Panel loss</i> warning and freezes the speed to the level the drive was operating at. The speed is determined on the basis of actual speed using 850 ms low-pass filtering.  <b>WARNING!</b> Make sure that it is safe to continue operation in case of a communication break.	2
	Speed ref safe	Drive generates an <i>A7EE Panel loss</i> warning and sets the speed to the speed defined by parameter <i>22.41 Speed ref safe</i> (or <i>28.41 Frequency ref safe</i> when frequency reference is used).  <b>WARNING!</b> Make sure that it is safe to continue operation in case of a communication break.	3
49.06	<i>Refresh settings</i>	Applies the settings of parameters <i>49.01...49.05</i> . <b>Note:</b> Refreshing may cause a communication break, so reconnecting the drive may be required.	<i>Done</i>
	Done	Refresh done or not requested.	0
	Configure	Refresh parameters <i>49.01...49.05</i> . The value reverts automatically to <i>Done</i> .	1
<b>50 Fieldbus adapter (FBA)</b>		Fieldbus communication configuration.	
50.01	<i>FBA A enable</i>	Enables/disables communication between the drive and fieldbus adapter A.	<i>Disable</i>
	Disable	Communication between drive and fieldbus adapter A disabled.	0
	Enable	Communication between drive and fieldbus adapter A enabled.	1

No.	Name/Value	Description	Def/FbEq16
50.02	<i>FBA A comm loss func</i>	Selects how the drive reacts upon a fieldbus communication break. The time delay is defined by parameter <i>50.03 FBA A comm loss timeout</i> .	<i>No action</i>
	No action	No action taken.	0
	Fault	Communication break detection active. Upon a communication break, the drive trips on a <i>7510 FBA A communication</i> fault and coasts to a stop.	1
	Last speed	Communication break detection active. Upon a communication break, the drive generates a warning ( <i>A7C1 FBA A communication</i> ) and freezes the speed to the level the drive was operating at. The speed is determined on the basis of actual speed using 850 ms low-pass filtering.  <b>WARNING!</b> Make sure that it is safe to continue operation in case of a communication break.	2
	Speed ref safe	Communication break detection active. Upon a communication break, the drive generates a warning ( <i>A7C1 FBA A communication</i> ) and sets the speed to the value defined by parameter <i>22.41 Speed ref safe</i> (or <i>28.41 Frequency ref safe</i> when frequency reference is used).  <b>WARNING!</b> Make sure that it is safe to continue operation in case of a communication break.	3
50.03	<i>FBA A comm loss timeout</i>	Defines the time delay before the action defined by parameter <i>50.02 FBA A comm loss func</i> is taken. Time count starts when the communication link fails to update the message.	0.3 s
	0.3 ... 6553.5 s	Time delay.	1 = 1 s
50.04	<i>FBA A ref1 type</i>	Selects the type and scaling of reference 1 received from fieldbus adapter A. The scaling of the reference is defined by parameters <i>46.01...46.04</i> , depending on which reference type is selected by this parameter.	<i>Auto</i>
	Auto	Type and scaling is chosen automatically according to the currently active control mode.	0
	Transparent	No scaling is applied.	1
	General	Generic reference without a specific unit.	2
	Torque	The scaling is defined by parameter <i>46.03 Torque scaling</i> .	3
	Speed	The scaling is defined by parameter <i>46.01 Speed scaling</i> .	4
	Frequency	The scaling is defined by parameter <i>46.02 Frequency scaling</i> .	5
	Position	Reserved.	6
	Velocity	Reserved.	7
	DC voltage	Reserved.	8
	Active power	Reserved.	9
	Reactive power	Reserved.	10
50.05	<i>FBA A ref2 type</i>	Selects the type and scaling of reference 2 received from fieldbus adapter A. The scaling of the reference is defined by parameters <i>46.01...46.04</i> , depending on which reference type is selected by this parameter. For the selections, see parameter <i>50.04 FBA A ref1 type</i> .	<i>Auto</i>
50.06	<i>FBA A SW sel</i>	Selects the source of the Status word to be sent to the fieldbus network through fieldbus adapter A.	<i>Auto</i>
	Auto	Source of the Status word is chosen automatically.	0

No.	Name/Value	Description	Def/FbEq16
	Transparent mode	The source selected by parameter <a href="#">50.09 FBA A SW transparent source</a> is transmitted as the Status word to the fieldbus network through fieldbus adapter A.	1
<a href="#">50.07</a>	<a href="#">FBA A actual 1 type</a>	Selects the type and scaling of actual value 1 transmitted to the fieldbus network through fieldbus adapter A. The scaling of the value is defined by parameters <a href="#">46.01...46.04</a> , depending on which actual value type is selected by this parameter. For the selections, see parameter <a href="#">50.04 FBA A ref1 type</a> .	<i>Auto</i>
<a href="#">50.08</a>	<a href="#">FBA A actual 2 type</a>	Selects the type and scaling of actual value 2 transmitted to the fieldbus network through fieldbus adapter A. The scaling of the value is defined by parameters <a href="#">46.01...46.04</a> , depending on which actual value type is selected by this parameter. For the selections, see parameter <a href="#">50.04 FBA A ref1 type</a> .	<i>Auto</i>
<a href="#">50.09</a>	<a href="#">FBA A SW transparent source</a>	Selects the source of the fieldbus status word when parameter <a href="#">50.06 FBA A SW sel</a> is set to <i>Transparent mode</i> .	<i>Not selected</i>
	Not selected	No source selected.	-
	Other	The value is taken from another parameter.	-
<a href="#">50.10</a>	<a href="#">FBA A act1 transparent source</a>	When parameter <a href="#">50.07 FBA A actual 1 type</a> is set to <i>Transparent</i> , this parameter selects the source of actual value 1 transmitted to the fieldbus network through fieldbus adapter A.	<i>Not selected</i>
	Not selected	No source selected.	-
	Other	The value is taken from another parameter.	-
<a href="#">50.11</a>	<a href="#">FBA A act2 transparent source</a>	When parameter <a href="#">50.08 FBA A actual 2 type</a> is set to <i>Transparent</i> , this parameter selects the source of actual value 2 transmitted to the fieldbus network through fieldbus adapter A.	<i>Not selected</i>
	Not selected	No source selected.	-
	Other	The value is taken from another parameter.	-
<a href="#">50.12</a>	<a href="#">FBA A debug enable</a>	Enables the display of raw (unmodified) data received from and sent to fieldbus adapter A in parameters <a href="#">50.13...50.18</a> . This functionality should only be used for debugging.	<i>Disable</i>
	Disable	Display of raw data from fieldbus adapter A disabled.	0
	Enable	Display of raw data from fieldbus adapter A enabled.	1
<a href="#">50.13</a>	<a href="#">FBA A control word</a>	Displays the raw (unmodified) control word sent by the master (PLC) to fieldbus adapter A if debugging is enabled by parameter <a href="#">50.12 FBA A debug enable</a> . This parameter is read-only.	-
	00000000h ... FFFFFFFFh	Control word sent by master to fieldbus adapter A.	-
<a href="#">50.14</a>	<a href="#">FBA A reference 1</a>	Displays raw (unmodified) reference REF1 sent by the master (PLC) to fieldbus adapter A if debugging is enabled by parameter <a href="#">50.12 FBA A debug enable</a> . This parameter is read-only.	-
	-2147483648 ... 2147483647	Raw REF1 sent by master to fieldbus adapter A.	-

No.	Name/Value	Description	Def/FbEq16															
50.15	<i>FBA A reference 2</i>	Displays raw (unmodified) reference REF2 sent by the master (PLC) to fieldbus adapter A if debugging is enabled by parameter <a href="#">50.12 FBA A debug enable</a> . This parameter is read-only.	-															
	-2147483648 ... 2147483647	Raw REF2 sent by master to fieldbus adapter A.	-															
50.16	<i>FBA A status word</i>	Displays the raw (unmodified) status word sent by fieldbus adapter A to the master (PLC) if debugging is enabled by parameter <a href="#">50.12 FBA A debug enable</a> . This parameter is read-only.	-															
	00000000h ... FFFFFFFFh	Status word sent by fieldbus adapter A to master.	-															
50.17	<i>FBA A actual value 1</i>	Displays raw (unmodified) actual value ACT1 sent by fieldbus adapter A to the master (PLC) if debugging is enabled by parameter <a href="#">50.12 FBA A debug enable</a> . This parameter is read-only.	-															
	-2147483648 ... 2147483647	Raw ACT1 sent by fieldbus adapter A to master.	-															
50.18	<i>FBA A actual value 2</i>	Displays raw (unmodified) actual value ACT2 sent by fieldbus adapter A to the master (PLC) if debugging is enabled by parameter <a href="#">50.12 FBA A debug enable</a> . This parameter is read-only.	-															
	-2147483648 ... 2147483647	Raw ACT2 sent by fieldbus adapter A to master.	-															
50.21	<i>FBA A timelevel sel</i>	<p>Selects the communication time levels. In general, lower time levels of read/write services reduce CPU load. The table below shows the time levels of the read/write services for cyclic high and cyclic low data with each parameter setting.</p> <table border="1"> <thead> <tr> <th>Selection</th> <th>Cyclic high *</th> <th>Cyclic low **</th> </tr> </thead> <tbody> <tr> <td><i>Slow</i></td> <td>10 ms</td> <td>10 ms</td> </tr> <tr> <td><i>Normal</i></td> <td>2 ms</td> <td>10 ms</td> </tr> <tr> <td><i>Fast</i></td> <td>500 µs</td> <td>2 ms</td> </tr> <tr> <td><i>Very fast</i></td> <td>250 µs</td> <td>2 ms</td> </tr> </tbody> </table> <p>* Cyclic high data consists of fieldbus Control and Status words, Ref1, Ref2, Act1 and Act2. ** Cyclic low data consists of the parameter data mapped to parameter groups <a href="#">52 FBA A data in</a> and <a href="#">53 FBA A data out</a>. Acyclic data is handled as a background task.</p>	Selection	Cyclic high *	Cyclic low **	<i>Slow</i>	10 ms	10 ms	<i>Normal</i>	2 ms	10 ms	<i>Fast</i>	500 µs	2 ms	<i>Very fast</i>	250 µs	2 ms	<i>Normal</i>
Selection	Cyclic high *	Cyclic low **																
<i>Slow</i>	10 ms	10 ms																
<i>Normal</i>	2 ms	10 ms																
<i>Fast</i>	500 µs	2 ms																
<i>Very fast</i>	250 µs	2 ms																
	Slow	Slow speed.	3															
	Normal	Normal speed.	0															
	Fast	Fast speed.	1															
	Very fast	Very fast speed.	2															

No.	Name/Value	Description	Def/FbEq16
<b>51 FBA A settings</b>		Fieldbus adapter A configuration.	
<b>51.01</b>	<b>FBA type</b>	Displays the type of the connected fieldbus adapter module. <b>0</b> = Module is not found or is not properly connected, or is disabled by parameter <b>50.01 FBA A enable</b> ; <b>1</b> = FPBA; <b>32</b> = FCAN; <b>37</b> = FDNA; <b>128</b> = FENA-11; <b>135</b> = FECA; <b>136</b> = FEPL; <b>485</b> = FSCA. This parameter is read-only.	-
<b>51.02</b>	<b>FBA Par2</b>	Parameters <b>51.02...51.26</b> are adapter module-specific. For more information, see the documentation of the fieldbus adapter module. Note that not all of these parameters are necessarily in use.	-
	0...65535	Fieldbus adapter configuration parameter.	1 = 1
	...	...	...
<b>51.26</b>	<b>FBA Par26</b>	See parameter <b>51.02 FBA Par2</b> .	-
	0...65535	Fieldbus adapter configuration parameter.	1 = 1
<b>51.27</b>	<b>FBA par refresh</b>	Validates any changed fieldbus adapter module configuration settings. After refreshing, the value reverts automatically to <b>Done</b> . <b>Note:</b> This parameter cannot be changed while the drive is running.	<b>Done</b>
	Done	Refreshing done.	0
	Configure	Refreshing.	1
<b>51.28</b>	<b>Par table ver</b>	Displays the parameter table revision of the fieldbus adapter module mapping file (stored in the memory of the drive). In format axyz, where ax = major table revision number; yz = minor table revision number. This parameter is read-only.	-
		Parameter table revision of adapter module.	-
<b>51.29</b>	<b>Drive type code</b>	Displays the drive type code in the fieldbus adapter module mapping file (stored in the memory of the drive). This parameter is read-only.	-
	0...65535	Drive type code stored in the mapping file.	1 = 1
<b>51.30</b>	<b>Mapping file ver</b>	Displays the fieldbus adapter module mapping file revision stored in the memory of the drive in decimal format. This parameter is read-only.	-
	0...65535	Mapping file revision.	1 = 1
<b>51.31</b>	<b>D2FBA comm sta</b>	Displays the status of the fieldbus adapter module communication.	-
	Idle	Adapter is not configured.	0
	Exec.init	Adapter is initializing.	1
	Time out	A timeout has occurred in the communication between the adapter and the drive.	2
	Conf.err	Adapter configuration error: mapping file not found in the file system of the drive, or mapping file upload has failed more than three times.	3
	Off-line	Fieldbus communication is off-line.	4



No.	Name/Value	Description	Def/FbEq16
	On-line	Fieldbus communication is on-line, or fieldbus adapter has been configured not to detect a communication break. For more information, see the documentation of the fieldbus adapter.	5
	Reset	Adapter is performing a hardware reset.	6
<b>51.32</b>	<b><i>FBA comm SW ver</i></b>	Displays the common program revision of the adapter module in format axyz, where a = major revision number, xy = minor revision number, z = correction number or letter. Example: 190A = revision 1.90A.	
		Common program revision of adapter module.	-
<b>51.33</b>	<b><i>FBA appl SW ver</i></b>	Displays the application program revision of the adapter module in format axyz, where a = major revision number, xy = minor revision number, z = correction number or letter. Example: 190A = revision 1.90A.	
		Application program version of adapter module.	-
<b>52 FBA A data in</b>		Selection of data to be transferred from drive to fieldbus controller through fieldbus adapter A. <b>Note:</b> 32-bit values require two consecutive parameters. Whenever a 32-bit value is selected in a data parameter, the next parameter is automatically reserved.	
<b>52.01</b>	<b><i>FBA data in1</i></b>	Parameters <b>52.01...52.12</b> select data to be transferred from the drive to the fieldbus controller through fieldbus adapter A.	<b>None</b>
	None	None.	0
	CW 16bit	Control Word (16 bits)	1
	Ref1 16bit	Reference REF1 (16 bits)	2
	Ref2 16bit	Reference REF2 (16 bits)	3
	SW 16bit	Status Word (16 bits)	4
	Act1 16bit	Actual value ACT1 (16 bits)	5
	Act2 16bit	Actual value ACT2 (16 bits)	6
	CW 32bit	Control Word (32 bits)	11
	Ref1 32bit	Reference REF1 (32 bits)	12
	Ref2 32bit	Reference REF2 (32 bits)	13
	SW 32bit	Status Word (32 bits)	14
	Act1 32bit	Actual value ACT1 (32 bits)	15
	Act2 32bit	Actual value ACT2 (32 bits)	16
	SW2 16bit	Status Word 2 (16 bits)	24
	Other	The value is taken from another parameter.	-
...	...	...	...
<b>52.12</b>	<b><i>FBA data in12</i></b>	See parameter <b>52.01 FBA data in1</b> .	<b>None</b>



No.	Name/Value	Description	Def/FbEq16
<b>53 FBA A data out</b>		Selection of data to be transferred from fieldbus controller to drive through fieldbus adapter A. <b>Note:</b> 32-bit values require two consecutive parameters. Whenever a 32-bit value is selected in a data parameter, the next parameter is automatically reserved.	
<b>53.01</b>	<b>FBA data out1</b>	Parameters <b>53.01</b> ... <b>53.12</b> select data to be transferred from the fieldbus controller to the drive through fieldbus adapter A.	<i>None</i>
	None	None.	0
	CW 16bit	Control Word (16 bits)	1
	Ref1 16bit	Reference REF1 (16 bits)	2
	Ref2 16bit	Reference REF2 (16 bits)	3
	CW 32bit	Control Word (32 bits)	11
	Ref1 32bit	Reference REF1 (32 bits)	12
	Ref2 32bit	Reference REF2 (32 bits)	13
	CW2 16bit	Control Word 2 (16 bits)	21
	Other	The value is taken from another parameter.	-
...	...	...	...
<b>53.12</b>	<b>FBA data out12</b>	See parameter <b>53.01 FBA data out1</b> .	<i>None</i>
<b>60 D2D and DDCS communication</b>		DDCS (fiber optic) communication configuration. Fiber optic links connected to DDCS channels can be used to <ul style="list-style-type: none"> <li>connect drives together to build a master/follower network</li> <li>connect the drive to an external controller such as the AC 800M.</li> <li>See also sections <i>Master/follower functionality</i> (page 27) and <i>External controller interface</i> (page 32).</li> </ul>	
<b>60.01</b>	<b>M/F communication port</b>	Selects the DDCS channel used for master/follower communication.	<i>No connect</i>
	No connect	None (communication disabled).	0
	Slot 1A	Channel A on FDCO module in slot 1 (with ZCU control unit only).	1
	Slot 2A	Channel A on FDCO module in slot 2 (with ZCU control unit only).	2
	Slot 3A	Channel A on FDCO module in slot 3 (with ZCU control unit only).	3
	Slot 1B	Channel B on FDCO module in slot 1 (with ZCU control unit only).	4
	Slot 2B	Channel B on FDCO module in slot 2 (with ZCU control unit only).	5
	Slot 3B	Channel B on FDCO module in slot 3 (with ZCU control unit only).	6
	RDCO CH2	Channel 2 on RDCO module (with BCU control unit only).	12
<b>60.02</b>	<b>M/F node address</b>	Selects the node address of the drive for master/follower communication. No two nodes on-line may have the same address. <b>Note:</b> The allowable addresses for the master are 0 and 1. The allowable addresses for followers are 2...60.	1
	1...254	Node address.	

No.	Name/Value	Description	Def/FbEq16
<a href="#">60.03</a>	<a href="#">M/F mode</a>	Defines the role of the drive on the master/follower link.	<a href="#">NotInUse</a>
	NotInUse	Master/follower link not active.	0
	Master	The drive is the master on the master/follower link.	1
	Follower	The drive is a follower on the master/follower link.	2
<a href="#">60.05</a>	<a href="#">M/F HW connection</a>	Selects the topology of the master/follower link.	<a href="#">Star</a>
	Ring	The devices are connected in a ring topology. Forwarding of messages is enabled.	0
	Star	The devices are connected in a star topology (for example, through a branching unit). Forwarding of messages is disabled.	1
<a href="#">60.07</a>	<a href="#">M/F link control</a>	Defines the light intensity of the transmission LEDs. In general, use higher values with longer fiber optic cables. The maximum setting is applicable to the maximum length of the fiber optic link. See <a href="#">Specifications of the master/follower link</a> (page 32).	10
	1...15	Light intensity.	
<a href="#">60.08</a>	<a href="#">M/F comm loss timeout</a>	Sets a timeout for master/follower communication. If a communication break lasts longer than the timeout, the action specified by parameter <a href="#">60.09 M/F comm loss function</a> is taken.	4 ms
	0...65535 ms	Master/follower communication timeout.	
<a href="#">60.09</a>	<a href="#">M/F comm loss function</a>	Selects how the drive reacts to a master/follower communication break.	<a href="#">Fault</a>
	NoAction	No action taken.	0
	Warning	The drive generates a warning ( <a href="#">A7CB MF comm loss</a> ).	1
	Fault	Drive trips on <a href="#">7582 MF comm loss</a> .	2
<a href="#">60.10</a>	<a href="#">M/F ref1 type</a>	Selects the type and scaling of reference 1 received from the master/follower link. The scaling of the reference is defined by parameters <a href="#">46.01...46.04</a> , depending on which reference type is selected by this parameter. The resulting value is shown by <a href="#">03.13 M/F or D2D ref1</a> .	<a href="#">Auto</a>
	Auto	Type and scaling is chosen automatically according to the currently active control mode.	0
	Transparent	No scaling is applied.	1
	General	Generic reference without a specific unit.	2
	Torque	The scaling is defined by parameter <a href="#">46.03 Torque scaling</a> .	3
	Speed	The scaling is defined by parameter <a href="#">46.01 Speed scaling</a> .	4
	Frequency	The scaling is defined by parameter <a href="#">46.02 Frequency scaling</a> .	5
	Position	Reserved.	6
	Velocity	Reserved.	7
	DC voltage	Reserved.	8
	Active power	Reserved.	9
	Reactive power	Reserved.	10

No.	Name/Value	Description	Def/FbEq16
60.11	<i>M/F ref2 type</i>	Selects the type and scaling of reference 2 received from the master/follower link. The scaling of the reference is defined by parameters <a href="#">46.01</a> ... <a href="#">46.04</a> , depending on which reference type is selected by this parameter. The resulting value is shown by <a href="#">03.14 M/F or D2D ref2</a> . For the selections, see parameter <a href="#">60.10 M/F ref1 type</a> .	<i>Auto</i>
60.12	<i>M/F act1 type</i>	Selects the type and scaling of actual value 1 transmitted to the master/follower link. The scaling of the value is defined by parameters <a href="#">46.01</a> ... <a href="#">46.04</a> , depending on which actual value type is selected by this parameter. For the selections, see parameter <a href="#">60.10 M/F ref1 type</a> .	<i>Auto</i>
60.13	<i>M/F act2 type</i>	Selects the type and scaling of actual value 2 transmitted to the master/follower link. The scaling of the value is defined by parameters <a href="#">46.01</a> ... <a href="#">46.04</a> , depending on which actual value type is selected by this parameter. For the selections, see parameter <a href="#">60.10 M/F ref1 type</a> .	<i>Auto</i>
60.14	<i>M/F follower selection</i>	(Effective in the master only.) Defines the followers from which data is read. See also parameters <a href="#">62.28</a> ... <a href="#">62.33</a> .	<i>None</i>
	None	None.	0
	Follower node 2	Data is read from the follower with node address 2.	2
	Follower node 3	Data is read from the follower with node address 3.	4
	Follower nodes 2+3	Data is read from the followers with node addresses 2 and 3.	6
	Follower node 4	Data is read from the follower with node address 4.	8
	Follower nodes 2+4	Data is read from the followers with node addresses 2 and 4.	10
	Follower nodes 3+4	Data is read from the followers with node addresses 3 and 4.	12
	Follower nodes 2+3+4	Data is read from the followers with node addresses 2, 3 and 4.	14
60.51	<i>DDCS controller comm port</i>	Selects the DDCS channel used for connecting an external controller (such as an AC 800M).	<i>No connect</i>
	No connect	None (communication disabled).	0
	Slot 1A	Channel A on FDCO module in slot 1 (with ZCU control unit only).	1
	Slot 2A	Channel A on FDCO module in slot 2 (with ZCU control unit only).	2
	Slot 3A	Channel A on FDCO module in slot 3 (with ZCU control unit only).	3
	Slot 1B	Channel B on FDCO module in slot 1 (with ZCU control unit only).	4
	Slot 2B	Channel B on FDCO module in slot 2 (with ZCU control unit only).	5
	Slot 3B	Channel B on FDCO module in slot 3 (with ZCU control unit only).	6
	RDCO CH0	Channel 0 on RDCO module (with BCU control unit only).	11
60.52	<i>DDCS controller node address</i>	Selects the node address of the drive for communication with the external controller. No two nodes on-line may have the same address.	1
	1...254	Node address.	

No.	Name/Value	Description	Def/FbEq16
60.55	<i>DDCS controller HW connection</i>	Selects the topology of the fiber optic link.	<i>Star</i>
	Ring	The devices are connected in a ring topology. Forwarding of messages is enabled.	0
	Star	The devices are connected in a star topology (for example, through a branching unit). Forwarding of messages is disabled.	1
60.57	<i>DDCS controller link control</i>	Defines the light intensity of the transmission LEDs. In general, use higher values with longer fiber optic cables. The maximum setting is applicable to the maximum length of the fiber optic link. See <i>Specifications of the master/follower link</i> (page 32).	10
	1...15	Light intensity.	
60.58	<i>DDCS controller comm loss time</i>	Sets a timeout for communication with the external controller. If a communication break lasts longer than the timeout, the action specified by parameter 60.59 <i>DDCS controller comm loss action</i> is taken.	2000 ms
	0...60000 ms	Timeout for communication with external controller.	
60.59	<i>DDCS controller comm loss action</i>	Selects how the drive reacts to a communication break between the drive and the external controller.	<i>Fault</i>
	No action	No action taken.	0
	Fault	Drive trips on <i>7581 DDCS controller comm loss</i> .	1
	Last speed	Drive generates an <i>A7CA DDCS controller comm loss</i> warning and freezes the speed to the level the drive was operating at. The speed is determined on the basis of actual speed using 850 ms low-pass filtering.  <b>WARNING!</b> Make sure that it is safe to continue operation in case of a communication break.	2
	Speed ref safe	Drive generates an <i>A7CA DDCS controller comm loss</i> warning and sets the speed to the speed defined by parameter 22.41 <i>Speed ref safe</i> (or 28.41 <i>Frequency ref safe</i> when frequency reference is used).  <b>WARNING!</b> Make sure that it is safe to continue operation in case of a communication break.	3
60.60	<i>DDCS controller ref1 type</i>	Selects the type and scaling of reference 1 received from the external controller. The scaling of the reference is defined by parameters 46.01...46.04, depending on which reference type is selected by this parameter. The resulting value is shown by 03.11 <i>DDCS controller ref 1</i> .	<i>Auto</i>
	Auto	Type and scaling is chosen automatically according to the currently active control mode.	0
	Transparent	No scaling is applied.	1
	General	Generic reference without a specific unit.	2
	Torque	The scaling is defined by parameter 46.03 <i>Torque scaling</i> .	3
	Speed	The scaling is defined by parameter 46.01 <i>Speed scaling</i> .	4
	Frequency	The scaling is defined by parameter 46.02 <i>Frequency scaling</i> .	5
	Position	Reserved.	6
	Velocity	Reserved.	7
	DC voltage	Reserved.	8
	Active power	Reserved.	9

No.	Name/Value	Description	Def/FbEq16
	Reactive power	Reserved.	10
60.61	<i>DDCS controller ref2 type</i>	Selects the type and scaling of reference 2 received from the external controller. The scaling of the reference is defined by parameters <a href="#">46.01</a> ... <a href="#">46.04</a> , depending on which reference type is selected by this parameter. The resulting value is shown by <a href="#">03.12 DDCS controller ref 2</a> . For the selections, see parameter <a href="#">60.60 DDCS controller ref1 type</a> .	Auto
60.62	<i>DDCS controller act1 type</i>	Selects the type and scaling of actual value 1 transmitted to the external controller. The scaling of the value is defined by parameters <a href="#">46.01</a> ... <a href="#">46.04</a> , depending on which actual value type is selected by this parameter. For the selections, see parameter <a href="#">60.60 DDCS controller ref1 type</a> .	Auto
60.63	<i>DDCS controller act2 type</i>	Selects the type and scaling of actual value 2 transmitted to the external controller. The scaling of the value is defined by parameters <a href="#">46.01</a> ... <a href="#">46.04</a> , depending on which actual value type is selected by this parameter. For the selections, see parameter <a href="#">60.60 DDCS controller ref1 type</a> .	Auto
<b>61 D2D and DDCS transmit data</b>		Defines the data sent to the DDCS link. See also parameter group <a href="#">60 D2D and DDCS communication</a> .	
61.01	<i>M/F data 1 selection</i>	Preselects the data to be sent as word 1 onto the master/follower link. See also parameter <a href="#">61.25 M/F data 1 value</a> .	None
	None	None.	0
	CW 16bit	Control Word (16 bits)	1
	SW 16bit	Status Word (16 bits)	4
	Act1 16bit	Actual value ACT1 (16 bits)	5
	Act2 16bit	Actual value ACT2 (16 bits)	6
	Other	The value is taken from another parameter.	-
61.02	<i>M/F data 2 selection</i>	Preselects the data to be sent as word 2 onto the master/follower link. See also parameter <a href="#">61.26 M/F data 2 value</a> . For the selections, see parameter <a href="#">61.01 M/F data 1 selection</a> .	None
61.03	<i>M/F data 3 selection</i>	Preselects the data to be sent as word 3 onto the master/follower link. See also parameter <a href="#">61.27 M/F data 3 value</a> . For the selections, see parameter <a href="#">61.01 M/F data 1 selection</a> .	None
61.25	<i>M/F data 1 value</i>	Displays the data to be sent onto the master/follower link as word 1 as an integer. If no data has been preselected by <a href="#">61.01 M/F data 1 selection</a> , the value to be sent can be written directly into this parameter.	0
	0...65535	Data to be sent as word 1 in master/follower communication.	

No.	Name/Value	Description	Def/FbEq16
61.26	<i>M/F data 2 value</i>	Displays the data to be sent onto the master/follower link as word 2 as an integer. If no data has been preselected by <i>61.02 M/F data 2 selection</i> , the value to be sent can be written directly into this parameter.	0
	0...65535	Data to be sent as word 2 in master/follower communication.	
61.27	<i>M/F data 3 value</i>	Displays the data to be sent onto the master/follower link as word 3 as an integer. If no data has been preselected by <i>61.03 M/F data 3 selection</i> , the value to be sent can be written directly into this parameter.	0
	0...65535	Data to be sent as word 3 in master/follower communication.	
61.51	<i>Data set 11 data 1 selection</i>	Parameters <i>61.51...61.74</i> preselect data to be sent in datasets 11, 13, 15, 17, 19, 21, 23 and 25 to the external controller. Parameters <i>61.101...61.124</i> display the data to be sent to the external controller. If no data has been preselected, the value to be sent can be written directly into these parameters. For example, this parameter preselects the data for word 1 of dataset 11. Parameter <i>61.101 Data set 11 data 1 value</i> displays the selected data in integer format. If no data is preselected, the value to be sent can be written directly into parameter <i>61.101</i> .	<i>None</i>
	None	None.	0
	CW 16bit	Control Word (16 bits)	1
	SW 16bit	Status Word (16 bits)	4
	Act1 16bit	Actual value ACT1 (16 bits)	5
	Act2 16bit	Actual value ACT2 (16 bits)	6
	Other	The value is taken from another parameter.	-
61.52	<i>Data set 11 data 2 selection</i>	Preselects the data to be sent as word 2 of dataset 11 to the external controller. See also parameter <i>61.102 Data set 11 data 2 value</i> . For the selections, see parameter <i>61.51 Data set 11 data 1 selection</i> .	<i>None</i>
61.53	<i>Data set 11 data 3 selection</i>	Preselects the data to be sent as word 3 of dataset 11 to the external controller. See also parameter <i>61.103 Data set 11 data 3 value</i> . For the selections, see parameter <i>61.51 Data set 11 data 1 selection</i> .	<i>None</i>
61.54	<i>Data set 13 data 1 selection</i>	See parameter <i>61.51 Data set 11 data 1 selection</i> .	<i>None</i>
...	...	...	...
61.74	<i>Data set 25 data 3 selection</i>	See parameter <i>61.51 Data set 11 data 1 selection</i> .	<i>None</i>
61.101	<i>Data set 11 data 1 value</i>	Displays (in integer format) the data to be sent to the external controller as word 1 of dataset 11. If no data has been preselected by <i>61.51 Data set 11 data 1 selection</i> , the value to be sent can be written directly into this parameter.	0
	0...65535	Data to be sent as word 1 of dataset 11.	

No.	Name/Value	Description	Def/FbEq16
61.102	<a href="#">Data set 11 data 2 value</a>	Displays (in integer format) the data to be sent to the external controller as word 2 of dataset 11. If no data has been preselected by <a href="#">61.52 Data set 11 data 2 selection</a> , the value to be sent can be written directly into this parameter.	0
	0...65535	Data to be sent as word 2 of dataset 11.	
61.103	<a href="#">Data set 11 data 3 value</a>	Displays (in integer format) the data to be sent to the external controller as word 3 of dataset 11. If no data has been selected by <a href="#">61.53 Data set 11 data 3 selection</a> , the value to be sent can be written directly into this parameter.	0
	0...65535	Data to be sent as word 3 of dataset 11.	
61.104	<a href="#">Data set 13 data 1 value</a>	Displays (in integer format) the data to be sent to the external controller as word 1 of dataset 13. If no data has been selected by <a href="#">61.54 Data set 13 data 1 selection</a> , the value to be sent can be written directly into this parameter.	0
	0...65535	Data to be sent as word 1 of dataset 13.	
...	...	...	...
61.124	<a href="#">Data set 25 data 3 value</a>	Displays (in integer format) the data to be sent to the external controller as word 3 of dataset 25. If no data has been selected by <a href="#">61.74 Data set 25 data 3 selection</a> , the value to be sent can be written directly into this parameter.	0
	0...65535	Data to be sent as word 3 of dataset 25.	
<b>62 D2D and DDCCS receive data</b>		Mapping of data received through the DDCCS link. See also parameter group <a href="#">60 D2D and DDCCS communication</a> .	
62.01	<a href="#">M/F data 1 selection</a>	(Follower only) Defines a target for the data received as word 1 from the master through the master/follower link. See also parameter <a href="#">62.25 MF/D2D data 1 value</a> .	<i>None</i>
	None	None.	0
	CW 16bit	Control Word (16 bits)	1
	Ref1 16bit	Reference REF1 (16 bits)	2
	Ref2 16bit	Reference REF2 (16 bits)	3
	Other	The value is taken from another parameter.	-
62.02	<a href="#">M/F data 2 selection</a>	(Follower only) Defines a target for the data received as word 2 from the master through the master/follower link. See also parameter <a href="#">62.26 MF/D2D data 2 value</a> . For the selections, see parameter <a href="#">62.01 M/F data 1 selection</a> .	<i>None</i>
62.03	<a href="#">M/F data 3 selection</a>	(Follower only) Defines a target for the data received as word 3 from the master through the master/follower link. See also parameter <a href="#">62.27 MF/D2D data 3 value</a> . For the selections, see parameter <a href="#">62.01 M/F data 1 selection</a> .	<i>None</i>
62.04	<a href="#">Follower node 2 data 1 sel</a>	Defines a target for the data received as word 1 from the first follower (ie. the follower with node address 2) through the master/follower link. See also parameter <a href="#">62.28 Follower node 2 data 1 value</a> . For the selections, see parameter <a href="#">62.01 M/F data 1 selection</a> .	<i>None</i>

## 240 Parameters

No.	Name/Value	Description	Def/FbEq16
62.05	<i>Follower node 2 data 2 sel</i>	Defines a target for the data received as word 2 from the first follower (ie. the follower with node address 2) through the master/follower link. See also parameter <a href="#">62.29 Follower node 2 data 2 value</a> . For the selections, see parameter <a href="#">62.01 M/F data 1 selection</a> .	<i>None</i>
62.06	<i>Follower node 2 data 3 sel</i>	Defines a target for the data received as word 3 from the first follower (ie. the follower with node address 2) through the master/follower link. See also parameter <a href="#">62.30 Follower node 2 data 3 value</a> . For the selections, see parameter <a href="#">62.01 M/F data 1 selection</a> .	<i>None</i>
62.07	<i>Follower node 3 data 1 sel</i>	Defines a target for the data received as word 1 from the second follower (ie. the follower with node address 3) through the master/follower link. See also parameter <a href="#">62.31 Follower node 3 data 1 value</a> . For the selections, see parameter <a href="#">62.01 M/F data 1 selection</a> .	<i>None</i>
62.08	<i>Follower node 3 data 2 sel</i>	Defines a target for the data received as word 2 from the second follower (ie. the follower with node address 3) through the master/follower link. See also parameter <a href="#">62.32 Follower node 3 data 2 value</a> . For the selections, see parameter <a href="#">62.01 M/F data 1 selection</a> .	<i>None</i>
62.09	<i>Follower node 3 data 3 sel</i>	Defines a target for the data received as word 3 from the second follower (ie. the follower with node address 3) through the master/follower link. See also parameter <a href="#">62.33 Follower node 3 data 3 value</a> . For the selections, see parameter <a href="#">62.01 M/F data 1 selection</a> .	<i>None</i>
62.10	<i>Follower node 4 data 1 sel</i>	Defines a target for the data received as word 1 from the third follower (ie. the follower with node address 4) through the master/follower link. See also parameter <a href="#">62.34 Follower node 4 data 1 value</a> . For the selections, see parameter <a href="#">62.01 M/F data 1 selection</a> .	<i>None</i>
62.11	<i>Follower node 4 data 2 sel</i>	Defines a target for the data received as word 2 from the third follower (ie. the follower with node address 4) through the master/follower link. See also parameter <a href="#">62.35 Follower node 4 data 2 value</a> . For the selections, see parameter <a href="#">62.01 M/F data 1 selection</a> .	<i>None</i>
62.12	<i>Follower node 4 data 3 sel</i>	Defines a target for the data received as word 3 from the third follower (ie. the follower with node address 4) through the master/follower link. See also parameter <a href="#">62.36 Follower node 4 data 3 value</a> . For the selections, see parameter <a href="#">62.01 M/F data 1 selection</a> .	<i>None</i>
62.25	<i>MF/D2D data 1 value</i>	(Follower only) Displays, in integer format, the data received from the master as word 1. Parameter <a href="#">62.01 M/F data 1 selection</a> can be used to select a target for the received data. This parameter can also be used as a signal source by other parameters.	0
	0...65535	Data received as word 1 in master/follower communication.	
62.26	<i>MF/D2D data 2 value</i>	(Follower only) Displays, in integer format, the data received from the master as word 2. Parameter <a href="#">62.02 M/F data 2 selection</a> can be used to select a target for the received data. This parameter can also be used as a signal source by other parameters.	0
	0...65535	Data received as word 2 in master/follower communication.	



No.	Name/Value	Description	Def/FbEq16
62.27	<i>MF/D2D data 3 value</i>	(Follower only) Displays, in integer format, the data received from the master as word 3. Parameter <a href="#">62.03 M/F data 3 selection</a> can be used to select a target for the received data. This parameter can also be used as a signal source by other parameters.	0
	0...65535	Data received as word 3 in master/follower communication.	
62.28	<i>Follower node 2 data 1 value</i>	Displays, in integer format, the data received from the first follower (ie. follower with node address 2) as word 1. Parameter <a href="#">62.04 Follower node 2 data 1 sel</a> can be used to select a target for the received data. This parameter can also be used as a signal source by other parameters.	0
	0...65535	Data received as word 1 from follower with node address 2.	
62.29	<i>Follower node 2 data 2 value</i>	Displays, in integer format, the data received from the first follower (ie. follower with node address 2) as word 2. Parameter <a href="#">62.05 Follower node 2 data 2 sel</a> can be used to select a target for the received data. This parameter can also be used as a signal source by other parameters.	0
	0...65535	Data received as word 2 from follower with node address 2.	
62.30	<i>Follower node 2 data 3 value</i>	Displays, in integer format, the data received from the first follower (ie. follower with node address 2) as word 3. Parameter <a href="#">62.06 Follower node 2 data 3 sel</a> can be used to select a target for the received data. This parameter can also be used as a signal source by other parameters.	0
	0...65535	Data received as word 3 from follower with node address 2.	
62.31	<i>Follower node 3 data 1 value</i>	Displays, in integer format, the data received from the second follower (ie. follower with node address 3) as word 1. Parameter <a href="#">62.07 Follower node 3 data 1 sel</a> can be used to select a target for the received data. This parameter can also be used as a signal source by other parameters.	0
	0...65535	Data received as word 1 from follower with node address 3.	
62.32	<i>Follower node 3 data 2 value</i>	Displays, in integer format, the data received from the second follower (ie. follower with node address 3) as word 2. Parameter <a href="#">62.08 Follower node 3 data 2 sel</a> can be used to select a target for the received data. This parameter can also be used as a signal source by other parameters.	0
	0...65535	Data received as word 2 from follower with node address 3.	
62.33	<i>Follower node 3 data 3 value</i>	Displays, in integer format, the data received from the second follower (ie. follower with node address 3) as word 3. Parameter <a href="#">62.09 Follower node 3 data 3 sel</a> can be used to select a target for the received data. This parameter can also be used as a signal source by other parameters.	0
	0...65535	Data received as word 3 from follower with node address 3.	
62.34	<i>Follower node 4 data 1 value</i>	Displays, in integer format, the data received from the third follower (ie. follower with node address 4) as word 1. Parameter <a href="#">62.10 Follower node 4 data 1 sel</a> can be used to select a target for the received data. This parameter can also be used as a signal source by other parameters.	0
	0...65535	Data received as word 1 from follower with node address 4.	

## 242 Parameters

No.	Name/Value	Description	Def/FbEq16
62.35	<i>Follower node 4 data 2 value</i>	Displays, in integer format, the data received from the third follower (ie. follower with node address 4) as word 2. Parameter <a href="#">62.11 Follower node 4 data 2 sel</a> can be used to select a target for the received data. This parameter can also be used as a signal source by other parameters.	0
	0...65535	Data received as word 2 from follower with node address 4.	
62.36	<i>Follower node 4 data 3 value</i>	Displays, in integer format, the data received from the third follower (ie. follower with node address 4) as word 3. Parameter <a href="#">62.12 Follower node 4 data 3 sel</a> can be used to select a target for the received data. This parameter can also be used as a signal source by other parameters.	0
	0...65535	Data received as word 3 from follower with node address 4.	
62.51	<i>Data set 10 data 1 selection</i>	Parameters <a href="#">62.51...62.74</a> define a target for the data received in datasets 10, 12, 14, 16, 18, 20, 22 and 24 from the external controller. Parameters <a href="#">62.101...62.124</a> display the data received from the external controller in integer format, and can be used as sources by other parameters. For example, this parameter selects a target for word 1 of dataset 10. Parameter <a href="#">62.101 Data set 10 data 1 value</a> displays the received data in integer format, and can also be used as a source by other parameters.	<i>None</i>
	None	None.	0
	CW 16bit	Control Word (16 bits)	1
	Ref1 16bit	Reference REF1 (16 bits)	2
	Ref2 16bit	Reference REF2 (16 bits)	3
	Other	The value is taken from another parameter.	-
62.52	<i>Data set 10 data 2 selection</i>	Defines a target for the data received as word 2 of dataset 10. See also parameter <a href="#">62.102 Data set 10 data 2 value</a> . For the selections, see parameter <a href="#">62.51 Data set 10 data 1 selection</a> .	<i>None</i>
62.53	<i>Data set 10 data 3 selection</i>	Defines a target for the data received as word 3 of dataset 10. See also parameter <a href="#">62.103 Data set 10 data 3 value</a> . For the selections, see parameter <a href="#">62.51 Data set 10 data 1 selection</a> .	<i>None</i>
62.54	<i>Data set 12 data 1 selection</i>	See parameter <a href="#">62.51 Data set 10 data 1 selection</a> .	<i>None</i>
...	...	...	...
62.74	<i>Data set 24 data 3 selection</i>	See parameter <a href="#">62.51 Data set 10 data 1 selection</a> .	<i>None</i>
62.101	<i>Data set 10 data 1 value</i>	Displays (in integer format) the data received from the external controller as word 1 of dataset 10. A target for this data can be selected by parameter <a href="#">62.51 Data set 10 data 1 selection</a> . The value can also be used as a source by another parameter.	0
	0...65535	Data received as word 1 of dataset 10.	

No.	Name/Value	Description	Def/FbEq16
62.102	<a href="#">Data set 10 data 2 value</a>	Displays (in integer format) the data received from the external controller as word 2 of dataset 10. A target for this data can be selected by parameter <a href="#">62.52 Data set 10 data 2 selection</a> . The value can also be used as a source by another parameter.	0
	0...65535	Data received as word 2 of dataset 10.	
62.103	<a href="#">Data set 10 data 3 value</a>	Displays (in integer format) the data received from the external controller as word 3 of dataset 10. A target for this data can be selected by parameter <a href="#">62.53 Data set 10 data 3 selection</a> . The value can also be used as a source by another parameter.	0
	0...65535	Data received as word 3 of dataset 10.	
62.104	<a href="#">Data set 12 data 1 value</a>	Displays (in integer format) the data received from the external controller as word 1 of dataset 12. A target for this data can be selected by parameter <a href="#">62.54 Data set 12 data 1 selection</a> . The value can also be used as a source by another parameter.	0
	0...65535	Data received as word 1 of dataset 12.	
...	...	...	...
62.124	<a href="#">Data set 24 data 3 value</a>	Displays (in integer format) the data received from the external controller as word 3 of dataset 24. A target for this data can be selected by parameter <a href="#">62.74 Data set 24 data 3 selection</a> . The value can also be used as a source by another parameter.	0
	0...65535	Data received as word 3 of dataset 24.	
<b>90 Feedback selection</b>		Motor speed feedback configuration. See also section <a href="#">Encoder support</a> (page 37), and the diagram on page 351.	
90.01	<a href="#">Motor speed for control</a>	Displays the estimated or measured motor speed that is used for motor control, ie. final motor speed feedback selected by parameter <a href="#">90.41 Motor feedback selection</a> and filtered by parameter <a href="#">90.42 Motor speed filter time</a> . This parameter is read-only.	-
	-21474836.48 ... 21474836.47 rpm	Motor speed used for control.	See par. <a href="#">46.01</a>
90.02	<a href="#">Motor position</a>	Displays the motor position received from the source selected by parameter <a href="#">90.41 Motor feedback selection</a> . This parameter is read-only.	-
	-21474836.48 ... 21474836.47 rev	Motor position.	-
90.03	<a href="#">Load speed</a>	Displays the estimated or measured load speed that is used for motor control, ie. final load speed feedback selected by parameter <a href="#">90.51 Load feedback selection</a> and filtered by parameter <a href="#">90.52 Load speed filter time</a> . This parameter is read-only.	-
	-21474836.48 ... 21474836.47 rpm	Load speed.	See par. <a href="#">46.01</a>

## 244 Parameters

No.	Name/Value	Description	Def/FbEq16
90.04	<i>Load position</i>	Displays the load position received from the source selected by parameter <a href="#">90.51 Load feedback selection</a> . This parameter is read-only.	-
	-2147483648 ... 2147483647 rev	Load position.	-
90.05	<i>Load position scaled</i>	Displays the load position scaled with feed constant (see parameters <a href="#">90.63 Feed constant numerator</a> and <a href="#">90.64 Feed constant denominator</a> ). This parameter is read-only.	-
	-2147483648 ... 2147483647	Scaled load position.	-
90.10	<i>Encoder 1 speed</i>	Displays encoder 1 speed in rpm. This parameter is read-only.	-
	-21474836.48 ... 21474836.47 rpm	Encoder 1 speed.	See par. <a href="#">46.01</a>
90.11	<i>Encoder 1 position</i>	Displays the actual position of encoder 1 within one revolution. This parameter is read-only.	-
	-21474836.48 ... 21474836.47 rev	Encoder 1 position within one revolution.	-
90.12	<i>Encoder 1 multiturn revolutions</i>	Displays the actual position of encoder 1 in full revolutions. This parameter is read-only.	-
	0 ... 4294967295	Encoder 1 position in revolutions.	-
90.13	<i>Encoder 1 revolution extension</i>	Displays the revolution counter extension for encoder 1. The counter is incremented when encoder position (parameter <a href="#">90.11</a> ) wraps around in the positive direction, and decremented in the negative direction. This parameter is effective only if position is absolute; updated for both single-turn and multiturn encoders. This parameter is read-only.	-
	-2147483648 ... 2147483647	Encoder 1 revolution counter extension.	-
90.14	<i>Encoder 1 position raw</i>	Displays encoder 1 position within one revolution as a 24-bit unsigned integer received from the encoder interface. This parameter is read-only.	-
	0.00 ... 65535.00	Raw encoder 1 position within one revolution.	-
90.15	<i>Encoder 1 revolutions raw</i>	Displays encoder 1 revolutions as a raw measurement. This parameter is read-only.	-
	0...65535	Raw encoder 1 revolution count.	-
90.20	<i>Encoder 2 speed</i>	Displays encoder 2 speed in rpm. This parameter is read-only.	-
	-21474836.48 ... 21474836.47 rpm	Encoder 2 speed.	See par. <a href="#">46.01</a>
90.21	<i>Encoder 2 position</i>	Displays the actual position of encoder 2 within one revolution. This parameter is read-only.	-
	-21474836.48 ... 21474836.47 rev	Encoder 2 position within one revolution.	-

No.	Name/Value	Description	Def/FbEq16
90.22	<a href="#">Encoder 2 multiturn revolutions</a>	Displays the actual position of encoder 2 in full revolutions. This parameter is read-only.	-
	0 ... 4294967295	Encoder 2 position in revolutions.	-
90.23	<a href="#">Encoder 2 revolution extension</a>	Displays the revolution counter extension for encoder 2. The counter is incremented when encoder position (parameter <a href="#">90.21</a> ) wraps around in the positive direction, and decremented in the negative direction. This parameter is effective only if position is absolute; updated for both single-turn and multiturn encoders. This parameter is read-only.	-
	-2147483648 ... 2147483647	Encoder 2 revolution counter extension.	-
90.24	<a href="#">Encoder 2 position raw</a>	Displays encoder 2 position within one revolution as a raw (24-bit unsigned integer) measurement. This parameter is read-only.	-
	0...65535	Raw encoder 2 position within one revolution.	-
90.25	<a href="#">Encoder 2 revolutions raw</a>	Displays encoder 2 revolutions as a raw measurement. This parameter is read-only.	-
	0...65535	Raw encoder 2 revolution count.	-
90.26	<a href="#">Motor revolution extension</a>	Displays the motor revolution counter extension. The counter is incremented when encoder position wraps around in the positive direction, and decremented in the negative direction. This parameter is effective only if position is absolute; updated for both single-turn and multiturn encoders. This parameter is read-only.	-
	-2147483648 ... 2147483647	Motor revolution counter extension.	-
90.27	<a href="#">Load revolution extension</a>	Displays the load revolution counter extension. The counter is incremented when encoder position wraps around in the positive direction, and decremented in the negative direction. This parameter is effective only if position is absolute; updated for both single-turn and multiturn encoders. This parameter is read-only.	-
	-2147483648 ... 2147483647	Load revolution counter extension.	-
90.41	<a href="#">Motor feedback selection</a>	Selects the motor speed feedback value used in control.	<i>Estimate</i>
	Estimate	A calculated speed estimate is used.	0
	Encoder 1	Actual speed measured by encoder 1. The encoder is set up by the parameters in group <a href="#">92 Encoder 1 configuration</a> .	1
	Encoder 2	Actual speed measured by encoder 2. The encoder is set up by the parameters in group <a href="#">93 Encoder 2 configuration</a> .	2
90.42	<a href="#">Motor speed filter time</a>	Defines a filter time for motor speed feedback used for control ( <a href="#">90.01 Motor speed for control</a> ).	3 ms
	0 ... 10000 ms	Motor speed filter time.	1 = 1 ms

No.	Name/Value	Description	Def/FbEq16
90.43	<i>Motor gear numerator</i>	Parameters <a href="#">90.43</a> and <a href="#">90.44</a> define a gear function between the motor speed feedback and motor control. The gear is used to correct a difference between the motor and encoder speeds for example if the encoder is not mounted directly on the motor shaft.  $\frac{\text{90.43 Motor gear numerator}}{\text{90.44 Motor gear denominator}} = \frac{\text{Motor speed}}{\text{Encoder speed}}$	1
	-2147483648 ... 2147483647	Motor gear numerator.	-
90.44	<i>Motor gear denominator</i>	See parameter <a href="#">90.43 Motor gear numerator</a> .	1
	-2147483648 ... 2147483647	Motor gear denominator.	-
90.45	<i>Motor feedback fault</i>	Selects how the drive reacts to loss of motor feedback.	<i>Fault</i>
	Fault	Drive trips on a <a href="#">7301 Motor speed feedback</a> fault.	0
	Warning	Drive generates a <a href="#">A7B0 Motor speed feedback</a> warning.	1
	None	No action taken.	2
90.46	<i>Force open loop</i>	Forces the use of estimated speed feedback.	<i>No</i>
	No	The feedback selected by <a href="#">90.41 Motor feedback selection</a> is used.	0
	Yes	Calculated speed estimate is used (regardless of setting of <a href="#">90.41 Motor feedback selection</a> ).	1
90.51	<i>Load feedback selection</i>	Selects the load speed feedback value used in control.	<i>None</i>
	None	No load feedback selected.	0
	Encoder 1	Actual speed measured by encoder 1. The encoder is set up by the parameters in group <a href="#">92 Encoder 1 configuration</a> .	1
	Encoder 2	Actual speed measured by encoder 2. The encoder is set up by the parameters in group <a href="#">93 Encoder 2 configuration</a> .	2
	Estimate	A calculated speed estimate is used.	3
	Motor feedback	The source selected by parameter <a href="#">90.41 Motor feedback selection</a> for motor feedback is also used for load feedback. Any difference between the motor and load speeds can be compensated by using the load gear function; see parameter <a href="#">90.53 Load gear numerator</a> .	4
90.52	<i>Load speed filter time</i>	Defines a filter time for load speed feedback ( <a href="#">90.03 Load speed</a> ).	4 ms
	0 ... 10000 ms	Load speed filter time.	-

No.	Name/Value	Description	Def/FbEq16
90.53	<i>Load gear numerator</i>	Parameters 90.53 and 90.54 define a gear function between the load (ie. driven equipment) speed feedback and motor control. The gear is used to correct a difference between the load and encoder speeds for example if the encoder is not mounted directly on the rotated machinery.  $\frac{90.53 \text{ Load gear numerator}}{90.54 \text{ Load gear denominator}} = \frac{\text{Load speed}}{\text{Encoder speed}}$	1
	-2147483648 ... 2147483647	Load gear numerator.	-
90.54	<i>Load gear denominator</i>	See parameter 90.53 <i>Load gear numerator</i> .	1
	-2147483648 ... 2147483647	Load gear denominator.	-
90.56	<i>Load position offset</i>	Load-side position offset. The resolution is determined by parameter 90.57 <i>Load position resolution</i> .	0 rev
	-32768 ... 32767 rev	Load-side position offset.	-
90.57	<i>Load position resolution</i>	Defines how many bits are used for load position count within one revolution.	16
	0...32	Load position resolution.	-
90.61	<i>Gear numerator</i>	Parameters 90.61 and 90.62 define a gear function between the motor and load speeds.  $\frac{90.61 \text{ Gear numerator}}{90.62 \text{ Gear denominator}} = \frac{\text{Motor speed}}{\text{Load speed}}$	1
	-2147483648 ... 2147483647	Gear numerator (motor-side).	-
90.62	<i>Gear denominator</i>	See parameter 90.61 <i>Gear numerator</i> .	1
	-2147483648 ... 2147483647	Gear denominator (load-side).	-
90.63	<i>Feed constant numerator</i>	Parameters 90.63 and 90.64 define the feed constant for the position calculation:  $\frac{90.63 \text{ Feed constant numerator}}{90.64 \text{ Feed constant denominator}}$  The feed constant converts rotational motion into translatory motion. The feed constant is the distance the load moves during one turn of the motor shaft. The translatory load position is shown by parameter 90.05 <i>Load position scaled</i> .	1
	-2147483648 ... 2147483647	Feed constant numerator.	-
90.64	<i>Feed constant denominator</i>	See parameter 90.63 <i>Feed constant numerator</i> .	1
	-2147483648 ... 2147483647	Feed constant denominator.	-

No.	Name/Value	Description	Def/FbEq16													
<b>91 Encoder module settings</b>		Configuration of encoder interface modules.														
<b>91.01</b>	<b>FEN DI status</b>	Displays the status of the digital inputs of FEN-xx encoder interface modules. This parameter is read-only.	-													
	<table border="1"> <thead> <tr> <th>Bit</th> <th>Name</th> </tr> </thead> <tbody> <tr> <td>0</td> <td>DI1 of interface 1 (see parameters <a href="#">91.11</a> and <a href="#">91.12</a>)</td> </tr> <tr> <td>1</td> <td>DI2 of interface 1 (see parameters <a href="#">91.11</a> and <a href="#">91.12</a>)</td> </tr> <tr> <td>2...3</td> <td>Reserved</td> </tr> <tr> <td>4</td> <td>DI1 of interface 2 (see parameters <a href="#">91.13</a> and <a href="#">91.14</a>)</td> </tr> <tr> <td>5</td> <td>DI2 of interface 2 (see parameters <a href="#">91.13</a> and <a href="#">91.14</a>)</td> </tr> <tr> <td>6...15</td> <td>Reserved</td> </tr> </tbody> </table>	Bit	Name	0	DI1 of interface 1 (see parameters <a href="#">91.11</a> and <a href="#">91.12</a> )	1	DI2 of interface 1 (see parameters <a href="#">91.11</a> and <a href="#">91.12</a> )	2...3	Reserved	4	DI1 of interface 2 (see parameters <a href="#">91.13</a> and <a href="#">91.14</a> )	5	DI2 of interface 2 (see parameters <a href="#">91.13</a> and <a href="#">91.14</a> )	6...15	Reserved	
Bit	Name															
0	DI1 of interface 1 (see parameters <a href="#">91.11</a> and <a href="#">91.12</a> )															
1	DI2 of interface 1 (see parameters <a href="#">91.11</a> and <a href="#">91.12</a> )															
2...3	Reserved															
4	DI1 of interface 2 (see parameters <a href="#">91.13</a> and <a href="#">91.14</a> )															
5	DI2 of interface 2 (see parameters <a href="#">91.13</a> and <a href="#">91.14</a> )															
6...15	Reserved															
	0000h...FFFFh	Status word of digital inputs on FEN-xx modules.	1 = 1													
<b>91.02</b>	<b>Module 1 status</b>	Displays the type of the interface module found in the location specified by parameter <a href="#">91.12 Module 1 location</a> . <b>0</b> = No module found; <b>1</b> = No communication; <b>2</b> = Unknown; <b>3</b> = FEN-01; <b>4</b> = FEN-11; <b>5</b> = FEN-21; <b>6</b> = FEN-31. This parameter is read-only.	-													
<b>91.03</b>	<b>Module 2 status</b>	Displays the type of the interface module found in the location specified by parameter <a href="#">91.14 Module 2 location</a> . <b>0</b> = No module found; <b>1</b> = No communication; <b>2</b> = Unknown; <b>3</b> = FEN-01; <b>4</b> = FEN-11; <b>5</b> = FEN-21; <b>6</b> = FEN-31. This parameter is read-only.	-													
<b>91.04</b>	<b>Module 1 temperature</b>	Displays the temperature measured through the sensor input of interface module 1. This parameter is read-only.	-													
	0...1000 °C	Temperature measured through interface module 1.	-													
<b>91.06</b>	<b>Module 2 temperature</b>	Displays the temperature measured through the sensor input of interface module 2. This parameter is read-only.	-													
	0...1000 °C	Temperature measured through interface module 2.	-													
<b>91.10</b>	<b>Encoder parameter refresh</b>	Forces a reconfiguration of the FEN-xx encoder interface modules, which is needed for any parameter changes in groups 90...93 to take effect. <b>Note:</b> The parameter cannot be changed while the drive is running.	<i>Done</i>													
	Done	Reconfiguration done (normal operation).	0													
	Configure	Reconfigure. The value reverts automatically to <i>Done</i> .	1													
<b>91.11</b>	<b>Module 1 type</b>	Defines the type of the module used as interface module 1.	<i>None</i>													
	None	None (communication disabled).	0													
	FEN-01	FEN-01.	1													
	FEN-11	FEN-11.	2													
	FEN-21	FEN-21.	3													
	FEN-31	FEN-31.	4													



No.	Name/Value	Description	Def/FbEq16
91.12	<i>Module 1 location</i>	Specifies the slot (1...3) on the control unit of the drive into which the interface module is installed.	1
	1...254	Slot number.	-
91.13	<i>Module 2 type</i>	Defines the type of the module used as interface module 2.	<i>None</i>
	None	None (communication disabled).	0
	FEN-01	FEN-01.	1
	FEN-11	FEN-11.	2
	FEN-21	FEN-21.	3
	FEN-31	FEN-31.	4
91.14	<i>Module 2 location</i>	Specifies the slot (1...3) on the control unit of the drive into which the interface module is installed.	1
	1...254	Slot number.	-
91.21	<i>Temperature meas sel1</i>	Specifies the type of temperature sensor connected to interface module 1.	<i>None</i>
	None	None.	0
	PTC	PTC.	1
	KTY-84	KTY84.	2
91.22	<i>Temperature filtering time 1</i>	Defines a filtering time for the temperature measurement through interface module 1.	1500 ms
	0...10000 ms	Filtering time for temperature measurement.	-
91.23	<i>PTC filtering 1</i>	Defines how many consecutive samples must be received by interface module 1 before the status of a PTC sensor is interpreted as true instead of false.	1
	0...65535	Number of samples.	-
91.24	<i>Temperature meas sel2</i>	Specifies the type of temperature sensor connected to interface module 2.	<i>None</i>
	None	None.	0
	PTC	PTC.	1
	KTY-84	KTY84.	2
91.25	<i>Temperature filtering time 2</i>	Defines a filtering time for the temperature measurement through interface 2.	1500 ms
	0...10000 ms	Filtering time for temperature measurement.	-
91.26	<i>PTC filtering 2</i>	Defines how many consecutive samples must be received by interface module 2 before the status of a PTC sensor is interpreted as true instead of false.	1
	0...65535	Number of samples.	-

No.	Name/Value	Description	Def/FbEq16
	<b>92 Encoder 1 configuration</b>	Settings for encoder 1. <b>Notes:</b> <ul style="list-style-type: none"> <li>The contents of the parameter group vary according to the selected encoder type.</li> <li>It is recommended that encoder connection 1 (this group) is used whenever possible since the data received through that interface is fresher than the data received through connection 2 (group <a href="#">93 Encoder 2 configuration</a>).</li> </ul>	
<a href="#">92.01</a>	<a href="#">Encoder 1 type</a>	Activates the communication with optional encoder/resolver interface module 1.	<i>None</i>
	None	Inactive.	0
	TTL	Communication active. Module type: FEN-01 TTL Encoder Interface. Input: TTL encoder input (X31).	1
	TTL+	Communication active. Module type: FEN-01 TTL Encoder interface. Input: TTL encoder input with commutation support (X32).	2
	Abs enc	Communication active. Module type: FEN-11 Absolute Encoder Interface. Input: Absolute encoder input (X42).	3
	Resolver	Communication active. Module type: FEN-21 Resolver Interface. Input: Resolver input (X52).	4
	HTL	Communication active. Module type: FEN-31 HTL Encoder Interface. Input: HTL encoder input (X82).	5
<a href="#">92.02</a>	<a href="#">Encoder 1 source</a>	Selects the interface module that the encoder is connected to. (The physical locations and types of encoder interface modules are defined in parameter group <a href="#">91 Encoder module settings</a> .)	<i>Module 1</i>
	Module 1	Interface module 1.	1
	Module 2	Interface module 2.	2
<a href="#">92.03</a>	<a href="#">Encoder 1 type act</a>	Displays the type of optional encoder/resolver interface 1. For the possible values, see parameter <a href="#">92.01 Encoder 1 type</a> . This parameter is read-only.	-
<a href="#">92.10</a>	<a href="#">Pulses/revolution</a>	(Visible when <a href="#">92.01 Encoder 1 type</a> = <i>TTL</i> , <i>TTL+</i> or <i>HTL</i> ) Defines the pulse number per revolution.	0
	0...65535	Number of pulses.	-
<a href="#">92.10</a>	<a href="#">Sine/cosine number</a>	(Visible when <a href="#">92.01 Encoder 1 type</a> = <i>Abs enc</i> ) Defines the number of sine/cosine wave cycles within one revolution. <b>Note:</b> This parameter need not be set when an EnDat or SSI encoder is used in continuous mode. See parameter <a href="#">92.30 Serial link mode</a> .	0
	0...65535	Number of sine/cosine wave cycles within one revolution.	-
<a href="#">92.10</a>	<a href="#">Excitation signal frequency</a>	(Visible when <a href="#">92.01 Encoder 1 type</a> = <i>Resolver</i> ) Defines the frequency of the excitation signal.	1 kHz
	1...20 kHz	Excitation signal frequency.	1 = 1 kHz
<a href="#">92.11</a>	<a href="#">Pulse encoder type</a>	(Visible when <a href="#">92.01 Encoder 1 type</a> = <i>TTL</i> , <i>TTL+</i> or <i>HTL</i> ) Selects the type of encoder.	<i>Quadrature</i>
	Quadrature	Quadrature encoder (has two channels, A and B)	0
	Single track	Single-track encoder (has one channel, A)	1

No.	Name/Value	Description	Def/FbEq16								
92.11	<i>Absolute position source</i>	(Visible when 92.01 Encoder 1 type = Abs enc) Selects the source of the absolute position information.	None								
	None	Not selected.	0								
	Commut sig	Commutation signals.	1								
	EnDat	Serial interface: EnDat encoder.	2								
	Hiperface	Serial interface: HIPERFACE encoder.	3								
	SSI	Serial interface: SSI encoder.	4								
	Tamagawa	Serial interface: Tamagawa 17/33-bit encoder.	5								
92.11	<i>Excitation signal amplitude</i>	(Visible when 92.01 Encoder 1 type = Resolver) Defines the amplitude of the excitation signal.	4.0 V								
	4.0 ... 12.0 V	Excitation signal amplitude.	10 = 1 V								
92.12	<i>Speed calculation mode</i>	(Visible when 92.01 Encoder 1 type = TTL, TTL+ or HTL) Selects the speed calculation mode. *With a single-track encoder (parameter 92.11 Pulse encoder type is set to <i>Single track</i> ), the speed is always positive.	Auto rising								
	A&B all	Channels A and B: Rising and falling edges are used for speed calculation. *Channel B: Defines the direction of rotation. <b>Note:</b> With a single-track encoder (parameter 92.11 Pulse encoder type), this setting acts like setting <i>A all</i> .	0								
	A all	Channel A: Rising and falling edges are used for speed calculation. *Channel B: Defines the direction of rotation.	1								
	A rising	Channel A: Rising edges are used for speed calculation. *Channel B: Defines the direction of rotation.	2								
	A falling	Channel A: Falling edges are used for speed calculation. *Channel B: Defines the direction of rotation.	3								
	Auto rising	One of the above modes is selected automatically depending on the pulse frequency as follows:	4								
		<table border="1"> <thead> <tr> <th>Pulse frequency of the channel(s)</th> <th>Used mode</th> </tr> </thead> <tbody> <tr> <td>&lt; 2442 Hz</td> <td><i>A&amp;B all</i></td> </tr> <tr> <td>2442...4884 Hz</td> <td><i>A all</i></td> </tr> <tr> <td>&gt; 4884 Hz</td> <td><i>A rising</i></td> </tr> </tbody> </table>	Pulse frequency of the channel(s)	Used mode	< 2442 Hz	<i>A&amp;B all</i>	2442...4884 Hz	<i>A all</i>	> 4884 Hz	<i>A rising</i>	
Pulse frequency of the channel(s)	Used mode										
< 2442 Hz	<i>A&amp;B all</i>										
2442...4884 Hz	<i>A all</i>										
> 4884 Hz	<i>A rising</i>										
	Auto falling	One of the above modes is selected automatically depending on the pulse frequency as follows:	5								
		<table border="1"> <thead> <tr> <th>Pulse frequency of the channel(s)</th> <th>Used mode</th> </tr> </thead> <tbody> <tr> <td>&lt; 2442 Hz</td> <td><i>A&amp;B all</i></td> </tr> <tr> <td>2442...4884 Hz</td> <td><i>A all</i></td> </tr> <tr> <td>&gt; 4884 Hz</td> <td><i>A falling</i></td> </tr> </tbody> </table>	Pulse frequency of the channel(s)	Used mode	< 2442 Hz	<i>A&amp;B all</i>	2442...4884 Hz	<i>A all</i>	> 4884 Hz	<i>A falling</i>	
Pulse frequency of the channel(s)	Used mode										
< 2442 Hz	<i>A&amp;B all</i>										
2442...4884 Hz	<i>A all</i>										
> 4884 Hz	<i>A falling</i>										
92.12	<i>Zero pulse enable</i>	(Visible when 92.01 Encoder 1 type = Abs enc) Enables the encoder zero pulse for the absolute encoder input (X42) of the FEN-11 interface module. <b>Note:</b> No zero pulse exists with serial interfaces, ie. when parameter 92.11 Absolute position source is set to <i>EnDat</i> , <i>Hiperface</i> , <i>SSI</i> or <i>Tamagawa</i> .	Disable								
	Disable	Zero pulse disabled.	0								

## 252 Parameters

No.	Name/Value	Description	Def/FbEq16
	Enable	Zero pulse enabled.	1
92.12	<i>Resolver polepairs</i>	<i>(Visible when 92.01 Encoder 1 type = Resolver)</i> Defines the number of pole pairs of the encoder.	1
	1...32	Number of encoder pole pairs.	1 = 1
92.13	<i>Position estimation enable</i>	<i>(Visible when 92.01 Encoder 1 type = TTL, TTL+ or HTL)</i> Selects whether position estimation is used with encoder 1 to increase position data resolution or not.	<i>Enable</i>
	Disable	Measured position used. (The resolution is 4 × pulses per revolution for quadrature encoders, 2 × pulses per revolution for single-track encoders.)	0
	Enable	Estimated position used. (Uses position interpolation; extrapolated at the time of data request.)	1
92.13	<i>Position data width</i>	<i>(Visible when 92.01 Encoder 1 type = Abs enc)</i> Defines the number of bits used to indicate position within one revolution. For example, a setting of 15 bits corresponds to 32768 positions per revolution. The value is used when parameter <i>92.11 Absolute position source</i> is set to <i>EnDat</i> , <i>Hiperface</i> or <i>SSI</i> . When parameter <i>92.11 Absolute position source</i> is set to <i>Tamagawa</i> , this parameter is internally set to 17.	0
	0...32	Number of bits used in position indication within one revolution.	1 = 1
92.14	<i>Speed estimation enable</i>	<i>(Visible when 92.01 Encoder 1 type = TTL, TTL+ or HTL)</i> Selects whether calculated or estimated speed is used. Estimation increases the speed ripple in steady state operation, but improves the dynamics.	<i>Disable</i>
	Disable	Last calculated speed used. (The calculation interval is 62.5 microseconds to 4 milliseconds.)	0
	Enable	Estimated speed (estimated at the time of data request) is used.	1
92.14	<i>Revolution data width</i>	<i>(Visible when 92.01 Encoder 1 type = Abs enc)</i> Defines the number of bits used in revolution counting with an multiturn encoder. For example, a setting of 12 bits would support counting up to 4096 revolutions. The value is used when parameter <i>92.11 Absolute position source</i> is set to <i>EnDat</i> , <i>Hiperface</i> or <i>SSI</i> . When parameter <i>92.11 Absolute position source</i> is set to <i>Tamagawa</i> , setting this parameter to a non-zero value activates multiturn data requesting.	0
	0...32	Number of bits used in revolution count.	1 = 1
92.15	<i>Transient filter</i>	<i>(Visible when 92.01 Encoder 1 type = TTL, TTL+ or HTL)</i> Activates transient filtering for the encoder (changes in direction of rotation are ignored above the selected pulse frequency).	<i>4880 Hz</i>
	4880 Hz	Change in direction of rotation allowed below 4880 Hz.	0
	2440 Hz	Change in direction of rotation allowed below 2440 Hz.	1
	1220 Hz	Change in direction of rotation allowed below 1220 Hz.	2
	Disabled	Change in direction of rotation allowed at any pulse frequency.	3

No.	Name/Value	Description	Def/FbEq16
92.20	<i>Encoder cable fault func</i>	(Visible when 92.01 Encoder 1 type = TTL, TTL+ or HTL) Selects the action taken by the drive in case an encoder wiring fault is detected by the FEN-31 encoder interface.	<i>Fault</i>
	No	Wiring fault monitoring disabled.	0
	Warning	The drive generates a warning ( <i>A7E1 Encoder 1</i> ).	1
	Fault	The drive trips on <i>7381 Encoder 1</i> .	2
92.21	<i>Encoder cable fault mode</i>	(Visible when 92.01 Encoder 1 type = TTL, TTL+ or HTL) Selects which encoder cable channels and wires are monitored for wiring faults. See also parameter 92.20 <i>Encoder cable fault func</i> .	<i>A, B</i>
	A, B	A and B.	0
	A, B, Z	A, B and Z.	1
	A+, A-, B+, B-	A+, A-, B+ and B-.	2
	A+, A-, B+, B-, Z+, Z-	A+, A-, B+, B-, Z+ and Z-.	3
92.30	<i>Serial link mode</i>	(Visible when 92.01 Encoder 1 type = Abs enc) Selects the serial link mode with an EnDat or SSI encoder.	<i>Initial pos.</i>
	Initial pos.	Single position transfer mode (initial position).	0
	Continuous	Continuous position data transfer mode.	1
92.31	<i>EnDat max calculation time</i>	(Visible when 92.01 Encoder 1 type = Abs enc) Selects the maximum encoder calculation time for an EnDat encoder. <b>Note:</b> This parameter needs to be set only when an EnDat encoder is used in continuous mode, ie. without incremental sin/cos signals (supported only as encoder 1). See also parameter 92.30 <i>Serial link mode</i> .	<i>50 ms</i>
	10 us	10 microseconds.	0
	100 us	100 microseconds.	1
	1 ms	1 millisecond.	2
	50 ms	50 milliseconds.	3
92.32	<i>SSI cycle time</i>	(Visible when 92.01 Encoder 1 type = Abs enc) Selects the transmission cycle for an SSI encoder. <b>Note:</b> This parameter needs to be set only when an SSI encoder is used in continuous mode, ie. without incremental sin/cos signals (supported only as encoder 1). See also parameter 92.30 <i>Serial link mode</i> .	<i>100 us</i>
	50 us	50 microseconds.	0
	100 us	100 microseconds.	1
	200 us	200 microseconds.	2
	500 us	500 microseconds.	3
	1 ms	1 millisecond.	4
	2 ms	2 milliseconds.	5
92.33	<i>SSI clock cycles</i>	(Visible when 92.01 Encoder 1 type = Abs enc) Defines the length of an SSI message. The length is defined as the number of clock cycles. The number of cycles can be calculated by adding 1 to the number of bits in an SSI message frame.	2
	2...127	SSI message length.	-

## 254 Parameters

No.	Name/Value	Description	Def/FbEq16
92.34	<i>SSI position msb</i>	<i>(Visible when 92.01 Encoder 1 type = Abs enc)</i> With an SSI encoder, defines the location of the MSB (most significant bit) of the position data within an SSI message.	1
	1...126	Position data MSB location (bit number).	-
92.35	<i>SSI revolution msb</i>	<i>(Visible when 92.01 Encoder 1 type = Abs enc)</i> With an SSI encoder, defines the location of the MSB (most significant bit) of the revolution count within an SSI message.	1
	1...126	Revolution count MSB location (bit number).	-
92.36	<i>SSI data format</i>	<i>(Visible when 92.01 Encoder 1 type = Abs enc)</i> Selects the data format for an SSI encoder.	<i>binary</i>
	binary	Binary code.	0
	gray	Gray code.	1
92.37	<i>SSI baud rate</i>	<i>(Visible when 92.01 Encoder 1 type = Abs enc)</i> Selects the baud rate for an SSI encoder.	<i>100 kBit/s</i>
	10 kBit/s	10 kbit/s.	0
	50 kBit/s	50 kbit/s.	1
	100 kBit/s	100 kbit/s.	2
	200 kBit/s	200 kbit/s.	3
	500 kBit/s	500 kbit/s.	4
	1000 kBit/s	1000 kbit/s.	5
92.40	<i>SSI zero phase</i>	<i>(Visible when 92.01 Encoder 1 type = Abs enc)</i> Defines the phase angle within one sine/cosine signal period that corresponds to the value of zero on the SSI serial link data. The parameter is used to adjust the synchronization of the SSI position data and the position based on sine/cosine incremental signals. Incorrect synchronization may cause an error of $\pm 1$ incremental period. <b>Note:</b> This parameter needs to be set only when an SSI encoder is used in initial position mode (see parameter <a href="#">92.30 Serial link mode</a> ).	<i>315-45 deg</i>
	315-45 deg	315-45 degrees.	0
	45-135 deg	45-135 degrees.	1
	135-225 deg	135-225 degrees.	2
	225-315 deg	225-315 degrees.	3
92.45	<i>Hiperface parity</i>	<i>(Visible when 92.01 Encoder 1 type = Abs enc)</i> Defines the use of parity and stop bits with a HIPERFACE encoder. Typically this parameter need not be set.	<i>Odd</i>
	Odd	Odd parity indication bit, one stop bit.	0
	Even	Even parity indication bit, one stop bit.	1
92.46	<i>Hiperface baud rate</i>	<i>(Visible when 92.01 Encoder 1 type = Abs enc)</i> Defines the transfer rate of the link with a HIPERFACE encoder. Typically this parameter need not be set.	<i>4800 bits/s</i>
	4800 bits/s	4800 bit/s.	0
	9600 bits/s	9600 bit/s.	1
	19200 bits/s	19200 bit/s.	2

No.	Name/Value	Description	Def/FbEq16
	38400 bits/s	38400 bit/s.	3
92.47	<i>Hiperface node address</i>	(Visible when 92.01 Encoder 1 type = Abs enc) Defines the node address for a HIPERFACE encoder. Typically this parameter need not be set.	64
	0...255	HIPERFACE encoder node address.	-
<b>93 Encoder 2 configuration</b>		Settings for encoder 2. <b>Notes:</b> <ul style="list-style-type: none"> <li>The contents of the parameter group vary according to the selected encoder type.</li> <li>It is recommended that encoder connection 1 (group 92 Encoder 1 configuration) is used whenever possible since the data received through that interface is fresher than the data received through connection 2 (this group).</li> </ul>	
93.01	<i>Encoder 2 type</i>	Activates the communication with optional encoder/resolver interface module 2.	None
	None	Inactive.	0
	TTL	Communication active. Module type: FEN-01 TTL Encoder Interface. Input: TTL encoder input (X31).	1
	TTL+	Communication active. Module type: FEN-01 TTL Encoder interface. Input: TTL encoder input with commutation support (X32).	2
	Abs enc	Communication active. Module type: FEN-11 Absolute Encoder Interface. Input: Absolute encoder input (X42).	3
	Resolver	Communication active. Module type: FEN-21 Resolver Interface. Input: Resolver input (X52).	4
	HTL	Communication active. Module type: FEN-31 HTL Encoder Interface. Input: HTL encoder input (X82).	5
93.02	<i>Encoder 2 source</i>	Selects the interface module that the encoder is connected to. (The physical locations and types of encoder interface modules are defined in parameter group 91 Encoder module settings.)	Module 1
	Module 1	Interface module 1.	1
	Module 2	Interface module 2.	2
93.03	<i>Encoder 2 type act</i>	Displays the type of optional encoder/resolver interface module 1. For the possible values, see parameter 93.01 Encoder 2 type. This parameter is read-only.	-
93.10	<i>Pulses/revolution</i>	(Visible when 93.01 Encoder 2 type = TTL, TTL+ or HTL) See parameter 92.10 Pulses/revolution.	0
93.10	<i>Sine/cosine number</i>	(Visible when 93.01 Encoder 2 type = Abs enc) See parameter 92.10 Sine/cosine number.	0
93.10	<i>Excitation signal frequency</i>	(Visible when 93.01 Encoder 2 type = Resolver) See parameter 92.10 Excitation signal frequency.	1 kHz
93.11	<i>Pulse encoder type</i>	(Visible when 93.01 Encoder 2 type = TTL, TTL+ or HTL) See parameter 92.11 Pulse encoder type.	Quadrature
93.11	<i>Absolute position source</i>	(Visible when 93.01 Encoder 2 type = Abs enc) See parameter 92.11 Absolute position source.	None
93.11	<i>Excitation signal amplitude</i>	(Visible when 93.01 Encoder 2 type = Resolver) See parameter 92.11 Excitation signal amplitude.	4.0 V

No.	Name/Value	Description	Def/FbEq16
93.12	<i>Speed calculation mode</i>	(Visible when 93.01 Encoder 2 type = TTL, TTL+ or HTL) See parameter 92.12 <i>Speed calculation mode</i> .	<i>Auto rising</i>
93.12	<i>Zero pulse enable</i>	(Visible when 93.01 Encoder 2 type = Abs enc) See parameter 92.12 <i>Zero pulse enable</i> .	<i>Disable</i>
93.12	<i>Resolver polepairs</i>	(Visible when 93.01 Encoder 2 type = Resolver) See parameter 92.12 <i>Resolver polepairs</i> .	1
93.13	<i>Position estimation enable</i>	(Visible when 93.01 Encoder 2 type = TTL, TTL+ or HTL) See parameter 92.13 <i>Position estimation enable</i> .	<i>Enable</i>
93.13	<i>Position data width</i>	(Visible when 93.01 Encoder 2 type = Abs enc) See parameter 92.13 <i>Position data width</i> .	0
93.14	<i>Speed estimation enable</i>	(Visible when 93.01 Encoder 2 type = TTL, TTL+ or HTL) See parameter 92.14 <i>Speed estimation enable</i> .	<i>Disable</i>
93.14	<i>Revolution data width</i>	(Visible when 93.01 Encoder 2 type = Abs enc) See parameter 92.14 <i>Revolution data width</i> .	0
93.15	<i>Transient filter</i>	(Visible when 93.01 Encoder 2 type = TTL, TTL+ or HTL) See parameter 92.15 <i>Transient filter</i> .	<i>4880 Hz</i>
93.20	<i>Encoder cable fault func</i>	(Visible when 93.01 Encoder 2 type = TTL, TTL+ or HTL) See parameter 92.20 <i>Encoder cable fault func</i> .	<i>Fault</i>
93.21	<i>Encoder cable fault mode</i>	(Visible when 93.01 Encoder 2 type = TTL, TTL+ or HTL) See parameter 92.21 <i>Encoder cable fault mode</i> .	<i>A, B</i>
93.30	<i>Serial link mode</i>	(Visible when 93.01 Encoder 2 type = Abs enc) See parameter 92.30 <i>Serial link mode</i> .	<i>Initial pos.</i>
93.31	<i>EnDat calc time</i>	(Visible when 93.01 Encoder 2 type = Abs enc) See parameter 92.31 <i>EnDat max calculation time</i> .	<i>50 ms</i>
93.32	<i>SSI cycle time</i>	(Visible when 93.01 Encoder 2 type = Abs enc) See parameter 92.32 <i>SSI cycle time</i> .	<i>100 us</i>
93.33	<i>SSI clock cycles</i>	(Visible when 93.01 Encoder 2 type = Abs enc) See parameter 92.33 <i>SSI clock cycles</i> .	2
93.34	<i>SSI position msb</i>	(Visible when 93.01 Encoder 2 type = Abs enc) See parameter 92.34 <i>SSI position msb</i> .	1
93.35	<i>SSI revolution msb</i>	(Visible when 93.01 Encoder 2 type = Abs enc) See parameter 92.35 <i>SSI revolution msb</i> .	1
93.36	<i>SSI data format</i>	(Visible when 93.01 Encoder 2 type = Abs enc) See parameter 92.36 <i>SSI data format</i> .	<i>binary</i>
93.37	<i>SSI baud rate</i>	(Visible when 93.01 Encoder 2 type = Abs enc) See parameter 92.37 <i>SSI baud rate</i> .	<i>100 kBit/s</i>
93.40	<i>SSI zero phase</i>	(Visible when 93.01 Encoder 2 type = Abs enc) See parameter 92.40 <i>SSI zero phase</i> .	<i>315-45 deg</i>
93.45	<i>Hiperface parity</i>	(Visible when 93.01 Encoder 2 type = Abs enc) See parameter 92.45 <i>Hiperface parity</i> .	<i>Odd</i>
93.46	<i>Hiperface baud rate</i>	(Visible when 93.01 Encoder 2 type = Abs enc) See parameter 92.46 <i>Hiperface baud rate</i> .	<i>4800 bits/s</i>
93.47	<i>Hiperface node address</i>	(Visible when 93.01 Encoder 2 type = Abs enc) See parameter 92.47 <i>Hiperface node address</i> .	64

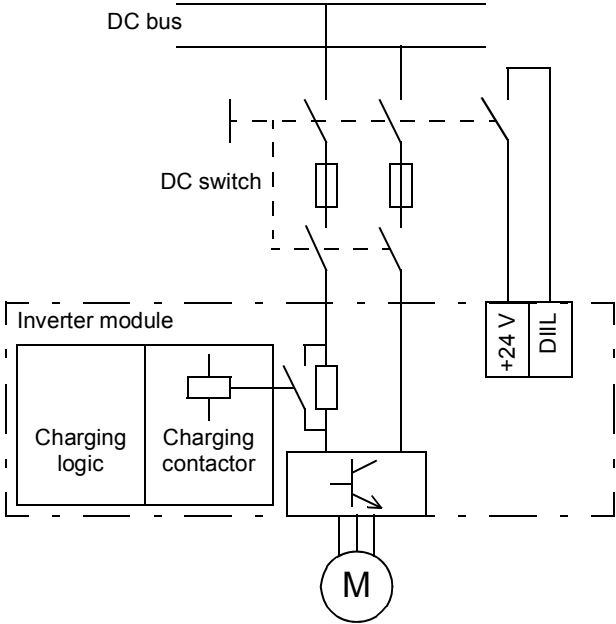

No.	Name/Value	Description	Def/FbEq16
<b>95 HW configuration</b>		Various hardware-related settings.	
<b>95.01</b>	<b>Supply voltage</b>	<p>Selects the supply voltage range. This parameter is used by the drive to determine the nominal voltage of the supply network. The parameter also affects the current ratings and the DC voltage control functions (trip and brake chopper activation limits) of the drive.</p> <p> <b>WARNING!</b> An incorrect setting may cause the motor to rush uncontrollably, or the overloading of the brake chopper or resistor.</p>	<i>Not given</i>
	Not given	No voltage defined. The drive will not start modulating before another value is selected.	0
	208...240 V	208...240 V	1
	380...415 V	380...415 V	2
	440...480 V	440...480 V	3
	500 V	500 V	4
	525...600 V	525...600 V	5
	660...690 V	660...690 V	6
<b>95.02</b>	<b>Adaptive voltage limits</b>	<p>Enables adaptive voltage limits.</p> <p>Adaptive voltage limits can be used if, for example, an IGBT supply unit is used to raise the DC voltage level. If the communication between the inverter and IGBT supply unit is active, the voltage limits are fixed to the DC voltage reference from the IGBT supply unit. Otherwise the limits are calculated based on the measured DC voltage at the end of the pre-charging sequence.</p>	<i>Disable</i>
	Disable	Adaptive voltage limits disabled.	0
	Enable	Adaptive voltage limits enabled.	1
<b>95.04</b>	<b>Control board supply</b>	Specifies how the control unit of the drive is powered.	<i>Internal 24V</i>
	Internal 24V	The drive control unit is powered from the drive power unit it is connected to. This is the default setting.	0
	External 24V	The drive control unit is powered from an external power supply.	1

No.	Name/Value	Description	Def/FbEq16
95.08	<i>Forced charging enable</i>	<p>Enables/disables DC switch monitoring via the DIIL input. This setting is intended for use with inverter modules with an internal charging circuit that are connected to the DC bus through a DC switch.</p> <p>An auxiliary contact of the DC switch must be wired to the DIIL input so that the input switches off when the DC switch is opened.</p>  <p>If the DC switch is opened with the inverter running, the inverter is given a coast-to-stop command, and its charging circuit activated.</p> <p>Starting the inverter is prevented until the DC switch is closed and the DC circuit in the inverter unit recharged.</p> <p><b>Note:</b> An internal charging circuit is standard on some inverter module types but optional on others; check with your local ABB representative.</p>	<i>Disable</i>
	Disable	DC switch monitoring through the DIIL input disabled.	0
	Enable	DC switch monitoring through the DIIL input enabled.	1
95.09	<i>Fuse switch control</i>	<p>Activates communication to a BSFC-xx switch fuse controller. This setting is intended for use with inverter modules that are connected to a DC bus through a DC switch/charging circuit controlled by a BSFC-xx switch fuse controller.</p> <p>The BSFC controls and monitors the charging of the inverter unit, and sends an enable command when the charging has finished. When the DC switch is opened, the BSFC stops the inverter.</p> <p>For more information, see BSFC documentation.</p>	<i>Disable</i>
	Disable	Communication with BSFC disabled.	0
	Enable	Communication with BSFC enabled.	1

No.	Name/Value	Description	Def/FbEq16
<b>96 System</b>		Language selection; parameter save and restore; user parameter sets; control unit reboot.	
<b>96.01</b>	<b>Language</b>	Selects the language of the parameter interface and other displayed information when viewed on the control panel. <b>Notes:</b> <ul style="list-style-type: none"> <li>• Not all languages listed below are necessarily supported.</li> <li>• This parameter does not affect the languages visible in the Drive composer PC tool. (Those are specified under View – Settings.)</li> </ul>	-
	Not selected	None.	0
	English US	US English.	1033
	Deutsch	German.	1031
	Italiano	Italian.	1040
	Español	Spanish.	3082
	Portugues	Portuguese.	2070
	Nederlands	Dutch.	1043
	Français	French.	1036
	Dansk	Danish.	1030
	Suomi	Finnish.	1035
	Svenska	Swedish.	1053
	Russki	Russian.	1049
	Chinese (Simplified, PRC)	Simplified Chinese.	2052
	Türkçe	Turkish.	1055
<b>96.02</b>	<b>Pass code</b>	Reserved.	0
	0...99999999	Pass code.	-
<b>96.04</b>	<b>Macro select</b>	Selects the application macro. See chapter <a href="#">Application macros</a> (page 65) for more information. After a selection is made, the parameter reverts automatically to <a href="#">Done</a> .	<a href="#">Done</a>
	Done	Macro selection complete; normal operation.	0
	Factory	Factory macro (see page 66).	1
	Hand/Auto	Hand/Auto macro (see page 68).	2
	PID-CTRL	PID control macro (see page 70).	3
	T-CTRL	Torque control macro (see page 74).	4
	Sequence control	Sequential control macro (see page 76).	5
	FIELDBUS	Reserved.	6
<b>96.05</b>	<b>Macro active</b>	Shows which application macro is currently selected. See chapter <a href="#">Application macros</a> (page 65) for more information. To change the macro, use parameter <a href="#">96.04 Macro select</a> .	<a href="#">Factory</a>
	Factory	Factory macro (see page 66).	1
	Hand/Auto	Hand/Auto macro (see page 68).	2
	PID-CTRL	PID control macro (see page 70).	3
	T-CTRL	Torque control macro (see page 74).	4

No.	Name/Value	Description	Def/FbEq16
	Sequence control	Sequential control macro (see page 76).	5
	FIELDBUS	Fieldbus control macro (see page 79).	6
96.06	<i>Parameter restore</i>	Restores the original settings of the control program, ie. parameter default values. <b>Note:</b> This parameter cannot be changed while the drive is running.	<i>Done</i>
	Done	Restoring is completed.	0
	Restore defaults	All editable parameter values are restored to default values, except <ul style="list-style-type: none"> <li>• motor data and ID run results</li> <li>• control panel/PC communication settings</li> <li>• I/O extension module settings</li> <li>• fieldbus adapter settings</li> <li>• encoder configuration data.</li> </ul>	8
	Clear all	All editable parameter values are restored to default values, except <ul style="list-style-type: none"> <li>• control panel/PC communication settings</li> <li>• fieldbus adapter settings</li> <li>• encoder configuration data.</li> </ul> PC tool communication is interrupted during the restoring.	62
96.07	<i>Parameter save</i>	Saves the valid parameter values to permanent memory. <b>Note:</b> A new parameter value is saved automatically when changed from the PC tool or panel but not when altered through a fieldbus adapter connection.	<i>Done</i>
	Done	Save completed.	0
	Save	Save in progress.	1
96.08	<i>Control board boot</i>	Changing the value of this parameter to 1 reboots the control unit. The value reverts to 0 automatically.	0
	0...4294967295	1 = Reboot control unit.	1 = 1
96.10	<i>User set status</i>	Shows the status of the user parameter sets. This parameter is read-only. See also section <i>User parameter sets</i> (page 64).	-
	n/a	No user parameter sets have been saved.	0
	Loading	A user set is being loaded.	1
	Saving	A user set is being saved.	2
	Faulted	Invalid or empty parameter set.	3
	User1 IO active	User set 1 has been selected by parameters <i>96.12 User set IO sel in1</i> and <i>96.13 User set IO sel in2</i> .	4
	User2 IO active	User set 2 has been selected by parameters <i>96.12 User set IO sel in1</i> and <i>96.13 User set IO sel in2</i> .	5
	User3 IO active	User set 3 has been selected by parameters <i>96.12 User set IO sel in1</i> and <i>96.13 User set IO sel in2</i> .	6
	User4 IO active	User set 4 has been selected by parameters <i>96.12 User set IO sel in1</i> and <i>96.13 User set IO sel in2</i> .	7
	User1 backup	User set 1 has been saved or loaded.	8
	User2 backup	User set 2 has been saved or loaded.	9
	User3 backup	User set 3 has been saved or loaded.	10
	User4 backup	User set 4 has been saved or loaded.	11

No.	Name/Value	Description	Def/FbEq16															
96.11	<i>User set save/load</i>	<p>Enables the saving and restoring of up to four custom sets of parameter settings.</p> <p>The set that was in use before powering down the drive is in use after the next power-up.</p> <p><b>Notes:</b></p> <ul style="list-style-type: none"> <li>Some hardware configuration settings, such as I/O extension module, fieldbus adapter and encoder configuration parameters (groups 14...16, 50...56 and 90...93 respectively) are not part of the user parameter sets.</li> <li>Parameter changes made after loading a set are not automatically stored – they must be saved using this parameter.</li> </ul>																
	No action	Load or save operation complete; normal operation.	0															
	IO mode	Load user parameter set using parameters <a href="#">96.12 User set IO sel in1</a> and <a href="#">96.13 User set IO sel in2</a> .	1															
	Load set 1	Load user parameter set 1.	2															
	Load set 2	Load user parameter set 2.	3															
	Load set 3	Load user parameter set 3.	4															
	Load set 4	Load user parameter set 4.	5															
	Save to set 1	Save user parameter set 1.	18															
	Save to set 2	Save user parameter set 2.	19															
	Save to set 3	Save user parameter set 3.	20															
	Save to set 4	Save user parameter set 4.	21															
96.12	<i>User set IO sel in1</i>	<p>When parameter <a href="#">96.11 User set save/load</a> is set to <i>IO mode</i>, selects the user parameter set together with parameter <a href="#">96.13 User set IO sel in2</a> as follows:</p> <table border="1"> <thead> <tr> <th>Status of source defined by par. <a href="#">96.12</a></th> <th>Status of source defined by par. <a href="#">96.13</a></th> <th>User parameter set selected</th> </tr> </thead> <tbody> <tr> <td>0</td> <td>0</td> <td>Set 1</td> </tr> <tr> <td>1</td> <td>0</td> <td>Set 2</td> </tr> <tr> <td>0</td> <td>1</td> <td>Set 3</td> </tr> <tr> <td>1</td> <td>1</td> <td>Set 4</td> </tr> </tbody> </table>	Status of source defined by par. <a href="#">96.12</a>	Status of source defined by par. <a href="#">96.13</a>	User parameter set selected	0	0	Set 1	1	0	Set 2	0	1	Set 3	1	1	Set 4	
Status of source defined by par. <a href="#">96.12</a>	Status of source defined by par. <a href="#">96.13</a>	User parameter set selected																
0	0	Set 1																
1	0	Set 2																
0	1	Set 3																
1	1	Set 4																
	Off	0.	0															
	On	1.	1															
	DI1	Digital input DI1 ( <a href="#">10.02 DI delayed status</a> , bit 0).	2															
	DI2	Digital input DI2 ( <a href="#">10.02 DI delayed status</a> , bit 1).	3															
	DI3	Digital input DI3 ( <a href="#">10.02 DI delayed status</a> , bit 2).	4															
	DI4	Digital input DI4 ( <a href="#">10.02 DI delayed status</a> , bit 3).	5															
	DI5	Digital input DI5 ( <a href="#">10.02 DI delayed status</a> , bit 4).	6															
	DI6	Digital input DI6 ( <a href="#">10.02 DI delayed status</a> , bit 5).	7															
	DIO1	Digital input/output DIO1 ( <a href="#">11.02 DIO delayed status</a> , bit 0).	10															
	DIO2	Digital input/output DIO2 ( <a href="#">11.02 DIO delayed status</a> , bit 1).	11															
	Other (bit)	Source selection (see <a href="#">Terms and abbreviations</a> on page 81).	-															

No.	Name/Value	Description	Def/FbEq16
96.13	<i>User set IO sel in2</i>	See parameter <a href="#">96.12 User set IO sel in1</a> .	
<b>97 Motor control</b>		Switching frequency; slip gain; voltage reserve; flux braking; signal injection; IR compensation.	
97.01	<i>Switching frequency mode</i>	An optimization setting for balancing between control performance and motor noise level.	<i>Normal</i>
	Cyclic	Control performance optimized for cyclic load applications. <b>Note:</b> With this setting, the maximum motor cable length is smaller than with <i>Normal</i> .	0
	Low noise	Minimizes motor noise; control performance optimized for high (> 300 Hz) output frequencies. <b>Note:</b> Drive loadability is reduced with this setting and some derating must be applied if a certain constant output current is needed. This setting is not recommended for cyclic load applications. The maximum motor cable length is 50 m (164 ft) with drives up to 45 kW.	1
	Normal	Control performance optimized for long motor cables.	2
97.03	<i>Slip gain</i>	Defines the slip gain which is used to improve the estimated motor slip. 100% means full slip gain; 0% means no slip gain. The default value is 100%. Other values can be used if a static speed error is detected despite of the full slip gain. <b>Example</b> (with nominal load and nominal slip of 40 rpm): A 1000 rpm constant speed reference is given to the drive. Despite of the full slip gain (= 100%), a manual tachometer measurement from the motor axis gives a speed value of 998 rpm. The static speed error is 1000 rpm - 998 rpm = 2 rpm. To compensate the error, the slip gain should be increased. At the 105% gain value, no static speed error exists (2 rpm / 40 rpm = 5%).	100%
	0 ... 200%	Slip gain.	1 = 1%
97.04	<i>Voltage reserve</i>	Defines the minimum allowed voltage reserve. When the voltage reserve has decreased to the set value, the drive enters the field weakening area. If the intermediate circuit DC voltage $U_{dc} = 550 \text{ V}$ and the voltage reserve is 5%, the RMS value of the maximum output voltage in steady-state operation is $0.95 \times 550 \text{ V} / \text{sqrt}(2) = 369 \text{ V}$ The dynamic performance of the motor control in the field weakening area can be improved by increasing the voltage reserve value, but the drive enters the field weakening area earlier.	0%
	-4 ... 50%	Voltage reserve.	1 = 1%
97.05	<i>Flux braking</i>	Defines the level of braking power.	<i>Disabled</i>
	Disabled	Flux braking is disabled.	0
	Moderate	Flux level is limited during the braking. Deceleration time is longer compared to full braking.	1
	Full	Maximum braking power. Almost all available current is used to convert the mechanical braking energy to thermal energy in the motor.	2
97.06	<i>Flux reference select</i>	Defines the source of flux reference.	<i>User flux reference</i>
	Zero	None.	0
	User flux reference	Parameter <a href="#">97.07 User flux reference</a> .	1

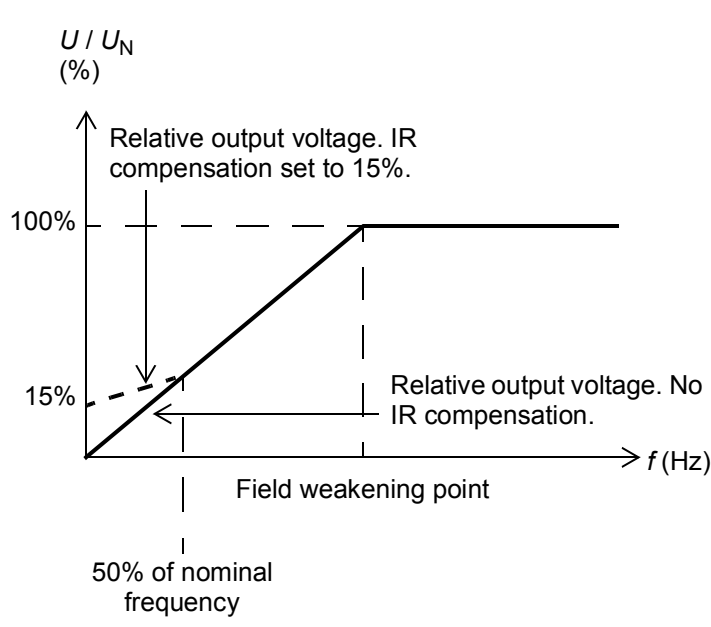
No.	Name/Value	Description	Def/FbEq16
	Other	The value is taken from another parameter.	-
97.07	<i>User flux reference</i>	Defines the flux reference when parameter <i>97.06 Flux reference select</i> is set to <i>User flux reference</i> .	100%
	0...200%	User-defined flux reference.	100 = 1%
97.10	<i>Signal injection</i>	Enables signal injection: a high-frequency alternating signal is injected to the motor in the low speed region to improve the stability of torque control. Signal injection can be enabled with different amplitude levels. <b>Notes:</b> <ul style="list-style-type: none"> <li>• Use as low a level as possible that gives satisfactory performance.</li> <li>• Signal injection cannot be applied to asynchronous motors.</li> </ul>	<i>Disabled</i>
	Disabled	Signal injection disabled.	0
	Enabled (5 %)	Signal injection enabled with amplitude level of 5%.	1
	Enabled (10 %)	Signal injection enabled with amplitude level of 10%.	2
	Enabled (15 %)	Signal injection enabled with amplitude level of 15%.	3
	Enabled (20 %)	Signal injection enabled with amplitude level of 20%.	4
97.11	<i>TR tuning</i>	Rotor time constant tuning. This parameter can be used to improve torque accuracy in closed-loop control of an induction motor. Normally, the motor identification run provides sufficient torque accuracy, but manual fine-tuning can be applied in exceptionally demanding applications to achieve optimal performance.	100%
	25...400%	Rotor time constant tuning.	1 = 1%
97.13	<i>IR compensation</i>	Defines the relative output voltage boost at zero speed (IR compensation). The function is useful in applications with a high break-away torque where direct torque control (DTC mode) cannot be applied.   <p>See also section <i>IR compensation for scalar motor control</i> on page 41.</p>	0.00%
	0.00 ... 50.00%	Voltage boost at zero speed in percent of nominal motor voltage.	1 = 1%



No.	Name/Value	Description	Def/FbEq16
<b>98 User motor parameters</b>		Motor values supplied by the user that are used in the motor model.	
<b>98.01</b>	<b>User motor model</b>	Activates the motor model parameters <b>98.02...98.14</b> and the rotor angle offset parameter <b>98.15</b> . <b>Notes:</b> <ul style="list-style-type: none"> <li>Parameter value is automatically set to zero when ID run is selected by parameter <b>99.13 Identification run request</b>. The values of parameters <b>98.02...98.15</b> are updated according to the motor characteristics identified during the ID run.</li> <li>Measurements made directly from the motor terminals are likely to produce slightly different values than those detected by the ID run.</li> <li>This parameter cannot be changed while the drive is running.</li> </ul>	No
	No	Parameters <b>98.02...98.15</b> inactive.	0
	Motor parameters	The values of parameters <b>98.02...98.14</b> are used in the motor model.	1
	Position offset	The value of parameter <b>98.15</b> is used as the rotor angle offset. Parameters <b>98.02...98.14</b> are inactive.	2
	Motor parameters & position offset	The values of parameters <b>98.02...98.14</b> are used in the motor model, and the value of parameter <b>98.15</b> is used as the rotor angle offset.	3
<b>98.02</b>	<b>Rs user</b>	Defines the stator resistance $R_S$ of the motor model. With a star-connected motor, $R_S$ is the resistance of one winding. With a delta-connected motor, $R_S$ is one-third of the resistance of one winding.	0.00000 p.u.
	0.00000 ... 0.50000 p.u.	Stator resistance in per unit.	-
<b>98.03</b>	<b>Rr user</b>	Defines the rotor resistance $R_R$ of the motor model. <b>Note:</b> This parameter is valid only for asynchronous motors.	0.00000 p.u.
	0.00000 ... 0.50000 p.u.	Rotor resistance in per unit.	-
<b>98.04</b>	<b>Lm user</b>	Defines the main inductance $L_M$ of the motor model. <b>Note:</b> This parameter is valid only for asynchronous motors.	0.00000 p.u.
	0.00000 ... 10.00000 p.u.	Main inductance in per unit.	-
<b>98.05</b>	<b>SigmaL user</b>	Defines the leakage inductance $\sigma L_S$ . <b>Note:</b> This parameter is valid only for asynchronous motors.	0.00000 p.u.
	0.00000 ... 1.00000 p.u.	Leakage inductance in per unit.	-
<b>98.06</b>	<b>Ld user</b>	Defines the direct axis (synchronous) inductance. <b>Note:</b> This parameter is valid only for permanent magnet motors.	0.00000 p.u.
	0.00000 ... 10.00000 p.u.	Direct axis inductance in per unit.	-
<b>98.07</b>	<b>Lq user</b>	Defines the quadrature axis (synchronous) inductance. <b>Note:</b> This parameter is valid only for permanent magnet motors.	0.00000 p.u.
	0.00000 ... 10.00000 p.u.	Quadrature axis inductance in per unit.	-



No.	Name/Value	Description	Def/FbEq16
98.08	<i>PM flux user</i>	Defines the permanent magnet flux. <b>Note:</b> This parameter is valid only for permanent magnet motors.	0.00000 p.u.
	0.00000 ... 2.00000 p.u	Permanent magnet flux in per unit.	-
98.09	<i>Rs user SI</i>	Defines the stator resistance $R_S$ of the motor model.	0.00000 ohm
	0.00000 ... 100.00000 ohm	Stator resistance.	-
98.10	<i>Rr user SI</i>	Defines the rotor resistance $R_R$ of the motor model. <b>Note:</b> This parameter is valid only for asynchronous motors.	0.00000 ohm
	0.00000 ... 100.00000 ohm	Rotor resistance.	-
98.11	<i>Lm user SI</i>	Defines the main inductance $L_M$ of the motor model. <b>Note:</b> This parameter is valid only for asynchronous motors.	0.00 mH
	0.00 ... 100000.00 mH	Main inductance.	1 = 10000 mH
98.12	<i>SigmaL user SI</i>	Defines the leakage inductance $\sigma L_S$ . <b>Note:</b> This parameter is valid only for asynchronous motors.	0.00 mH
	0.00 ... 100000.00 mH	Leakage inductance.	1 = 10000 mH
98.13	<i>Ld user SI</i>	Defines the direct axis (synchronous) inductance. <b>Note:</b> This parameter is valid only for permanent magnet motors.	0.00 mH
	0.00 ... 100000.00 mH	Direct axis inductance.	1 = 10000 mH
98.14	<i>Lq user SI</i>	Defines the quadrature axis (synchronous) inductance. <b>Note:</b> This parameter is valid only for permanent magnet motors.	0.00 mH
	0.00 ... 100000.00 mH	Quadrature axis inductance.	1 = 10000 mH
98.15	<i>Position offset user</i>	Defines an angle offset between the zero position of the synchronous motor and the zero position of the position sensor. <b>Notes:</b> <ul style="list-style-type: none"> <li>The value is in electrical degrees. The electrical angle equals the mechanical angle multiplied by the number of motor pole pairs.</li> <li>This parameter is valid only for permanent magnet motors.</li> </ul>	0°
	0...360°	Angle offset.	1 = 1°
<b>99 Motor data</b>		Motor configuration settings.	
99.03	<i>Motor type</i>	Selects the motor type. <b>Note:</b> This parameter cannot be changed while the drive is running.	<i>Asynchronous motor</i>
	Asynchronous motor	Asynchronous induction motor.	0
	Permanent magnet motor	Permanent magnet motor. Three-phase AC synchronous motor with permanent magnet rotor and sinusoidal BackEMF voltage.	1

No.	Name/Value	Description	Def/FbEq16
99.04	<i>Motor ctrl mode</i>	Selects the motor control mode.	<i>DTC</i>
	DTC	Direct torque control. This mode is suitable for most applications. <b>Note:</b> Instead of direct torque control, use scalar control <ul style="list-style-type: none"> <li>with multimotor applications 1) if the load is not equally shared between the motors, 2) if the motors are of different sizes, or 3) if the motors are going to be changed after the motor identification (ID run)</li> <li>if the nominal current of the motor is less than 1/6 of the nominal output current of the drive</li> <li>if the drive is used with no motor connected (for example, for test purposes).</li> </ul>	0
	Scalar	Scalar control. The outstanding motor control accuracy of DTC cannot be achieved in scalar control. Some standard features are disabled in scalar control mode. <b>Note:</b> Correct motor run requires that the magnetizing current of the motor does not exceed 90% of the nominal current of the inverter. See also section <i>Scalar motor control</i> on page 40.	1
99.06	<i>Motor nominal current</i>	Defines the nominal motor current. Must be equal to the value on the motor rating plate. If multiple motors are connected to the drive, enter the total current of the motors. <b>Notes:</b> <ul style="list-style-type: none"> <li>Correct motor run requires that the magnetizing current of the motor does not exceed 90% of the nominal current of the drive.</li> <li>This parameter cannot be changed while the drive is running.</li> </ul>	0.0 A
	0.0 ... 6400.0 A	Nominal current of the motor. The allowable range is $1/6 \dots 2 \times I_{Hd}$ of the drive ( $0 \dots 2 \times I_{Hd}$ with scalar control mode).	1 = 1 A
99.07	<i>Motor nominal voltage</i>	Defines the nominal motor voltage as fundamental phase-to-phase rms voltage supplied to the motor at the nominal operating point. This setting must match the value on the rating plate of the motor. <b>Notes:</b> <ul style="list-style-type: none"> <li>With permanent magnet motors, the nominal voltage is the BackEMF voltage at nominal speed of the motor. If the voltage is given as voltage per rpm, e.g. 60 V per 1000 rpm, the voltage for a nominal speed of 3000 rpm is <math>3 \times 60 \text{ V} = 180 \text{ V}</math>. Note that the nominal voltage is not equal to the equivalent DC motor voltage (EDCM) specified by some motor manufacturers. The nominal voltage can be calculated by dividing the EDCM voltage by 1.7 (or square root of 3).</li> <li>The stress on the motor insulation is always dependent on the drive supply voltage. This also applies to the case where the motor voltage rating is lower than that of the drive and the supply.</li> <li>This parameter cannot be changed while the drive is running.</li> </ul>	0.0 V
	0.0 ... 800.0	Nominal voltage of the motor.	10 = 1 V
99.08	<i>Motor nominal frequency</i>	Defines the nominal motor frequency. <b>Note:</b> This parameter cannot be changed while the drive is running.	50.0 Hz
	0.0 ... 500.0 Hz	Nominal frequency of the motor.	10 = 1 Hz

No.	Name/Value	Description	Def/FbEq16
99.09	<i>Motor nominal speed</i>	Defines the nominal motor speed. The setting must match the value on the rating plate of the motor. <b>Note:</b> This parameter cannot be changed while the drive is running.	0 rpm
	0 ... 30000 rpm	Nominal speed of the motor.	1 = 1 rpm
99.10	<i>Motor nominal power</i>	Defines the nominal motor power. The setting must match the value on the rating plate of the motor. If multiple motors are connected to the drive, enter the total power of the motors. <b>Note:</b> This parameter cannot be changed while the drive is running.	0.00 kW
	-10000.00 ... 10000.00 kW	Nominal power of the motor.	1 = 1 kW
99.11	<i>Motor nominal cosφii</i>	Defines the cosφii of the motor for a more accurate motor model. (Not applicable to permanent magnet motors.) Not obligatory; if set, should match the value on the rating plate of the motor. <b>Note:</b> This parameter cannot be changed while the drive is running.	0.00
	0.00 ... 1.00	Cosφii of the motor.	100 = 1
99.12	<i>Motor nominal torque</i>	Defines the nominal motor shaft torque for a more accurate motor model. Not obligatory. <b>Note:</b> This parameter cannot be changed while the drive is running.	0.000 N•m
	0.00 ... 4294672329.296 N•m	Nominal motor torque.	1 = 100 N•m
99.13	<i>Identification run request</i>	Selects the type of the motor identification performed at the next start of the drive (for Direct Torque Control). During the identification, the drive will identify the characteristics of the motor for optimum motor control. After the ID run, the drive is stopped. <b>Note:</b> This parameter cannot be changed while the drive is running. Once the ID run is activated, it can be cancelled by stopping the drive: If ID run has already been performed once, parameter is automatically set to NO. If no ID run has been performed yet, parameter is automatically set to <i>Standstill</i> . In this case, the ID run must be performed. <b>Notes:</b> <ul style="list-style-type: none"> <li>ID run cannot be performed if parameter <i>99.04 Motor ctrl mode</i> is set to <i>Scalar</i>.</li> <li>ID run must be performed every time any of the motor parameters (<i>99.04, 99.06...99.12</i>) have been changed. Parameter is automatically set to <i>Standstill</i> after the motor parameters have been set. With a permanent magnet or synchronous reluctance motor, the motor shaft must NOT be locked and the load torque must be &lt; 10% during the ID run (<i>Normal/Reduced/Standstill</i>). For the <i>Advanced</i> ID run, the machinery must always be de-coupled from the motor.</li> <li>Ensure that possible Safe Torque Off and emergency stop circuits are closed during ID run.</li> <li>Mechanical brake is not opened by the logic for the ID run.</li> </ul>	No
	No	No motor ID run is requested. This mode can be selected only if the ID run ( <i>Normal/Reduced/Standstill/Advanced</i> ) has already been performed once.	0

No.	Name/Value	Description	Def/FbEq16
	Normal	<p>Normal ID run. Guarantees good control accuracy for all cases. The ID run takes about 90 seconds. This mode should be selected whenever it is possible.</p> <p><b>Notes:</b></p> <ul style="list-style-type: none"> <li>The driven machinery must be de-coupled from the motor with Normal ID run, if the load torque is higher than 20%, or if the machinery is not able to withstand the nominal torque transient during the ID run.</li> <li>Check the direction of rotation of the motor before starting the ID run. During the run, the motor will rotate in the forward direction.</li> </ul> <p> <b>WARNING!</b> The motor will run at up to approximately 50...100% of the nominal speed during the ID run. ENSURE THAT IT IS SAFE TO RUN THE MOTOR BEFORE PERFORMING THE ID RUN!</p>	1
	Reduced	<p>Reduced ID Run. This mode should be selected instead of the <i>Normal</i> or <i>Advanced</i> ID Run if</p> <ul style="list-style-type: none"> <li>mechanical losses are higher than 20% (i.e. the motor cannot be de-coupled from the driven equipment), or if</li> <li>flux reduction is not allowed while the motor is running (i.e. in case of a motor with an integrated brake supplied from the motor terminals).</li> </ul> <p>With Reduced ID run, the control in the field weakening area or at high torques is not necessarily as accurate as with the Normal ID run. Reduced ID run is completed faster than the Normal ID Run (&lt; 90 seconds).</p> <p><b>Note:</b> Check the direction of rotation of the motor before starting the ID run. During the run, the motor will rotate in the forward direction.</p> <p> <b>WARNING!</b> The motor will run at up to approximately 50...100% of the nominal speed during the ID run. ENSURE THAT IT IS SAFE TO RUN THE MOTOR BEFORE PERFORMING THE ID RUN!</p>	2
	Standstill	<p>Standstill ID run. The motor is injected with DC current. With an asynchronous motor, the motor shaft is not rotating (with permanent magnet motor the shaft can rotate &lt; 0.5 revolution).</p> <p><b>Note:</b> This mode should be selected only if the <i>Normal</i>, <i>Reduced</i> or <i>Advanced</i> ID run is not possible due to the restrictions caused by the connected mechanics (e.g. with lift or crane applications).</p>	3
	Autophasing	<p>During autophasing, the start angle of the motor is determined. Note that other motor model values are not updated. See also parameter <i>21.13 Autophasing mode</i>.</p> <p><b>Notes:</b></p> <ul style="list-style-type: none"> <li>Autophasing can only be selected after the <i>Normal/Reduced/Standstill/Advanced</i> ID run has been performed once. Autophasing is used with a permanent magnet motor when an absolute encoder, a resolver or an encoder with commutation signals has been added or replaced, and there is no need to perform the <i>Normal/Reduced/Standstill/Advanced</i> ID run again.</li> <li>During Autophasing, the motor shaft must NOT be locked and the load torque must be &lt; 5%.</li> </ul>	4
	Current measurement calibration	<p>Current offset and gain measurement calibration. The calibration will be performed at next start.</p>	5

No.	Name/Value	Description	Def/FbEq16
	Advanced	Advanced ID run. Guarantees the best possible control accuracy. The ID run can take a couple of minutes. This mode should be selected when top performance is needed in the whole operating area. <b>Notes:</b> <ul style="list-style-type: none"> <li>The driven machinery must be de-coupled from the motor because of high torque and speed transients that are applied.</li> <li>During the run, the motor may rotate both in the forward and reverse direction.</li> </ul>  <b>WARNING!</b> The motor may run at up to the maximum (positive) and minimum (negative) allowed speed during the ID run. Several accelerations and decelerations are done. The maximum torque, current and speed allowed by the limit parameters may be utilized. ENSURE THAT IT IS SAFE TO RUN THE MOTOR BEFORE PERFORMING THE ID RUN!	6
99.14	<i>Identification run performed</i>	Shows the mode of the ID run that was performed last. For more information of the different modes, see the selections of parameter <i>99.13 Identification run request</i> .	No
	No	No ID run has been performed.	0
	Normal	<i>Normal</i> ID run.	1
	Reduced	<i>Reduced</i> ID run.	2
	Standstill	<i>Standstill</i> ID run.	3
	Autophasing	<i>Autophasing</i> .	4
	Current measurement calibration	<i>Current measurement calibration</i> .	5
	Advanced	<i>Advanced</i> ID run.	6
99.15	<i>Motor polepairs</i>	Calculated number of pole pairs in the motor.	0
	0...1000	Number of pole pairs.	1 = 1
99.16	<i>Phase order</i>	Switches the rotation direction of motor. This parameter can be used if the motor turns in the wrong direction (for example, because of the wrong phase order in the motor cable), and correcting the cabling is considered impractical. <b>Note:</b> After changing this parameter, the sign of encoder feedback (if any) must be checked. This can be done by setting parameter <i>90.41 Motor feedback selection</i> to <i>Estimate</i> , and comparing the sign of <i>90.01 Motor speed for control</i> to <i>90.10 Encoder 1 speed</i> (or <i>90.20 Encoder 2 speed</i> ). If the sign of the measurement is incorrect, the encoder wiring must be corrected or the sign of <i>90.43 Motor gear numerator</i> reversed.	<i>U V W</i>
	U V W	Normal.	0
	U W V	Reversed rotation direction.	1
<b>200 Safety</b>		FSO-xx settings.	
This group contains parameters related to the optional FSO-xx safety functions module. For details on the parameters in this group, refer to the documentation of the FSO-xx module.			



## 7

# Additional parameter data

---

## What this chapter contains

This chapter lists the parameters with some additional data. For parameter descriptions, see chapter [Parameters](#) (page 81).

## Terms and abbreviations

Term	Definition
Actual signal	Signal measured or calculated by the drive. Usually can only be monitored but not adjusted; some counter-type signals can however be reset.
Analog src	The parameter can be set to the value of another parameter by choosing “Other”, and selecting the source parameter from a list. In addition to the “Other” selection, the parameter may offer other pre-selected settings.
Binary src	The value of the parameter can be taken from a specific bit in another parameter value (“Other”). Sometimes the value can be fixed to 0 (false) or 1 (true). In addition, the parameter may offer other pre-selected settings.
Data	Data parameter.
FbEq32	32-bit fieldbus equivalent: The scaling between the value shown on the panel and the integer used in fieldbus communication when a 32-bit value is selected in parameter group <a href="#">52 FBA A data in</a> or <a href="#">53 FBA A data out</a> . The corresponding 16-bit scalings are listed in chapter <a href="#">Parameters</a> (page 81).
List	Selection list.
No.	Parameter number.

---

Term	Definition
PB	Packed Boolean (bit list).
Real	Real number.
Type	Parameter type. See <a href="#">Analog src</a> , <a href="#">Binary src</a> , <a href="#">List</a> , <a href="#">PB</a> , <a href="#">Real</a> .

## Fieldbus addresses

Refer to the *User's Manual* of the fieldbus adapter.



## Parameter groups 1...9

No.	Name	Type	Range	Unit	FbEq32
<b>01 Actual values</b>					
01.01	Motor speed used	<i>Real</i>	-30000.00 ... 30000.00	rpm	100 = 1 rpm
01.02	Motor speed estimated	<i>Real</i>	-30000.00 ... 30000.00	rpm	100 = 1 rpm
01.04	Encoder 1 speed filtered	<i>Real</i>	-30000.00 ... 30000.00	rpm	100 = 1 rpm
01.05	Encoder 2 speed filtered	<i>Real</i>	-30000.00 ... 30000.00	rpm	100 = 1 rpm
01.06	Output frequency	<i>Real</i>	-500.00 ... 500.00	Hz	100 = 1 Hz
01.07	Motor current	<i>Real</i>	0.00 ... 30000.00	A	100 = 1 A
01.10	Motor torque %	<i>Real</i>	-1600.0 ... 1600.0	%	10 = 1%
01.11	DC voltage	<i>Real</i>	0.00 ... 2000.00	V	100 = 1 V
01.13	Output voltage	<i>Real</i>	0...2000	V	
01.14	Output power	<i>Real</i>	-32768.00 ... 32767.00	kW	100 = 1 kW
01.18	Inverter GWh counter	<i>Real</i>	0...65535	GWh	1 = 1 GWh
01.19	Inverter MWh counter	<i>Real</i>	0...999	MWh	1 = 1 MWh
01.20	Inverter kWh counter	<i>Real</i>	0...999	kWh	1 = 1 kWh
01.24	Flux actual %	<i>Real</i>	0...200	%	1 = 1%
01.30	Nominal torque scale	<i>Real</i>	-	N•m	1000 = 1 N•m
01.31	Ambient temperature	<i>Real</i>	-32768.0...32767.0	°C	10 = 1 °C
<b>03 Input references</b>					
03.01	Panel reference	<i>Real</i>	-100000.00 ... 100000.00	-	100 = 1
03.03	Ethernet PC tool reference 1	<i>Real</i>	-30000.00 ... 30000.00	rpm	100 = 1
03.05	FB A reference 1	<i>Real</i>	-100000.00 ... 100000.00	-	100 = 1
03.06	FB A reference 2	<i>Real</i>	-100000.00 ... 100000.00	-	100 = 1
03.11	DDCS controller ref 1	<i>Real</i>	-30000.00 ... 30000.00	-	100 = 1
03.12	DDCS controller ref 2	<i>Real</i>	-30000.00 ... 30000.00	-	100 = 1
03.13	M/F or D2D ref1	<i>Real</i>	-30000.00 ... 30000.00	-	100 = 1
03.14	M/F or D2D ref2	<i>Real</i>	-30000.00 ... 30000.00	-	100 = 1
<b>04 Warnings and faults</b>					
04.01	Tripping fault	<i>Data</i>	0000h...FFFFh	-	1 = 1
04.02	Active fault 2	<i>Data</i>	0000h...FFFFh	-	1 = 1
04.03	Active fault 3	<i>Data</i>	0000h...FFFFh	-	1 = 1
04.04	Active fault 4	<i>Data</i>	0000h...FFFFh	-	1 = 1
04.05	Active fault 5	<i>Data</i>	0000h...FFFFh	-	1 = 1
04.06	Active warning 1	<i>Data</i>	0000h...FFFFh	-	1 = 1
04.07	Active warning 2	<i>Data</i>	0000h...FFFFh	-	1 = 1
04.08	Active warning 3	<i>Data</i>	0000h...FFFFh	-	1 = 1
04.09	Active warning 4	<i>Data</i>	0000h...FFFFh	-	1 = 1
04.10	Active warning 5	<i>Data</i>	0000h...FFFFh	-	1 = 1
04.11	Latest fault	<i>Data</i>	0000h...FFFFh	-	1 = 1
04.12	2nd latest fault	<i>Data</i>	0000h...FFFFh	-	1 = 1
04.13	3rd latest fault	<i>Data</i>	0000h...FFFFh	-	1 = 1

## 274 Additional parameter data

No.	Name	Type	Range	Unit	FbEq32
04.14	4th latest fault	<i>Data</i>	0000h...FFFFh	-	1 = 1
04.15	5th latest fault	<i>Data</i>	0000h...FFFFh	-	1 = 1
04.16	Latest warning	<i>Data</i>	0000h...FFFFh	-	1 = 1
04.17	2nd latest warning	<i>Data</i>	0000h...FFFFh	-	1 = 1
04.18	3rd latest warning	<i>Data</i>	0000h...FFFFh	-	1 = 1
04.19	4th latest warning	<i>Data</i>	0000h...FFFFh	-	1 = 1
04.20	5th latest warning	<i>Data</i>	0000h...FFFFh	-	1 = 1
<b>05 Diagnostics</b>					
05.01	On-time counter	<i>Real</i>	0...4294967295	d	1 = 1 d
05.02	Run-time counter	<i>Real</i>	0...4294967295	d	1 = 1 d
05.04	Fan on-time counter	<i>Real</i>	0...4294967295	d	1 = 1 d
05.11	Inverter temperature %	<i>Real</i>	-40.0 ... 160.0	%	10 = 1%
<b>06 Control and status words</b>					
06.01	Main control word	<i>PB</i>	0000h...FFFFh	-	1 = 1
06.02	Application control word	<i>PB</i>	0000h...FFFFh	-	1 = 1
06.03	FBA A transparent control word	<i>PB</i>	00000000h...FFFFFFFFh	-	1 = 1
06.11	Main status word	<i>PB</i>	0000h...FFFFh	-	1 = 1
06.16	Drive status word 1	<i>PB</i>	0000h...FFFFh	-	1 = 1
06.17	Drive status word 2	<i>PB</i>	0000h...FFFFh	-	1 = 1
06.18	Start inhibit status word	<i>PB</i>	0000h...FFFFh	-	1 = 1
06.19	Speed control status word	<i>PB</i>	0000h...FFFFh	-	1 = 1
06.20	Constant speed status word	<i>PB</i>	0000h...FFFFh	-	1 = 1
06.30	User bit 0 selection	<i>Binary src</i>	-	-	1 = 1
06.31	User bit 1 selection	<i>Binary src</i>	-	-	1 = 1
06.32	User bit 2 selection	<i>Binary src</i>	-	-	1 = 1
06.33	User bit 3 selection	<i>Binary src</i>	-	-	1 = 1
<b>07 System info</b>					
07.03	Drive rating id	<i>List</i>	0...999	-	1 = 1
07.04	Firmware name	<i>List</i>	-	-	1 = 1
07.05	Firmware version	<i>Data</i>	-	-	1 = 1
07.11	Cpu usage	<i>Real</i>	0...100	%	1 = 1%

## Parameter groups 10...99

No.	Name	Type	Range	Unit	FbEq32
<b>10 Standard DI, RO</b>					
10.01	DI status	<i>PB</i>	0000h...FFFFh	-	1 = 1
10.02	DI delayed status	<i>PB</i>	0000h...FFFFh	-	1 = 1
10.03	DI force selection	<i>PB</i>	0000h...FFFFh	-	1 = 1
10.04	DI force data	<i>PB</i>	0000h...FFFFh	-	1 = 1
10.05	DI1 ON delay	<i>Real</i>	0.0 ... 3000.0	s	10 = 1 s
10.06	DI1 OFF delay	<i>Real</i>	0.0 ... 3000.0	s	10 = 1 s
10.07	DI2 ON delay	<i>Real</i>	0.0 ... 3000.0	s	10 = 1 s
10.08	DI2 OFF delay	<i>Real</i>	0.0 ... 3000.0	s	10 = 1 s
10.09	DI3 ON delay	<i>Real</i>	0.0 ... 3000.0	s	10 = 1 s
10.10	DI3 OFF delay	<i>Real</i>	0.0 ... 3000.0	s	10 = 1 s
10.11	DI4 ON delay	<i>Real</i>	0.0 ... 3000.0	s	10 = 1 s
10.12	DI4 OFF delay	<i>Real</i>	0.0 ... 3000.0	s	10 = 1 s
10.13	DI5 ON delay	<i>Real</i>	0.0 ... 3000.0	s	10 = 1 s
10.14	DI5 OFF delay	<i>Real</i>	0.0 ... 3000.0	s	10 = 1 s
10.15	DI6 ON delay	<i>Real</i>	0.0 ... 3000.0	s	10 = 1 s
10.16	DI6 OFF delay	<i>Real</i>	0.0 ... 3000.0	s	10 = 1 s
10.21	RO status	<i>PB</i>	0000h...FFFFh	-	1 = 1
10.24	RO1 source	<i>Binary src</i>	-	-	1 = 1
10.25	RO1 ON delay	<i>Real</i>	0.0 ... 3000.0	s	10 = 1 s
10.26	RO1 OFF delay	<i>Real</i>	0.0 ... 3000.0	s	10 = 1 s
10.27	RO2 source	<i>Binary src</i>	-	-	1 = 1
10.28	RO2 ON delay	<i>Real</i>	0.0 ... 3000.0	s	10 = 1 s
10.29	RO2 OFF delay	<i>Real</i>	0.0 ... 3000.0	s	10 = 1 s
10.30	RO3 source	<i>Binary src</i>	-	-	1 = 1
10.31	RO3 ON delay	<i>Real</i>	0.0 ... 3000.0	s	10 = 1 s
10.32	RO3 OFF delay	<i>Real</i>	0.0 ... 3000.0	s	10 = 1 s
<b>11 Standard DIO, FI, FO</b>					
11.01	DIO status	<i>PB</i>	0000h...FFFFh	-	1 = 1
11.02	DIO delayed status	<i>PB</i>	0000h...FFFFh	-	1 = 1
11.05	DIO1 configuration	<i>List</i>	0...2	-	1 = 1
11.06	DIO1 output source	<i>Binary src</i>	-	-	1 = 1
11.07	DIO1 ON delay	<i>Real</i>	0.0 ... 3000.0	s	10 = 1 s
11.08	DIO1 OFF delay	<i>Real</i>	0.0 ... 3000.0	s	10 = 1 s
11.09	DIO2 configuration	<i>List</i>	0...2	-	1 = 1
11.10	DIO2 output source	<i>Binary src</i>	-	-	1 = 1

276 Additional parameter data

No.	Name	Type	Range	Unit	FbEq32
11.11	DIO2 ON delay	<i>Real</i>	0.0 ... 3000.0	s	10 = 1 s
11.12	DIO2 OFF delay	<i>Real</i>	0.0 ... 3000.0	s	10 = 1 s
11.38	Freq in 1 actual value	<i>Real</i>	0...16000	Hz	1 = 1 Hz
11.39	Freq in 1 scaled	<i>Real</i>	-32768.000 ... 32767.000	-	1000 = 1
11.42	Freq in 1 min	<i>Real</i>	0...16000	Hz	1 = 1 Hz
11.43	Freq in 1 max	<i>Real</i>	0...16000	Hz	1 = 1 Hz
11.44	Freq in 1 scaled at min	<i>Real</i>	-32768.000 ... 32767.000	-	1000 = 1
11.45	Freq in 1 scaled at max	<i>Real</i>	-32768.000 ... 32767.000	-	1000 = 1
11.54	Freq out 1 actual value	<i>Real</i>	0...16000	Hz	1 = 1 Hz
11.55	Freq out 1 source	<i>Analog src</i>	-	-	1 = 1
11.58	Freq out 1 src min	<i>Real</i>	-32768.000 ... 32767.000	-	1000 = 1
11.59	Freq out 1 src max	<i>Real</i>	-32768.000 ... 32767.000	-	1000 = 1
11.60	Freq out 1 at src min	<i>Real</i>	0...16000	Hz	1 = 1 Hz
11.61	Freq out 1 at src max	<i>Real</i>	0...16000	Hz	1 = 1 Hz
<b>12 Standard AI</b>					
12.11	AI1 actual value	<i>Real</i>	-22.000 ... 22.000	mA or V	1000 = 1 unit
12.12	AI1 scaled value	<i>Real</i>	-32768.000 ... 32767.000	-	1000 = 1
12.15	AI1 unit selection	<i>List</i>	-	-	1 = 1
12.16	AI1 filter time	<i>Real</i>	0.000 ... 30.000	s	1000 = 1 s
12.17	AI1 min	<i>Real</i>	-22.000 ... 22.000	mA or V	1000 = 1 mA or V
12.18	AI1 max	<i>Real</i>	-22.000 ... 22.000	mA or V	1000 = 1 mA or V
12.19	AI1 scaled at AI1 min	<i>Real</i>	-32768.000 ... 32767.000	-	1000 = 1
12.20	AI1 scaled at AI1 max	<i>Real</i>	-32768.000 ... 32767.000	-	1000 = 1
12.21	AI2 actual value	<i>Real</i>	-22.000 ... 22.000	mA or V	1000 = 1 mA or V
12.22	AI2 scaled value	<i>Real</i>	-32768.000 ... 32767.000	-	1000 = 1
12.25	AI2 unit selection	<i>List</i>	-	-	1 = 1
12.26	AI2 filter time	<i>Real</i>	0.000 ... 30.000	s	1000 = 1 s
12.27	AI2 min	<i>Real</i>	-22.000 ... 22.000	mA or V	1000 = 1 mA or V
12.28	AI2 max	<i>Real</i>	-22.000 ... 22.000	mA or V	1000 = 1 mA or V
12.29	AI2 scaled at AI2 min	<i>Real</i>	-32768.000 ... 32767.000	-	1000 = 1
12.30	AI2 scaled at AI2 max	<i>Real</i>	-32768.000 ... 32767.000	-	1000 = 1
<b>13 Standard AO</b>					
13.11	AO1 actual value	<i>Real</i>	0.000 ... 22.000	mA	1000 = 1 mA
13.12	AO1 source	<i>Analog src</i>	-	-	1 = 1
13.16	AO1 filter time	<i>Real</i>	0.000 ... 30.000	s	1000 = 1 s
13.17	AO1 source min	<i>Real</i>	-32768.0 ... 32767.0	-	10 = 1

No.	Name	Type	Range	Unit	FbEq32
13.18	AO1 source max	<i>Real</i>	-32768.0 ... 32767.0	-	10 = 1
13.19	AO1 out at AO1 src min	<i>Real</i>	0.000 ... 22.000	mA	1000 = 1 mA
13.20	AO1 out at AO1 src max	<i>Real</i>	0.000 ... 22.000	mA	1000 = 1 mA
13.21	AO2 actual value	<i>Real</i>	0.000 ... 22.000	mA	1000 = 1 mA
13.22	AO2 source	<i>Analog src</i>	-	-	1 = 1
13.26	AO2 filter time	<i>Real</i>	0.000 ... 30.000	s	1000 = 1 s
13.27	AO2 source min	<i>Real</i>	-32768.0 ... 32767.0	-	10 = 1
13.28	AO2 source max	<i>Real</i>	-32768.0 ... 32767.0	-	10 = 1
13.29	AO2 out at AO2 src min	<i>Real</i>	0.000 ... 22.000	mA	1000 = 1 mA
13.30	AO2 out at AO2 src max	<i>Real</i>	0.000 ... 22.000	mA	1000 = 1 mA
<b>14 I/O extension module 1</b>					
14.01	Module 1 type	<i>List</i>	0...2	-	1 = 1
14.02	Module 1 location	<i>Real</i>	1...254	-	1 = 1
14.03	Module 1 status	<i>List</i>	0...4	-	1 = 1
14.05	DIO status	<i>PB</i>	00000000h...FFFFFFFFh	-	1 = 1
14.06	DIO delayed status	<i>PB</i>	00000000h...FFFFFFFFh	-	1 = 1
14.09	DIO1 configuration	<i>List</i>	0...1	-	1 = 1
14.10	DIO1 filter gain (Not visible when <a href="#">14.01 Module 1 type = FIO-01</a> )	<i>List</i>	0...3	-	1 = 1
14.11	DIO1 output source	<i>Binary src</i>	-	-	1 = 1
14.12	DIO1 ON delay	<i>Real</i>	0.0 ... 3000.0	s	10 = 1 s
14.13	DIO1 OFF delay	<i>Real</i>	0.0 ... 3000.0	s	10 = 1 s
14.14	DIO2 configuration	<i>List</i>	0...1	-	1 = 1
14.15	DIO2 filter gain (Not visible when <a href="#">14.01 Module 1 type = FIO-01</a> )	<i>List</i>	0...3	-	1 = 1
14.16	DIO2 output source	<i>Binary src</i>	-	-	1 = 1
14.17	DIO2 ON delay	<i>Real</i>	0.0 ... 3000.0	s	10 = 1 s
14.18	DIO2 OFF delay	<i>Real</i>	0.0 ... 3000.0	s	10 = 1 s
<i>Other parameters in this group when parameter <a href="#">14.01 Module 1 type = FIO-01</a></i>					
14.19	DIO3 configuration	<i>List</i>	0...1	-	1 = 1
14.21	DIO3 output source	<i>Binary src</i>	-	-	1 = 1
14.22	DIO3 ON delay	<i>Real</i>	0.0 ... 3000.0	s	10 = 1 s
14.23	DIO3 OFF delay	<i>Real</i>	0.0 ... 3000.0	s	10 = 1 s
14.24	DIO4 configuration	<i>List</i>	0...1	-	1 = 1
14.26	DIO4 output source	<i>Binary src</i>	-	-	1 = 1
14.27	DIO4 ON delay	<i>Real</i>	0.0 ... 3000.0	s	10 = 1 s
14.28	DIO4 OFF delay	<i>Real</i>	0.0 ... 3000.0	s	10 = 1 s

## 278 Additional parameter data

No.	Name	Type	Range	Unit	FbEq32
14.31	RO status	<i>PB</i>	0000h...FFFFh	-	1 = 1
14.34	RO1 source	<i>Binary src</i>	-	-	1 = 1
14.35	RO1 ON delay	<i>Real</i>	0.0 ... 3000.0	s	10 = 1 s
14.36	RO1 OFF delay	<i>Real</i>	0.0 ... 3000.0	s	10 = 1 s
14.37	RO2 source	<i>Binary src</i>	-	-	1 = 1
14.38	RO2 ON delay	<i>Real</i>	0.0 ... 3000.0	s	10 = 1 s
14.39	RO2 OFF delay	<i>Real</i>	0.0 ... 3000.0	s	10 = 1 s
<i>Other parameters in this group when parameter 14.01 Module 1 type = FIO-11</i>					
14.21	AI tune	<i>List</i>	0...6	-	1 = 1
14.22	AI force sel	<i>PB</i>	00000000h...FFFFFFFFh	-	1 = 1
14.26	AI1 actual value	<i>Real</i>	-22.000 ... 22.000	mA or V	1000 = 1 unit
14.27	AI1 scaled value	<i>Real</i>	-32768.000 ... 32767.000	-	1000 = 1
14.28	AI1 force data	<i>Real</i>	-22.000 ... 22.000	mA or V	1000 = 1 unit
14.29	AI1 HW switch pos	<i>List</i>	-	-	1 = 1
14.30	AI1 unit selection	<i>List</i>	-	-	1 = 1
14.31	AI1 filter gain	<i>List</i>	0...7	-	1 = 1
14.32	AI1 filter time	<i>Real</i>	0.000 ... 30.000	s	1000 = 1 s
14.33	AI1 min	<i>Real</i>	-22.000 ... 22.000	mA or V	1000 = 1 mA or V
14.34	AI1 max	<i>Real</i>	-22.000 ... 22.000	mA or V	1000 = 1 mA or V
14.35	AI1 scaled at AI1 min	<i>Real</i>	-32768.000 ... 32767.000	-	1000 = 1
14.36	AI1 scaled at AI1 max	<i>Real</i>	-32768.000 ... 32767.000	-	1000 = 1
14.41	AI2 actual value	<i>Real</i>	-22.000 ... 22.000	mA or V	1000 = 1 unit
14.42	AI2 scaled value	<i>Real</i>	-32768.000 ... 32767.000	-	1000 = 1
14.43	AI2 force data	<i>Real</i>	-22.000 ... 22.000	mA or V	1000 = 1 unit
14.44	AI2 HW switch pos	<i>List</i>	-	-	1 = 1
14.45	AI2 unit selection	<i>List</i>	-	-	1 = 1
14.46	AI2 filter gain	<i>List</i>	0...7	-	1 = 1
14.47	AI2 filter time	<i>Real</i>	0.000 ... 30.000	s	1000 = 1 s
14.48	AI2 min	<i>Real</i>	-22.000 ... 22.000	mA or V	1000 = 1 mA or V
14.49	AI2 max	<i>Real</i>	-22.000 ... 22.000	mA or V	1000 = 1 mA or V
14.50	AI2 scaled at AI2 min	<i>Real</i>	-32768.000 ... 32767.000	-	1000 = 1
14.51	AI2 scaled at AI2 max	<i>Real</i>	-32768.000 ... 32767.000	-	1000 = 1
14.56	AI3 actual value	<i>Real</i>	-22.000 ... 22.000	mA or V	1000 = 1 unit
14.57	AI3 scaled value	<i>Real</i>	-32768.000 ... 32767.000	-	1000 = 1
14.58	AI3 force data	<i>Real</i>	-22.000 ... 22.000	mA or V	1000 = 1 unit
14.59	AI3 HW switch pos	<i>List</i>	-	-	1 = 1
14.60	AI3 unit selection	<i>List</i>	-	-	1 = 1

No.	Name	Type	Range	Unit	FbEq32
14.61	AI3 filter gain	List	0...7	-	1 = 1
14.62	AI3 filter time	Real	0.000 ... 30.000	s	1000 = 1 s
14.63	AI3 min	Real	-22.000 ... 22.000	mA or V	1000 = 1 mA or V
14.64	AI3 max	Real	-22.000 ... 22.000	mA or V	1000 = 1 mA or V
14.65	AI3 scaled at AI3 min	Real	-32768.000 ... 32767.000	-	1000 = 1
14.66	AI3 scaled at AI3 max	Real	-32768.000 ... 32767.000	-	1000 = 1
14.71	AO force selection	PB	00000000h...FFFFFFFFh	-	1 = 1
14.76	AO1 actual value	Real	0.000 ... 22.000	mA	1000 = 1 mA
14.77	AO1 source	Analog src	-	-	1 = 1
14.78	AO1 force data	Real	0.000 ... 22.000	mA	1000 = 1 mA
14.79	AO1 filter time	Real	0.000 ... 30.000	s	1000 = 1 s
14.80	AO1 source min	Real	-32768.0 ... 32767.0	-	10 = 1
14.81	AO1 source max	Real	-32768.0 ... 32767.0	-	10 = 1
14.82	AO1 out at AO1 src min	Real	0.000 ... 22.000	mA	1000 = 1 mA
14.83	AO1 out at AO1 src max	Real	0.000 ... 22.000	mA	1000 = 1 mA
<b>15 I/O extension module 2</b>					
15.01	Module 2 type	List	0...2	-	1 = 1
15.02	Module 2 location	Real	1...254	-	1 = 1
15.03	Module 2 status	List	0...2	-	1 = 1
15.05	DIO status	PB	00000000h...FFFFFFFFh	-	1 = 1
15.06	DIO delayed status	PB	00000000h...FFFFFFFFh	-	1 = 1
15.09	DIO1 configuration	List	0...1	-	1 = 1
15.10	DIO1 filter gain (Not visible when <a href="#">15.01</a> <i>Module 2 type = FIO-01</i> )	List	0...3	-	1 = 1
15.11	DIO1 output source	Binary src	-	-	1 = 1
15.12	DIO1 ON delay	Real	0.0 ... 3000.0	s	10 = 1 s
15.13	DIO1 OFF delay	Real	0.0 ... 3000.0	s	10 = 1 s
15.14	DIO2 configuration	List	0...1	-	1 = 1
15.15	DIO2 filter gain (Not visible when <a href="#">15.01</a> <i>Module 2 type = FIO-01</i> )	List	0...3	-	1 = 1
15.16	DIO2 output source	Binary src	-	-	1 = 1
15.17	DIO2 ON delay	Real	0.0 ... 3000.0	s	10 = 1 s
15.18	DIO2 OFF delay	Real	0.0 ... 3000.0	s	10 = 1 s
<i>Other parameters in this group when parameter <a href="#">15.01</a> Module 2 type = FIO-01</i>					
15.19	DIO3 configuration	List	0...1	-	1 = 1
15.21	DIO3 output source	Binary src	-	-	1 = 1

## 280 Additional parameter data

No.	Name	Type	Range	Unit	FbEq32
15.22	DIO3 ON delay	<i>Real</i>	0.0 ... 3000.0	s	10 = 1 s
15.23	DIO3 OFF delay	<i>Real</i>	0.0 ... 3000.0	s	10 = 1 s
15.24	DIO4 configuration	<i>List</i>	0...1	-	1 = 1
15.26	DIO4 output source	<i>Binary src</i>	-	-	1 = 1
15.27	DIO4 ON delay	<i>Real</i>	0.0 ... 3000.0	s	10 = 1 s
15.28	DIO4 OFF delay	<i>Real</i>	0.0 ... 3000.0	s	10 = 1 s
15.31	RO status	<i>PB</i>	0000h...FFFFh	-	1 = 1
15.34	RO1 source	<i>Binary src</i>	-	-	1 = 1
15.35	RO1 ON delay	<i>Real</i>	0.0 ... 3000.0	s	10 = 1 s
15.36	RO1 OFF delay	<i>Real</i>	0.0 ... 3000.0	s	10 = 1 s
15.37	RO2 source	<i>Binary src</i>	-	-	1 = 1
15.38	RO2 ON delay	<i>Real</i>	0.0 ... 3000.0	s	10 = 1 s
15.39	RO2 OFF delay	<i>Real</i>	0.0 ... 3000.0	s	10 = 1 s
<i>Other parameters in this group when parameter 15.01 Module 2 type = FIO-11</i>					
15.21	AI tune	<i>List</i>	0...6	-	1 = 1
15.22	AI force sel	<i>PB</i>	00000000h...FFFFFFFFh	-	1 = 1
15.26	AI1 actual value	<i>Real</i>	-22.000 ... 22.000	mA or V	1000 = 1 unit
15.27	AI1 scaled value	<i>Real</i>	-32768.000 ... 32767.000	-	1000 = 1
15.28	AI1 force data	<i>Real</i>	-22.000 ... 22.000	mA or V	1000 = 1 unit
15.29	AI1 HW switch pos	<i>List</i>	-	-	1 = 1
15.30	AI1 unit selection	<i>List</i>	-	-	1 = 1
15.31	AI1 filter gain	<i>List</i>	0...7	-	1 = 1
15.32	AI1 filter time	<i>Real</i>	0.000 ... 30.000	s	1000 = 1 s
15.33	AI1 min	<i>Real</i>	-22.000 ... 22.000	mA or V	1000 = 1 mA or V
15.34	AI1 max	<i>Real</i>	-22.000 ... 22.000	mA or V	1000 = 1 mA or V
15.35	AI1 scaled at AI1 min	<i>Real</i>	-32768.000 ... 32767.000	-	1000 = 1
15.36	AI1 scaled at AI1 max	<i>Real</i>	-32768.000 ... 32767.000	-	1000 = 1
15.41	AI2 actual value	<i>Real</i>	-22.000 ... 22.000	mA or V	1000 = 1 unit
15.42	AI2 scaled value	<i>Real</i>	-32768.000 ... 32767.000	-	1000 = 1
15.43	AI2 force data	<i>Real</i>	-22.000 ... 22.000	mA or V	1000 = 1 unit
15.44	AI2 HW switch pos	<i>List</i>	-	-	1 = 1
15.45	AI2 unit selection	<i>List</i>	-	-	1 = 1
15.46	AI2 filter gain	<i>List</i>	0...7	-	1 = 1
15.47	AI2 filter time	<i>Real</i>	0.000 ... 30.000	s	1000 = 1 s
15.48	AI2 min	<i>Real</i>	-22.000 ... 22.000	mA or V	1000 = 1 mA or V
15.49	AI2 max	<i>Real</i>	-22.000 ... 22.000	mA or V	1000 = 1 mA or V



No.	Name	Type	Range	Unit	FbEq32
15.50	AI2 scaled at AI2 min	<i>Real</i>	-32768.000 ... 32767.000	-	1000 = 1
15.51	AI2 scaled at AI2 max	<i>Real</i>	-32768.000 ... 32767.000	-	1000 = 1
15.56	AI3 actual value	<i>Real</i>	-22.000 ... 22.000	mA or V	1000 = 1 unit
15.57	AI3 scaled value	<i>Real</i>	-32768.000 ... 32767.000	-	1000 = 1
15.58	AI3 force data	<i>Real</i>	-22.000 ... 22.000	mA or V	1000 = 1 unit
15.59	AI3 HW switch pos	<i>List</i>	-	-	1 = 1
15.60	AI3 unit selection	<i>List</i>	-	-	1 = 1
15.61	AI3 filter gain	<i>List</i>	0...7	-	1 = 1
15.62	AI3 filter time	<i>Real</i>	0.000 ... 30.000	s	1000 = 1 s
15.63	AI3 min	<i>Real</i>	-22.000 ... 22.000	mA or V	1000 = 1 mA or V
15.64	AI3 max	<i>Real</i>	-22.000 ... 22.000	mA or V	1000 = 1 mA or V
15.65	AI3 scaled at AI3 min	<i>Real</i>	-32768.000 ... 32767.000	-	1000 = 1
15.66	AI3 scaled at AI3 max	<i>Real</i>	-32768.000 ... 32767.000	-	1000 = 1
15.71	AO force selection	<i>PB</i>	00000000h...FFFFFFFFh	-	1 = 1
15.76	AO1 actual value	<i>Real</i>	0.000 ... 22.000	mA	1000 = 1 mA
15.77	AO1 source	<i>Analog src</i>	-	-	1 = 1
15.78	AO1 force data	<i>Real</i>	0.000 ... 22.000	mA	1000 = 1 mA
15.79	AO1 filter time	<i>Real</i>	0.000 ... 30.000	s	1000 = 1 s
15.80	AO1 source min	<i>Real</i>	-32768.0 ... 32767.0	-	10 = 1
15.81	AO1 source max	<i>Real</i>	-32768.0 ... 32767.0	-	10 = 1
15.82	AO1 out at AO1 src min	<i>Real</i>	0.000 ... 22.000	mA	1000 = 1 mA
15.83	AO1 out at AO1 src max	<i>Real</i>	0.000 ... 22.000	mA	1000 = 1 mA
<b>16 I/O extension module 3</b>					
16.01	Module 3 type	<i>List</i>	0...2	-	1 = 1
16.02	Module 3 location	<i>Real</i>	1...254	-	1 = 1
16.03	Module 3 status	<i>List</i>	0...2	-	1 = 1
16.05	DIO status	<i>PB</i>	00000000h...FFFFFFFFh	-	1 = 1
16.06	DIO delayed status	<i>PB</i>	00000000h...FFFFFFFFh	-	1 = 1
16.09	DIO1 configuration	<i>List</i>	0...1	-	1 = 1
16.10	DIO1 filter gain (Not visible when <i>16.01 Module 3 type = FIO-01</i> )	<i>List</i>	0...3	-	1 = 1
16.11	DIO1 output source	<i>Binary src</i>	-	-	1 = 1
16.12	DIO1 ON delay	<i>Real</i>	0.0 ... 3000.0	s	10 = 1 s
16.13	DIO1 OFF delay	<i>Real</i>	0.0 ... 3000.0	s	10 = 1 s
16.14	DIO2 configuration	<i>List</i>	0...1	-	1 = 1
16.15	DIO2 filter gain (Not visible when <i>16.01 Module 3 type = FIO-01</i> )	<i>List</i>	0...3	-	1 = 1

## 282 Additional parameter data

No.	Name	Type	Range	Unit	FbEq32
16.16	DIO2 output source	<i>Binary src</i>	-	-	1 = 1
16.17	DIO2 ON delay	<i>Real</i>	0.0 ... 3000.0	s	10 = 1 s
16.18	DIO2 OFF delay	<i>Real</i>	0.0 ... 3000.0	s	10 = 1 s
<i>Other parameters in this group when parameter 16.01 Module 3 type = FIO-01</i>					
16.19	DIO3 configuration	<i>List</i>	0...1	-	1 = 1
16.21	DIO3 output source	<i>Binary src</i>	-	-	1 = 1
16.22	DIO3 ON delay	<i>Real</i>	0.0 ... 3000.0	s	10 = 1 s
16.23	DIO3 OFF delay	<i>Real</i>	0.0 ... 3000.0	s	10 = 1 s
16.24	DIO4 configuration	<i>List</i>	0...1	-	1 = 1
16.26	DIO4 output source	<i>Binary src</i>	-	-	1 = 1
16.27	DIO4 ON delay	<i>Real</i>	0.0 ... 3000.0	s	10 = 1 s
16.28	DIO4 OFF delay	<i>Real</i>	0.0 ... 3000.0	s	10 = 1 s
16.31	RO status	<i>PB</i>	0000h...FFFFh	-	1 = 1
16.34	RO1 source	<i>Binary src</i>	-	-	1 = 1
16.35	RO1 ON delay	<i>Real</i>	0.0 ... 3000.0	s	10 = 1 s
16.36	RO1 OFF delay	<i>Real</i>	0.0 ... 3000.0	s	10 = 1 s
16.37	RO2 source	<i>Binary src</i>	-	-	1 = 1
16.38	RO2 ON delay	<i>Real</i>	0.0 ... 3000.0	s	10 = 1 s
16.39	RO2 OFF delay	<i>Real</i>	0.0 ... 3000.0	s	10 = 1 s
<i>Other parameters in this group when parameter 16.01 Module 1 type = FIO-11</i>					
16.21	AI tune	<i>List</i>	0...6	-	1 = 1
16.22	AI force sel	<i>PB</i>	00000000h...FFFFFFFh	-	1 = 1
16.26	AI1 actual value	<i>Real</i>	-22.000 ... 22.000	mA or V	1000 = 1 unit
16.27	AI1 scaled value	<i>Real</i>	-32768.000 ... 32767.000	-	1000 = 1
16.28	AI1 force data	<i>Real</i>	-22.000 ... 22.000	mA or V	1000 = 1 unit
16.29	AI1 HW switch pos	<i>List</i>	-	-	1 = 1
16.30	AI1 unit selection	<i>List</i>	-	-	1 = 1
16.31	AI1 filter gain	<i>List</i>	0...7	-	1 = 1
16.32	AI1 filter time	<i>Real</i>	0.000 ... 30.000	s	1000 = 1 s
16.33	AI1 min	<i>Real</i>	-22.000 ... 22.000	mA or V	1000 = 1 mA or V
16.34	AI1 max	<i>Real</i>	-22.000 ... 22.000	mA or V	1000 = 1 mA or V
16.35	AI1 scaled at AI1 min	<i>Real</i>	-32768.000 ... 32767.000	-	1000 = 1
16.36	AI1 scaled at AI1 max	<i>Real</i>	-32768.000 ... 32767.000	-	1000 = 1
16.41	AI2 actual value	<i>Real</i>	-22.000 ... 22.000	mA or V	1000 = 1 unit
16.42	AI2 scaled value	<i>Real</i>	-32768.000 ... 32767.000	-	1000 = 1
16.43	AI2 force data	<i>Real</i>	-22.000 ... 22.000	mA or V	1000 = 1 unit

No.	Name	Type	Range	Unit	FbEq32
16.44	AI2 HW switch pos	List	-	-	1 = 1
16.45	AI2 unit selection	List	-	-	1 = 1
16.46	AI2 filter gain	List	0...7	-	1 = 1
16.47	AI2 filter time	Real	0.000 ... 30.000	s	1000 = 1 s
16.48	AI2 min	Real	-22.000 ... 22.000	mA or V	1000 = 1 mA or V
16.49	AI2 max	Real	-22.000 ... 22.000	mA or V	1000 = 1 mA or V
16.50	AI2 scaled at AI2 min	Real	-32768.000 ... 32767.000	-	1000 = 1
16.51	AI2 scaled at AI2 max	Real	-32768.000 ... 32767.000	-	1000 = 1
16.56	AI3 actual value	Real	-22.000 ... 22.000	mA or V	1000 = 1 unit
16.57	AI3 scaled value	Real	-32768.000 ... 32767.000	-	1000 = 1
16.58	AI3 force data	Real	-22.000 ... 22.000	mA or V	1000 = 1 unit
16.59	AI3 HW switch pos	List	-	-	1 = 1
16.60	AI3 unit selection	List	-	-	1 = 1
16.61	AI3 filter gain	List	0...7	-	1 = 1
16.62	AI3 filter time	Real	0.000 ... 30.000	s	1000 = 1 s
16.63	AI3 min	Real	-22.000 ... 22.000	mA or V	1000 = 1 mA or V
16.64	AI3 max	Real	-22.000 ... 22.000	mA or V	1000 = 1 mA or V
16.65	AI3 scaled at AI3 min	Real	-32768.000 ... 32767.000	-	1000 = 1
16.66	AI3 scaled at AI3 max	Real	-32768.000 ... 32767.000	-	1000 = 1
16.71	AO force selection	PB	00000000h...FFFFFFFFh	-	1 = 1
16.76	AO1 actual value	Real	0.000 ... 22.000	mA	1000 = 1 mA
16.77	AO1 source	Analog src	-	-	1 = 1
16.78	AO1 force data	Real	0.000 ... 22.000	mA	1000 = 1 mA
16.79	AO1 filter time	Real	0.000 ... 30.000	s	1000 = 1 s
16.80	AO1 source min	Real	-32768.0 ... 32767.0	-	10 = 1
16.81	AO1 source max	Real	-32768.0 ... 32767.0	-	10 = 1
16.82	AO1 out at AO1 src min	Real	0.000 ... 22.000	mA	1000 = 1 mA
16.83	AO1 out at AO1 src max	Real	0.000 ... 22.000	mA	1000 = 1 mA
<b>19 Operation mode</b>					
19.01	Actual operation mode	List	-	-	1 = 1
19.11	Ext1/Ext2 selection	Binary src	-	-	1 = 1
19.12	Ext1 control mode 1	List	1...6	-	1 = 1
19.14	Ext2 control mode 1	List	1...6	-	1 = 1
19.16	Local control mode	List	0...1	-	1 = 1
19.17	Local control disable	List	0...1	-	1 = 1
19.20	Scalar control reference unit	List	0...1	-	1 = 1

## 284 Additional parameter data

No.	Name	Type	Range	Unit	FbEq32
<b>20 Start/stop/direction</b>					
20.01	Ext1 commands	<i>List</i>	-	-	1 = 1
20.02	Ext1 start trigger	<i>List</i>	0...1	-	1 = 1
20.03	Ext1 in1	<i>Binary src</i>	-	-	1 = 1
20.04	Ext1 in2	<i>Binary src</i>	-	-	1 = 1
20.05	Ext1 in3	<i>Binary src</i>	-	-	1 = 1
20.06	Ext2 commands	<i>List</i>	-	-	1 = 1
20.07	Ext2 start trigger	<i>List</i>	0...1	-	1 = 1
20.08	Ext2 in1	<i>Binary src</i>	-	-	1 = 1
20.09	Ext2 in2	<i>Binary src</i>	-	-	1 = 1
20.10	Ext2 in3	<i>Binary src</i>	-	-	1 = 1
20.11	Run enable stop mode	<i>List</i>	0...2	-	1 = 1
20.12	Run enable 1	<i>Binary src</i>	-	-	1 = 1
20.19	Enable start command	<i>Binary src</i>	-	-	1 = 1
20.23	Positive speed reference enable	<i>Binary src</i>	-	-	1 = 1
20.24	Negative speed reference enable	<i>Binary src</i>	-	-	1 = 1
20.25	Jogging enable	<i>Binary src</i>	-	-	1 = 1
20.26	Jogging 1 start	<i>Binary src</i>	-	-	1 = 1
20.27	Jogging 2 start	<i>Binary src</i>	-	-	1 = 1
<b>21 Start/stop mode</b>					
21.01	Start mode	<i>List</i>	0...2	-	1 = 1
21.02	Magnetization time	<i>Real</i>	0...10000	ms	1 = 1 ms
21.03	Stop mode	<i>List</i>	0...1	-	1 = 1
21.04	Emergency stop mode	<i>List</i>	0...2	-	1 = 1
21.05	Emergency stop source	<i>Binary src</i>	-	-	1 = 1
21.06	Zero speed limit	<i>Real</i>	0.00 ... 30000.00	rpm	100 = 1 rpm
21.07	Zero speed delay	<i>Real</i>	0...30000	ms	1 = 1 ms
21.08	DC current control	<i>PB</i>	00b...11b	-	1 = 1
21.09	DC hold speed	<i>Real</i>	0.0 ... 1000.0	rpm	100 = 1 rpm
21.10	DC current reference	<i>Real</i>	0.0 ... 100.0	%	10 = 1%
21.11	Post magnetization time	<i>Real</i>	0...30000	ms	1 = 1 ms
21.13	Autophasing mode	<i>List</i>	0...2	-	1 = 1

No.	Name	Type	Range	Unit	FbEq32
21.18	Auto restart time	<i>Real</i>	0.0, 0.1 ... 5.0	s	10 = 1 s
<b>22 Speed reference selection</b>					
22.01	Speed ref unlimited	<i>Real</i>	-30000.00 ... 30000.00	rpm	100 = 1 rpm
22.11	Speed ref1 selection	<i>Analog src</i>	-	-	1 = 1
22.12	Speed ref2 selection	<i>Analog src</i>	-	-	1 = 1
22.13	Speed ref1 function	<i>List</i>	0...5	-	1 = 1
22.14	Speed ref1/2 selection	<i>Binary src</i>	-	-	1 = 1
22.15	Additive speed ref1	<i>Analog src</i>	-	-	1 = 1
22.16	Speed share	<i>Real</i>	-8.000 ... 8.000	-	1000 = 1
22.17	Additive speed ref2	<i>Analog src</i>	-	-	1 = 1
22.21	Constant speed function	<i>PB</i>	00b...11b	-	1 = 1
22.22	Constant speed sel1	<i>Binary src</i>	-	-	1 = 1
22.23	Constant speed sel2	<i>Binary src</i>	-	-	1 = 1
22.24	Constant speed sel3	<i>Binary src</i>	-	-	1 = 1
22.26	Constant speed 1	<i>Real</i>	-30000.00 ... 30000.00	rpm	100 = 1 rpm
22.27	Constant speed 2	<i>Real</i>	-30000.00 ... 30000.00	rpm	100 = 1 rpm
22.28	Constant speed 3	<i>Real</i>	-30000.00 ... 30000.00	rpm	100 = 1 rpm
22.29	Constant speed 4	<i>Real</i>	-30000.00 ... 30000.00	rpm	100 = 1 rpm
22.30	Constant speed 5	<i>Real</i>	-30000.00 ... 30000.00	rpm	100 = 1 rpm
22.31	Constant speed 6	<i>Real</i>	-30000.00 ... 30000.00	rpm	100 = 1 rpm
22.32	Constant speed 7	<i>Real</i>	-30000.00 ... 30000.00	rpm	100 = 1 rpm
22.41	Speed ref safe	<i>Real</i>	-30000.00 ... 30000.00	rpm	100 = 1 rpm
22.42	Jogging 1 ref	<i>Real</i>	-30000.00 ... 30000.00	rpm	100 = 1 rpm
22.43	Jogging 2 ref	<i>Real</i>	-30000.00 ... 30000.00	rpm	100 = 1 rpm
22.51	Critical speed function	<i>PB</i>	00b...11b	-	1 = 1
22.52	Critical speed 1 low	<i>Real</i>	-30000.00 ... 30000.00	rpm	100 = 1 rpm
22.53	Critical speed 1 high	<i>Real</i>	-30000.00 ... 30000.00	rpm	100 = 1 rpm
22.54	Critical speed 2 low	<i>Real</i>	-30000.00 ... 30000.00	rpm	100 = 1 rpm
22.55	Critical speed 2 high	<i>Real</i>	-30000.00 ... 30000.00	rpm	100 = 1 rpm
22.56	Critical speed 3 low	<i>Real</i>	-30000.00 ... 30000.00	rpm	100 = 1 rpm
22.57	Critical speed 3 high	<i>Real</i>	-30000.00 ... 30000.00	rpm	100 = 1 rpm
22.81	Speed reference 1 act	<i>Real</i>	-30000.00 ... 30000.00	rpm	100 = 1 rpm
22.82	Speed reference 2 act	<i>Real</i>	-30000.00 ... 30000.00	rpm	100 = 1 rpm
22.83	Speed reference 3 act	<i>Real</i>	-30000.00 ... 30000.00	rpm	100 = 1 rpm
22.84	Speed reference 4 act	<i>Real</i>	-30000.00 ... 30000.00	rpm	100 = 1 rpm
22.85	Speed reference 5 act	<i>Real</i>	-30000.00 ... 30000.00	rpm	100 = 1 rpm

286 Additional parameter data

No.	Name	Type	Range	Unit	FbEq32
22.86	Speed reference 6 act	<i>Real</i>	-30000.00 ... 30000.00	rpm	100 = 1 rpm
22.87	Speed reference 7 act	<i>Real</i>	-30000.00 ... 30000.00	rpm	100 = 1 rpm
<b>23 Speed reference ramp</b>					
23.01	Speed ref ramp in	<i>Real</i>	-30000.00 ... 30000.00	rpm	100 = 1 rpm
23.02	Speed ref ramp out	<i>Real</i>	-30000.00 ... 30000.00	rpm	100 = 1 rpm
23.11	Ramp set selection	<i>Binary src</i>	-	-	1 = 1
23.12	Acceleration time 1	<i>Real</i>	0.000 ... 1800.000	s	1000 = 1 s
23.13	Deceleration time 1	<i>Real</i>	0.000 ... 1800.000	s	1000 = 1 s
23.14	Acceleration time 2	<i>Real</i>	0.000 ... 1800.000	s	1000 = 1 s
23.15	Deceleration time 2	<i>Real</i>	0.000 ... 1800.000	s	1000 = 1 s
23.16	Shape time acc 1	<i>Real</i>	0.000 ... 1800.000	s	1000 = 1 s
23.17	Shape time acc 2	<i>Real</i>	0.000 ... 1800.000	s	1000 = 1 s
23.18	Shape time dec 1	<i>Real</i>	0.000 ... 1800.000	s	1000 = 1 s
23.19	Shape time dec 2	<i>Real</i>	0.000 ... 1800.000	s	1000 = 1 s
23.20	Acc time jogging	<i>Real</i>	0.000 ... 1800.000	s	1000 = 1 s
23.21	Dec time jogging	<i>Real</i>	0.000 ... 1800.000	s	1000 = 1 s
23.23	Emergency stop time	<i>Real</i>	0.000 ... 1800.000	s	1000 = 1 s
23.24	Ramp in zero	<i>Binary src</i>	-	-	1 = 1
23.26	Ramp out balance enable	<i>Binary src</i>	-	-	1 = 1
23.27	Ramp out balance ref	<i>Real</i>	-30000.00 ... 30000.00	rpm	100 = 1 rpm
23.28	Variable slope enable	<i>List</i>	0...1	-	1 = 1
23.29	Variable slope rate	<i>Real</i>	2...30000	ms	1 = 1 ms
<b>24 Speed reference conditioning</b>					
24.01	Used speed reference	<i>Real</i>	-30000.00 ... 30000.00	rpm	100 = 1 rpm
24.02	Used actual speed	<i>Real</i>	-30000.00 ... 30000.00	rpm	100 = 1 rpm
24.03	Speed error filtered	<i>Real</i>	-30000.0 ... 30000.0	rpm	100 = 1 rpm
24.04	Speed error negative	<i>Real</i>	-30000.0 ... 30000.0	rpm	100 = 1 rpm
24.11	Speed correction	<i>Real</i>	-10000...10000	-	100 = 1
24.12	Speed error filter time	<i>Real</i>	0...10000	ms	1 = 1 ms
24.41	Speed error window control enable	<i>List</i>	0...1	-	1 = 1
24.43	Speed error window high	<i>Real</i>	0...3000	rpm	100 = 1 rpm
24.44	Speed error window low	<i>Real</i>	0...3000	rpm	100 = 1 rpm
24.46	Speed error step	<i>Real</i>	-3000.0 ... 3000.0	rpm	100 = 1 rpm
<b>25 Speed control</b>					
25.01	Torque reference speed control	<i>Real</i>	-1600.0 ... 1600.0	%	10 = 1%
25.02	Proportional gain	<i>Real</i>	0.00 ... 250.00	-	100 = 1
25.03	Integration time	<i>Real</i>	0.00 ... 1000.00	s	100 = 1 s

No.	Name	Type	Range	Unit	FbEq32
25.04	Derivation time	<i>Real</i>	0.000 ... 10000.000	s	1000 = 1 s
25.05	Derivation filter time	<i>Real</i>	0.0 ... 1000.0	ms	1 = 1 ms
25.06	Acc comp derivation time	<i>Real</i>	0.00 ... 1000.00	s	100 = 1 s
25.07	Acc comp filter time	<i>Real</i>	0.0 ... 1000.0	ms	10 = 1 ms
25.08	Drooping rate	<i>Real</i>	0.00 ... 100.00	%	100 = 1%
25.09	Speed ctrl balance enable	<i>Binary src</i>	-	-	1 = 1
25.10	Speed ctrl balance reference	<i>Real</i>	-300 ... 300	-	10 = 1
25.11	Min torque speed control	<i>Real</i>	-1600.0 ... 0.0	%	10 = 1%
25.12	Max torque speed control	<i>Real</i>	0.0 ... 1600.0	%	10 = 1%
25.15	Proportional gain em stop	<i>Real</i>	0.00 ... 250.00	-	100 = 1
25.53	Torque prop reference	<i>Real</i>	-30000.0 ... 30000.0	%	10 = 1%
25.54	Torque integ reference	<i>Real</i>	-30000.0 ... 30000.0	%	10 = 1%
25.55	Torque der reference	<i>Real</i>	-30000.0 ... 30000.0	%	10 = 1%
25.56	Torque acc compensation	<i>Real</i>	-30000.0 ... 30000.0	%	10 = 1%
25.57	Torque reference unbalanced	<i>Real</i>	-30000.0 ... 30000.0	%	10 = 1%
<b>26 Torque reference chain</b>					
26.01	Torque ref to TC	<i>Real</i>	-1600.0 ... 1600.0	%	10 = 1%
26.02	Torque ref used	<i>Real</i>	-1600.0 ... 1600.0	%	10 = 1%
26.08	Minimum torque ref	<i>Real</i>	-1000.0 ... 0.0	%	10 = 1%
26.09	Maximum torque ref	<i>Real</i>	0.0 ... 1000.0	%	10 = 1%
26.11	Torque ref1 selection	<i>Analog src</i>	-	-	1 = 1
26.12	Torque ref2 selection	<i>Analog src</i>	-	-	1 = 1
26.13	Torque ref1 function	<i>List</i>	0...5	-	1 = 1
26.14	Torque ref1/2 selection	<i>Binary src</i>	-	-	1 = 1
26.15	Load share	<i>Real</i>	-8.000 ... 8.000	-	1000 = 1
26.16	Torque additive 1 source	<i>Analog src</i>	-	-	1 = 1
26.17	Torque ref filter time	<i>Real</i>	0.000 ... 30.000	s	1000 = 1 s
26.18	Torque ramp up time	<i>Real</i>	0.000 ... 60.000	s	1000 = 1 s
26.19	Torque ramp down time	<i>Real</i>	0.000 ... 60.000	s	1000 = 1 s
26.25	Torque additive 2 source	<i>Analog src</i>	-	-	1 = 1
26.26	Force torque ref add 2 zero	<i>Binary src</i>	-	-	1 = 1
26.41	Torque step	<i>Real</i>	-300.00 ... 300.00	%	100 = 1%
26.42	Torque step enable	<i>List</i>	0...1	-	1 = 1
26.70	Torque ref1 actual	<i>Real</i>	-1600.0 ... 1600.0	%	10 = 1%
26.71	Torque ref2 actual	<i>Real</i>	-1600.0 ... 1600.0	%	10 = 1%
26.72	Torque ref3 actual	<i>Real</i>	-1600.0 ... 1600.0	%	10 = 1%

288 Additional parameter data

No.	Name	Type	Range	Unit	FbEq32
26.73	Torque ref4 actual	<i>Real</i>	-1600.0 ... 1600.0	%	10 = 1%
26.74	Torque ref ramp out	<i>Real</i>	-1600.0 ... 1600.0	%	10 = 1%
26.75	Torque ref5 actual	<i>Real</i>	-1600.0 ... 1600.0	%	10 = 1%
26.76	Torque ref6 actual	<i>Real</i>	-1600.0 ... 1600.0	%	10 = 1%
26.77	Torque ref add A actual	<i>Real</i>	-1600.0 ... 1600.0	%	10 = 1%
26.78	Torque ref add B actual	<i>Real</i>	-1600.0 ... 1600.0	%	10 = 1%
26.81	Rush control gain	<i>Real</i>	1.0 ... 10000.0	-	10 = 1
26.82	Rush control integration time	<i>Real</i>	0.1 ... 10.0	s	10 = 1 s
<b>28 Frequency reference chain</b>					
28.01	Frequency ref ramp in	<i>Real</i>	-500.00 ... 500.00	Hz	100 = 1 Hz
28.02	Frequency ref ramp out	<i>Real</i>	-500.00 ... 500.00	Hz	100 = 1 Hz
28.11	Frequency ref1 selection	<i>Analog src</i>	-	-	1 = 1
28.12	Frequency ref2 selection	<i>Analog src</i>	-	-	1 = 1
28.13	Frequency ref1 function	<i>List</i>	0...5	-	1 = 1
28.14	Frequency ref1/2 selection	<i>Binary src</i>	-	-	1 = 1
28.21	Constant frequency function	<i>PB</i>	00b...11b	-	1 = 1
28.22	Constant frequency sel1	<i>Binary src</i>	-	-	1 = 1
28.23	Constant frequency sel2	<i>Binary src</i>	-	-	1 = 1
28.24	Constant frequency sel3	<i>Binary src</i>	-	-	1 = 1
28.26	Constant frequency 1	<i>Real</i>	-500.00 ... 500.00	Hz	100 = 1 Hz
28.27	Constant frequency 2	<i>Real</i>	-500.00 ... 500.00	Hz	100 = 1 Hz
28.28	Constant frequency 3	<i>Real</i>	-500.00 ... 500.00	Hz	100 = 1 Hz
28.29	Constant frequency 4	<i>Real</i>	-500.00 ... 500.00	Hz	100 = 1 Hz
28.30	Constant frequency 5	<i>Real</i>	-500.00 ... 500.00	Hz	100 = 1 Hz
28.31	Constant frequency 6	<i>Real</i>	-500.00 ... 500.00	Hz	100 = 1 Hz
28.32	Constant frequency 7	<i>Real</i>	-500.00 ... 500.00	Hz	100 = 1 Hz
28.41	Frequency ref safe	<i>Real</i>	-500.00 ... 500.00	Hz	100 = 1 Hz
28.51	Critical frequency function	<i>PB</i>	00b...11b	-	1 = 1
28.52	Critical frequency 1 low	<i>Real</i>	-500.00 ... 500.00	Hz	100 = 1 Hz
28.53	Critical frequency 1 high	<i>Real</i>	-500.00 ... 500.00	Hz	100 = 1 Hz
28.54	Critical frequency 2 low	<i>Real</i>	-500.00 ... 500.00	Hz	100 = 1 Hz
28.55	Critical frequency 2 high	<i>Real</i>	-500.00 ... 500.00	Hz	100 = 1 Hz
28.56	Critical frequency 3 low	<i>Real</i>	-500.00 ... 500.00	Hz	100 = 1 Hz
28.57	Critical frequency 3 high	<i>Real</i>	-500.00 ... 500.00	Hz	100 = 1 Hz
28.71	Ramp set selection	<i>Binary src</i>	-	-	1 = 1
28.72	Acceleration time 1	<i>Real</i>	0.000 ... 1800.000	s	1000 = 1 s



No.	Name	Type	Range	Unit	FbEq32
28.73	Deceleration time 1	<i>Real</i>	0.000 ... 1800.000	s	1000 = 1 s
28.74	Acceleration time 2	<i>Real</i>	0.000 ... 1800.000	s	1000 = 1 s
28.75	Deceleration time 2	<i>Real</i>	0.000 ... 1800.000	s	1000 = 1 s
28.76	Ramp in zero	<i>Binary src</i>	-	-	1 = 1
28.77	Ramp hold	<i>Binary src</i>	-	-	1 = 1
28.78	Ramp output balance	<i>Real</i>	-500.00 ... 500.00	Hz	100 = 1 Hz
28.79	Ramp output balance enable	<i>Binary src</i>	-	-	1 = 1
28.90	Frequency ref1 act	<i>Real</i>	-500.00 ... 500.00	Hz	100 = 1 Hz
28.91	Frequency ref2 act	<i>Real</i>	-500.00 ... 500.00	Hz	100 = 1 Hz
28.92	Frequency ref3 act	<i>Real</i>	-500.00 ... 500.00	Hz	100 = 1 Hz
28.96	Frequency ref7 act	<i>Real</i>	-500.00 ... 500.00	Hz	100 = 1 Hz
28.97	Frequency ref unlimited	<i>Real</i>	-500.00 ... 500.00	Hz	100 = 1 Hz
<b>30 Limits</b>					
30.01	Limit word 1	<i>PB</i>	0000h...FFFFh	-	1 = 1
30.02	Torque limit status	<i>PB</i>	0000h...FFFFh	-	1 = 1
30.11	Minimum speed	<i>Real</i>	-30000.00 ... 30000.00	rpm	100 = 1 rpm
30.12	Maximum speed	<i>Real</i>	-30000.00 ... 30000.00	rpm	100 = 1 rpm
30.13	Minimum frequency	<i>Real</i>	-500.00 ... 500.00	Hz	100 = 1 Hz
30.14	Maximum frequency	<i>Real</i>	-500.00 ... 500.00	Hz	100 = 1 Hz
30.17	Maximum current	<i>Real</i>	0.00 ... 30000.00	A	100 = 1 A
30.19	Minimum torque	<i>Real</i>	-1600.0 ... 1600.0	%	10 = 1%
30.20	Maximum torque	<i>Real</i>	-1600.0 ... 1600.0	%	10 = 1%
30.26	Power motoring limit	<i>Real</i>	0.00 ... 600.00	%	100 = 1%
30.27	Power generating limit	<i>Real</i>	-600.00 ... 0.00	%	100 = 1%
30.30	Overvoltage control	<i>List</i>	0...1	-	1 = 1
30.31	Undervoltage control	<i>List</i>	0...1	-	1 = 1
<b>31 Fault functions</b>					
31.01	External event 1 source	<i>Binary src</i>	-	-	1 = 1
31.02	External event 1 type	<i>List</i>	0...1	-	1 = 1
31.03	External event 2 source	<i>Binary src</i>	-	-	1 = 1
31.04	External event 2 type	<i>List</i>	0...1	-	1 = 1
31.05	External event 3 source	<i>Binary src</i>	-	-	1 = 1
31.06	External event 3 type	<i>List</i>	0...1	-	1 = 1
31.07	External event 4 source	<i>Binary src</i>	-	-	1 = 1
31.08	External event 4 type	<i>List</i>	0...1	-	1 = 1
31.09	External event 5 source	<i>Binary src</i>	-	-	1 = 1

## 290 Additional parameter data

No.	Name	Type	Range	Unit	FbEq32
31.10	External event 5 type	List	0...1	-	1 = 1
31.11	Fault reset selection	Binary src	-	-	1 = 1
31.12	Autoreset sel	PB	0000h...FFFFh	-	1 = 1
31.13	Selectable fault	Real	0...65535	-	1 = 1
31.14	Number of trials	Real	0...5	-	1 = 1
31.15	Trial time	Real	1.0 ... 600.0	s	10 = 1 s
31.16	Delay time	Real	0.0 ... 120.0	s	10 = 1 s
31.19	Motor phase loss	List	0...1	-	1 = 1
31.20	Earth fault	List	0...2	-	1 = 1
31.21	Supply phase loss	List	0...1	-	1 = 1
31.22	STO indication run/stop	List	0...5	-	1 = 1
31.23	Cross connection	List	0...1	-	1 = 1
31.24	Stall function	List	0...2	-	1 = 1
31.25	Stall current limit	Real	0.0 ... 1600.0	%	10 = 1%
31.26	Stall speed high	Real	0.0 ... 10000.0	rpm	100 = 1 rpm
31.27	Stall frequency high	Real	0.00 ... 500.00	Hz	100 = 1 Hz
31.28	Stall time	Real	0...3600	s	1 = 1 s
31.30	Speed trip margin	Real	0...10000	rpm	100 = 1 rpm
<b>32 Supervision</b>					
32.01	Supervision status	PB	000b...111b	-	1 = 1
32.05	Supervision 1 function	List	0...6	-	1 = 1
32.06	Supervision 1 action	List	0...2	-	1 = 1
32.07	Supervision 1 signal	Analog src	-	-	1 = 1
32.08	Supervision 1 filter time	Real	0.000 ... 30.000	s	1000 = 1 s
32.09	Supervision 1 low	Real	-21474836.48 ... 21474836.47	-	100 = 1
32.10	Supervision 1 high	Real	-21474836.48 ... 21474836.47	-	100 = 1
32.15	Supervision 2 function	List	0...6	-	1 = 1
32.16	Supervision 2 action	List	0...2	-	1 = 1
32.17	Supervision 2 signal	Analog src	-	-	1 = 1
32.18	Supervision 2 filter time	Real	0.000 ... 30.000	s	1000 = 1 s
32.19	Supervision 2 low	Real	-21474836.48 ... 21474836.47	-	100 = 1
32.20	Supervision 2 high	Real	-21474836.48 ... 21474836.47	-	100 = 1
32.25	Supervision 3 function	List	0...6	-	1 = 1
32.26	Supervision 3 action	List	0...2	-	1 = 1
32.27	Supervision 3 signal	Analog src	-	-	1 = 1
32.28	Supervision 3 filter time	Real	0.000 ... 30.000	s	1000 = 1 s

No.	Name	Type	Range	Unit	FbEq32
32.29	Supervision 3 low	<i>Real</i>	-21474836.48 ... 21474836.47	-	100 = 1
32.30	Supervision 3 high	<i>Real</i>	-21474836.48 ... 21474836.47	-	100 = 1
<b>33 Maintenance timer &amp; counter</b>					
33.01	Counter status	<i>PB</i>	000000b...111111b	-	1 = 1
33.10	On-time 1 actual	<i>Real</i>	0...4294967295	s	1 = 1 s
33.11	On-time 1 limit	<i>Real</i>	0...4294967295	s	1 = 1 s
33.12	On-time 1 function	<i>PB</i>	00b...11b	-	1 = 1
33.13	On-time 1 source	<i>Binary src</i>	-	-	1 = 1
33.14	On-time 1 warning select	<i>List</i>	-	-	1 = 1
33.20	On-time 2 actual	<i>Real</i>	0...4294967295	s	1 = 1 s
33.21	On-time 2 limit	<i>Real</i>	0...4294967295	s	1 = 1 s
33.22	On-time 2 function	<i>PB</i>	00b...11b	-	1 = 1
33.23	On-time 2 source	<i>Binary src</i>	-	-	1 = 1
33.24	On-time 2 warning select	<i>List</i>	-	-	1 = 1
33.30	Edge counter 1 actual	<i>Real</i>	0...4294967295	-	1 = 1
33.31	Edge counter 1 limit	<i>Real</i>	0...4294967295	-	1 = 1
33.32	Edge counter 1 func	<i>PB</i>	0000b...1111b	-	1 = 1
33.33	Edge counter 1 source	<i>Binary src</i>	-	-	1 = 1
33.34	Edge counter 1 divider	<i>Real</i>	1...4294967295	-	1 = 1
33.35	Edge counter 1 warning selection	<i>List</i>	-	-	1 = 1
33.40	Edge counter 2 actual	<i>Real</i>	0...4294967295	-	1 = 1
33.41	Edge counter 2 limit	<i>Real</i>	0...4294967295	-	1 = 1
33.42	Edge counter 2 function	<i>PB</i>	0000b...1111b	-	1 = 1
33.43	Edge counter 2 source	<i>Binary src</i>	-	-	1 = 1
33.44	Edge counter 2 divider	<i>Real</i>	1...4294967295	-	1 = 1
33.45	Edge counter 2 warning selection	<i>List</i>	-	-	1 = 1
33.50	Value counter 1 actual	<i>Real</i>	-2147483008 ... 2147483008	-	1 = 1
33.51	Value counter 1 limit	<i>Real</i>	-2147483008 ... 2147483008	-	1 = 1
33.52	Value counter 1 function	<i>PB</i>	00b...11b	-	1 = 1
33.53	Value counter 1 source	<i>Analog src</i>	-	-	1 = 1
33.54	Value counter 1 divider	<i>Real</i>	0.001 ... 2147483.647	-	1000 = 1
33.55	Value counter 1 warning select	<i>List</i>	-	-	1 = 1
33.60	Value counter 2 actual	<i>Real</i>	-2147483008 ... 2147483008	-	1 = 1

## 292 Additional parameter data

No.	Name	Type	Range	Unit	FbEq32
33.61	Value counter 2 limit	<i>Real</i>	-2147483008 ... 2147483008	-	1 = 1
33.62	Value counter 2 function	<i>PB</i>	00b...11b	-	1 = 1
33.63	Value counter 2 source	<i>Analog src</i>	-	-	1 = 1
33.64	Value counter 2 divider	<i>Real</i>	0.001 ... 2147483.647	-	1000 = 1
33.65	Value counter 2 warning selection	<i>List</i>	-	-	1 = 1
<b>35 Motor thermal protection</b>					
35.01	Motor estimated temperature	<i>Real</i>	-60 ... 1000	°C	1 = 1 °C
35.02	Measured temperature 1	<i>Real</i>	-10 ... 1000	°C or ohm	1 = 1 °C
35.03	Measured temperature 2	<i>Real</i>	-10 ... 1000	°C or ohm	1 = 1 °C
35.10	Supervision 1 protection	<i>List</i>	0...2	-	1 = 1
35.11	Supervision 1 source	<i>List</i>	0...11	-	1 = 1
35.12	Supervision 1 fault limit	<i>Real</i>	-10 ... 1000	°C or ohm	1 = 1 °C
35.13	Supervision 1 warning limit	<i>Real</i>	-10 ... 1000	°C or ohm	1 = 1 °C
35.14	Supervision 1 AI select	<i>Analog src</i>	-	-	1 = 1
35.20	Supervision 2 protection	<i>List</i>	0...2	-	1 = 1
35.21	Supervision 2 source	<i>List</i>	0...11	-	1 = 1
35.22	Supervision 2 fault limit	<i>Real</i>	-10 ... 1000	°C or ohm	1 = 1 °C
35.23	Supervision 2 warning limit	<i>Real</i>	-10 ... 1000	°C or ohm	1 = 1 °C
35.24	Supervision 2 AI select	<i>Analog src</i>	-	-	1 = 1
35.50	Motor ambient temperature	<i>Real</i>	-60...100	°C	1 = 1 °C
35.51	Motor load curve	<i>Real</i>	50...150	%	1 = 1%
35.52	Zero speed load	<i>Real</i>	50...150	%	1 = 1%
35.53	Break point	<i>Real</i>	1.00 ... 500.00	Hz	100 = 1 Hz
35.54	Motor nominal temp rise	<i>Real</i>	0...300	°C	1 = 1 °C
35.55	Motor thermal time const	<i>Real</i>	100...10000	s	1 = 1 s
<b>36 Load analyzer</b>					
36.01	PVL signal	<i>Analog src</i>	-	-	1 = 1
36.02	PVL filter time	<i>Real</i>	0.00 ... 120.00	s	100 = 1 s
36.06	AL2 signal	<i>Analog src</i>	-	-	1 = 1
36.07	AL2 signal base	<i>Real</i>	0.00 ... 32767.00	-	100 = 1
36.09	Reset loggers	<i>List</i>	0...3	-	1 = 1
36.10	PVL peak value	<i>Real</i>	-32768.00 ... 32767.00	-	100 = 1

No.	Name	Type	Range	Unit	FbEq32
36.11	PVL peak date	<i>Data</i>	-	-	1 = 1
36.12	PVL peak time	<i>Data</i>	-	-	1 = 1
36.13	PVL current at peak	<i>Real</i>	-32768.00 ... 32767.00	A	100 = 1 A
36.14	PVL DC voltage at peak	<i>Real</i>	0.00 ... 2000.00	V	100 = 1 V
36.15	PVL speed at peak	<i>Real</i>	-32768.00 ... 32767.00	rpm	100 = 1 rpm
36.16	PVL reset date	<i>Data</i>	-	-	1 = 1
36.17	PVL reset time	<i>Data</i>	-	-	1 = 1
36.20	AL1 0 to 10%	<i>Real</i>	0.00 ... 100.00	%	100 = 1%
36.21	AL1 10 to 20%	<i>Real</i>	0.00 ... 100.00	%	100 = 1%
36.22	AL1 20 to 30%	<i>Real</i>	0.00 ... 100.00	%	100 = 1%
36.23	AL1 30 to 40%	<i>Real</i>	0.00 ... 100.00	%	100 = 1%
36.24	AL1 40 to 50%	<i>Real</i>	0.00 ... 100.00	%	100 = 1%
36.25	AL1 50 to 60%	<i>Real</i>	0.00 ... 100.00	%	100 = 1%
36.26	AL1 60 to 70%	<i>Real</i>	0.00 ... 100.00	%	100 = 1%
36.27	AL1 70 to 80%	<i>Real</i>	0.00 ... 100.00	%	100 = 1%
36.28	AL1 80 to 90%	<i>Real</i>	0.00 ... 100.00	%	100 = 1%
36.29	AL1 over 90%	<i>Real</i>	0.00 ... 100.00	%	100 = 1%
36.40	AL2 0 to 10%	<i>Real</i>	0.00 ... 100.00	%	100 = 1%
36.41	AL2 10 to 20%	<i>Real</i>	0.00 ... 100.00	%	100 = 1%
36.42	AL2 20 to 30%	<i>Real</i>	0.00 ... 100.00	%	100 = 1%
36.43	AL2 30 to 40%	<i>Real</i>	0.00 ... 100.00	%	100 = 1%
36.44	AL2 40 to 50%	<i>Real</i>	0.00 ... 100.00	%	100 = 1%
36.45	AL2 50 to 60%	<i>Real</i>	0.00 ... 100.00	%	100 = 1%
36.46	AL2 60 to 70%	<i>Real</i>	0.00 ... 100.00	%	100 = 1%
36.47	AL2 70 to 80%	<i>Real</i>	0.00 ... 100.00	%	100 = 1%
36.48	AL2 80 to 90%	<i>Real</i>	0.00 ... 100.00	%	100 = 1%
36.49	AL2 over 90%	<i>Real</i>	0.00 ... 100.00	%	100 = 1%
36.50	AL2 reset date	<i>Data</i>	-	-	1 = 1
36.51	AL2 reset time	<i>Data</i>	-	-	1 = 1
<b>40 Process PID set 1</b>					
40.01	Process PID actual value	<i>Real</i>	-32768 ... 32767	rpm, % or Hz	100 = 1 rpm, % or Hz
40.02	Feedback actual value	<i>Real</i>	-32768 ... 32767	rpm, % or Hz	100 = 1 rpm, % or Hz
40.03	Setpoint actual value	<i>Real</i>	-32768 ... 32767	rpm, % or Hz	100 = 1 rpm, % or Hz
40.04	Deviation actual value	<i>Real</i>	-32768 ... 32767	rpm, % or Hz	100 = 1 rpm, % or Hz
40.05	Trim output actual value	<i>Real</i>	-32768 ... 32767	rpm, % or Hz	100 = 1 rpm, % or Hz
40.06	PID status word	<i>PB</i>	0000h...FFFFh	-	1 = 1
40.07	PID operation mode	<i>List</i>	0...2	-	1 = 1

## 294 Additional parameter data

No.	Name	Type	Range	Unit	FbEq32
40.08	Feedback 1 source	<i>Analog src</i>	-	-	1 = 1
40.09	Feedback 2 source	<i>Analog src</i>	-	-	1 = 1
40.10	Feedback function	<i>List</i>	0...11	-	1 = 1
40.11	Feedback filter time	<i>Real</i>	0.000 ... 30.000	s	1000 = 1 s
40.12	Unit selection	<i>List</i>	0...2	-	1 = 1
40.14	Setpoint base	<i>Real</i>	-32768 ... 32767	-	100 = 1
40.15	Output base	<i>Real</i>	-32768 ... 32767	-	100 = 1
40.16	Setpoint 1 source	<i>Analog src</i>	-	-	1 = 1
40.17	Setpoint 2 source	<i>Analog src</i>	-	-	1 = 1
40.18	Setpoint function	<i>List</i>	0...11	-	1 = 1
40.19	Internal setpoint selection 1	<i>Binary src</i>	-	-	1 = 1
40.20	Internal setpoint selection 2	<i>Binary src</i>	-	-	1 = 1
40.21	Internal setpoint 1	<i>Real</i>	-32768.0 ... 32767.0	rpm, % or Hz	100 = 1 rpm, % or Hz
40.22	Internal setpoint 2	<i>Real</i>	-32768.0 ... 32767.0	rpm, % or Hz	100 = 1 rpm, % or Hz
40.23	Internal setpoint 3	<i>Real</i>	-32768.0 ... 32767.0	rpm, % or Hz	100 = 1 rpm, % or Hz
40.24	Internal setpoint 4	<i>Real</i>	-32768.0 ... 32767.0	rpm, % or Hz	100 = 1 rpm, % or Hz
40.25	Setpoint selection	<i>Binary src</i>	-	-	1 = 1
40.26	Setpoint min	<i>Real</i>	-32768.0 ... 32767.0	-	100 = 1
40.27	Setpoint max	<i>Real</i>	-32768.0 ... 32767.0	-	100 = 1
40.28	Setpoint increase time	<i>Real</i>	0.0 ... 1800.0	s	10 = 1 s
40.29	Setpoint decrease time	<i>Real</i>	0.0 ... 1800.0	s	10 = 1 s
40.30	Setpoint freeze enable	<i>Binary src</i>	-	-	1 = 1
40.31	Deviation inversion	<i>Binary src</i>	-	-	1 = 1
40.32	Gain	<i>Real</i>	0.1 ... 100.0	-	100 = 1
40.33	Integration time	<i>Real</i>	0.0 ... 3600.0	s	10 = 1 s
40.34	Derivation time	<i>Real</i>	0.0 ... 10.0	s	1000 = 1 s
40.35	Derivation filter time	<i>Real</i>	0.0 ... 10.0	s	10 = 1 s
40.36	Output min	<i>Real</i>	-32768.0 ... 32767.0	-	10 = 1
40.37	Output max	<i>Real</i>	-32768.0 ... 32767.0	-	10 = 1
40.38	Output freeze enable	<i>Binary src</i>	-	-	1 = 1
40.39	Deadband range	<i>Real</i>	-32768.0 ... 32767.0	-	10 = 1
40.40	Deadband delay	<i>Real</i>	0.0 ... 3600.0	s	10 = 1 s

No.	Name	Type	Range	Unit	FbEq32
40.41	Sleep mode	List	0...2	-	1 = 1
40.42	Sleep enable	Binary src	-	-	1 = 1
40.43	Sleep level	Real	0.0 ... 32767.0	-	10 = 1
40.44	Sleep delay	Real	0.0 ... 3600.0	s	10 = 1 s
40.45	Sleep boost time	Real	0.0 ... 3600.0	s	10 = 1 s
40.46	Sleep boost step	Real	0.0 ... 32767.0	-	10 = 1
40.47	Wake-up deviation	Real	-2147483648 ... 2147483647	rpm, % or Hz	100 = 1 rpm, % or Hz
40.48	Wake up delay	Real	0.00 ... 60.00	s	100 = 1 s
40.49	Tracking mode	Binary src	-	-	1 = 1
40.50	Tracking ref selection	Analog src	-	-	1 = 1
40.51	Trim mode	List	0...3	-	1 = 1
40.52	Trim selection	List	1...3	-	1 = 1
40.53	Trimmed ref pointer	Analog src	-	-	1 = 1
40.54	Trim mix	Real	0.000 ... 1.000	-	1000 = 1
40.55	Trim adjust	Real	-100.000 ... 100.000	-	1000 = 1
40.56	Correction source	List	1...2	-	1 = 1
40.57	Sel between set1 set2	Binary src	-	-	1 = 1
<b>41 Process PID set 2</b>					
41.07	PID operation mode	List	0...2	-	1 = 1
41.08	Feedback 1 source	Analog src	-	-	1 = 1
41.09	Feedback 2 source	Analog src	-	-	1 = 1
41.10	Feedback function	List	0...11	-	1 = 1
41.11	Feedback filter time	Real	0.000 ... 30.000	s	1000 = 1 s
41.12	Unit selection	List	0...2	-	1 = 1
41.14	Setpoint base	Real	-32768 ... 32767	-	100 = 1
41.15	Output base	Real	-32768 ... 32767	-	100 = 1
41.16	Setpoint 1 source	Analog src	-	-	1 = 1
41.17	Setpoint 2 source	Analog src	-	-	1 = 1
41.18	Setpoint function	List	0...11	-	1 = 1
41.19	Internal setpoint selection 1	Binary src	-	-	1 = 1
41.20	Internal setpoint selection 2	Binary src	-	-	1 = 1
41.21	Internal setpoint 1	Real	-32768.0 ... 32767.0	rpm, % or Hz	100 = 1 rpm, % or Hz

296 Additional parameter data

No.	Name	Type	Range	Unit	FbEq32
41.22	Internal setpoint 2	<i>Real</i>	-32768.0 ... 32767.0	rpm, % or Hz	100 = 1 rpm, % or Hz
41.23	Internal setpoint 3	<i>Real</i>	-32768.0 ... 32767.0	rpm, % or Hz	100 = 1 rpm, % or Hz
41.24	Internal setpoint 4	<i>Real</i>	-32768.0 ... 32767.0	rpm, % or Hz	100 = 1 rpm, % or Hz
41.25	Setpoint selection	<i>Binary src</i>	-	-	1 = 1
41.26	Setpoint min	<i>Real</i>	-32768.0 ... 32767.0	-	100 = 1
41.27	Setpoint max	<i>Real</i>	-32768.0 ... 32767.0	-	100 = 1
41.28	Setpoint increase time	<i>Real</i>	0.0 ... 1800.0	s	10 = 1 s
41.29	Setpoint decrease time	<i>Real</i>	0.0 ... 1800.0	s	10 = 1 s
41.30	Setpoint freeze enable	<i>Binary src</i>	-	-	1 = 1
41.31	Deviation inversion	<i>Binary src</i>	-	-	1 = 1
41.32	Gain	<i>Real</i>	0.1 ... 100.0	-	100 = 1
41.33	Integration time	<i>Real</i>	0.0 ... 3600.0	s	10 = 1 s
41.34	Derivation time	<i>Real</i>	0.0 ... 10.0	s	1000 = 1 s
41.35	Derivation filter time	<i>Real</i>	0.0 ... 10.0	s	10 = 1 s
41.36	Output min	<i>Real</i>	-32768.0 ... 32767.0	-	10 = 1
41.37	Output max	<i>Real</i>	-32768.0 ... 32767.0	-	10 = 1
41.38	Output freeze enable	<i>Binary src</i>	-	-	1 = 1
41.39	Deadband range	<i>Real</i>	-32768.0 ... 32767.0	-	10 = 1
41.40	Deadband delay	<i>Real</i>	0.0 ... 3600.0	s	10 = 1 s
41.41	Sleep mode	<i>List</i>	0...2	-	1 = 1
41.42	Sleep enable	<i>Binary src</i>	-	-	1 = 1
41.43	Sleep level	<i>Real</i>	0.0 ... 32767.0	-	10 = 1
41.44	Sleep delay	<i>Real</i>	0.0 ... 3600.0	s	10 = 1 s
41.45	Sleep boost time	<i>Real</i>	0.0 ... 3600.0	s	10 = 1 s
41.46	Sleep boost step	<i>Real</i>	0.0 ... 32767.0	-	10 = 1
41.47	Wake-up deviation	<i>Real</i>	-2147483648 ... 2147483647	rpm, % or Hz	100 = 1 rpm, % or Hz
41.48	Wake-up delay	<i>Real</i>	0.00 ... 60.00	s	100 = 1 s
41.49	Tracking mode	<i>Binary src</i>	-	-	1 = 1
41.50	Tracking ref selection	<i>Analog src</i>	-	-	1 = 1
41.51	Trim mode	<i>List</i>	0...3	-	1 = 1
41.52	Trim selection	<i>List</i>	1...3	-	1 = 1
41.53	Trimmed ref pointer	<i>Analog src</i>	-	-	1 = 1
41.54	Trim mix	<i>Real</i>	0.000 ... 1.000	-	1000 = 1



No.	Name	Type	Range	Unit	FbEq32
41.55	Trim adjust	<i>Real</i>	-100.000 ... 100.000	-	1000 = 1
41.56	Correction source	<i>List</i>	1...2	-	1 = 1
<b>43 Brake chopper</b>					
43.01	Braking resistor temperature	<i>Real</i>	0.0 ... 120.0	%	10 = 1%
43.06	Brake chopper enable	<i>List</i>	0...2	-	1 = 1
43.07	Brake chopper runtime enable	<i>Binary src</i>	-	-	1 = 1
43.08	Brake resistor thermal tc	<i>Real</i>	0...10000	s	1 = 1 s
43.09	Brake resistor Pmax cont	<i>Real</i>	0.10 ... 10000.00	kW	100 = 1 kW
43.10	Brake resistance	<i>Real</i>	0...1000	ohm	10 = 1 ohm
43.11	Brake resistor fault limit	<i>Real</i>	0...150	%	1 = 1%
43.12	Brake resistor warning limit	<i>Real</i>	0...150	%	1 = 1%
<b>44 Mechanical brake control</b>					
44.01	Brake control status	<i>PB</i>	00000000b...11111111b	-	1 = 1
44.02	Brake torque memory	<i>Real</i>	-1600.0 ... 1600.0	%	10 = 1%
44.03	Brake open torque reference	<i>Real</i>	-1000...1000	%	10 = 1%
44.06	Brake control enable	<i>Binary src</i>	-	-	1 = 1
44.07	Brake acknowledge selection	<i>Binary src</i>	-	-	1 = 1
44.08	Brake open delay	<i>Real</i>	0.00 ... 5.00	s	100 = 1 s
44.09	Brake open torque source	<i>Analog src</i>	-	-	1 = 1
44.10	Brake open torque	<i>Real</i>	-1000...1000	%	10 = 1%
44.11	Keep brake closed	<i>Binary src</i>	-	-	1 = 1
44.12	Brake close request	<i>Binary src</i>	-	-	1 = 1
44.13	Brake close delay	<i>Real</i>	0.00 ... 60.00	s	100 = 1 s
44.14	Brake close level	<i>Real</i>	0.0 ... 1000.0	rpm	100 = 1 rpm
44.15	Brake close level delay	<i>Real</i>	0.00 ... 10.00	s	100 = 1 s
44.16	Brake reopen delay	<i>Real</i>	0.00 ... 10.00	s	100 = 1 s
44.17	Brake fault function	<i>List</i>	0...2	-	1 = 1
44.18	Brake fault delay	<i>Real</i>	0.00 ... 60.00	s	100 = 1 s
<b>45 Energy efficiency</b>					
45.01	Saved GW hours	<i>Real</i>	0...65535	GWh	1 = 1 GWh
45.02	Saved MW hours	<i>Real</i>	0...999	MWh	1 = 1 MWh
45.03	Saved kW hours	<i>Real</i>	0.0 ... 999.0	kWh	10 = 1 kWh
45.05	Saved money x1000	<i>Real</i>	0...4294967295	thousand	1 = 1 thousand
45.06	Saved money	<i>Real</i>	0.00 ... 999.99	(selectable)	100 = 1 unit
45.08	CO2 reduction in kilotons	<i>Real</i>	0...65535	metric kiloton	1 = 1 metric kiloton

298 Additional parameter data

No.	Name	Type	Range	Unit	FbEq32
45.09	CO2 reduction in tons	<i>Real</i>	0.0 ... 999.9	metric ton	10 = 1 metric ton
45.11	Energy optimizer	<i>List</i>	0...1	-	1 = 1
45.12	Energy tariff 1	<i>Real</i>	0.000 ... 4294967295.000	(selectable)	1000 = 1 unit
45.13	Energy tariff 2	<i>Real</i>	0.000 ... 4294967295.000	(selectable)	1000 = 1 unit
45.14	Tariff selection	<i>Binary src</i>	-	-	1 = 1
45.17	Tariff currency unit	<i>List</i>	100...102	-	1 = 1
45.18	CO2 conversion factor	<i>Real</i>	0.000 ... 65.535	metric ton/ MWh	1000 = 1 metric ton/MWh
45.19	Comparison power	<i>Real</i>	0.0 ... 10000000.0	kW	10 = 1 kW
45.21	Energy calculations reset	<i>List</i>	0...1	-	1 = 1
<b>46 Monitoring/scaling settings</b>					
46.01	Speed scaling	<i>Real</i>	0.00 ... 30000.00	rpm	100 = 1 rpm
46.02	Frequency scaling	<i>Real</i>	0.10 ... 1000.00	Hz	100 = 1 Hz
46.03	Torque scaling	<i>Real</i>	0.0 ... 30000.0	%	10 = 1%
46.04	Power scaling	<i>Real</i>	0.0 ... 30000.0	kW	10 = 1 kW
46.11	Filter time motor speed	<i>Real</i>	2...20000	ms	1 = 1 ms
46.12	Filter time output frequency	<i>Real</i>	2...20000	ms	1 = 1 ms
46.13	Filter time motor torque	<i>Real</i>	2...20000	ms	1 = 1 ms
46.14	Filter time power out	<i>Real</i>	2...20000	ms	1 = 1 ms
46.21	Speed setpoint hysteresis	<i>Real</i>	0.00 ... 30000.00	rpm	100 = 1 rpm
46.22	Frequency setpoint hysteresis	<i>Real</i>	0.00 ... 1000.00	Hz	100 = 1 Hz
46.23	Torque setpoint hysteresis	<i>Real</i>	0.00 ... 3000.00	%	1 = 1%
46.31	Above speed limit	<i>Real</i>	0.00 ... 30000.00	rpm	100 = 1 rpm
46.32	Above frequency limit	<i>Real</i>	0.00 ... 1000.00	Hz	100 = 1 Hz
46.33	Above torque limit	<i>Real</i>	0.0 ... 300.0	N•m	10 = 1 N•m
<b>47 Data storage</b>					
47.01	Data storage 1 real32	<i>Real</i>	-2147483.008 ... 2147483.008	-	1000 = 1
47.02	Data storage 2 real32	<i>Real</i>	-2147483.008 ... 2147483.008	-	1000 = 1
47.03	Data storage 3 real32	<i>Real</i>	-2147483.008 ... 2147483.008	-	1000 = 1
47.04	Data storage 4 real32	<i>Real</i>	-2147483.008 ... 2147483.008	-	1000 = 1
47.05	Data storage 5 real32	<i>Real</i>	-2147483.008 ... 2147483.008	-	1000 = 1
47.06	Data storage 6 real32	<i>Real</i>	-2147483.008 ... 2147483.008	-	1000 = 1
47.07	Data storage 7 real32	<i>Real</i>	-2147483.008 ... 2147483.008	-	1000 = 1

No.	Name	Type	Range	Unit	FbEq32
47.08	Data storage 8 real32	<i>Real</i>	-2147483.008 ... 2147483.008	-	1000 = 1
47.11	Data storage 1 int32	<i>Real</i>	-2147483648 ... 2147483647	-	1 = 1
47.12	Data storage 2 int32	<i>Real</i>	-2147483648 ... 2147483647	-	1 = 1
47.13	Data storage 3 int32	<i>Real</i>	-2147483648 ... 2147483647	-	1 = 1
47.14	Data storage 4 int32	<i>Real</i>	-2147483648 ... 2147483647	-	1 = 1
47.15	Data storage 5 int32	<i>Real</i>	-2147483648 ... 2147483647	-	1 = 1
47.16	Data storage 6 int32	<i>Real</i>	-2147483648 ... 2147483647	-	1 = 1
47.17	Data storage 7 int32	<i>Real</i>	-2147483648 ... 2147483647	-	1 = 1
47.18	Data storage 8 int32	<i>Real</i>	-2147483648 ... 2147483647	-	1 = 1
47.21	Data storage 1 int16	<i>Real</i>	-32768 ... 32767	-	1 = 1
47.22	Data storage 2 int16	<i>Real</i>	-32768 ... 32767	-	1 = 1
47.23	Data storage 3 int16	<i>Real</i>	-32768 ... 32767	-	1 = 1
47.24	Data storage 4 int16	<i>Real</i>	-32768 ... 32767	-	1 = 1
47.25	Data storage 5 int16	<i>Real</i>	-32768 ... 32767	-	1 = 1
47.26	Data storage 6 int16	<i>Real</i>	-32768 ... 32767	-	1 = 1
47.27	Data storage 7 int16	<i>Real</i>	-32768 ... 32767	-	1 = 1
47.28	Data storage 8 int16	<i>Real</i>	-32768 ... 32767	-	1 = 1
<b>49 Panel port communication</b>					
49.01	Node ID number	<i>Real</i>	1...32	-	1 = 1
49.03	Baud rate	<i>List</i>	1...5	-	1 = 1
49.04	Communication loss time	<i>Real</i>	0.1 ... 3000.0	s	10 = 1 s
49.05	Communication loss action	<i>List</i>	0...3	-	1 = 1
49.06	Refresh settings	<i>List</i>	0...1	-	1 = 1
<b>50 Fieldbus adapter (FBA)</b>					
50.01	FBA A enable	<i>List</i>	0...1	-	1 = 1
50.02	FBA A comm loss func	<i>List</i>	0...3	-	1 = 1
50.03	FBA A comm loss timeout	<i>Real</i>	0.3 ... 6553.5	s	10 = 1 s
50.04	FBA A ref1 type	<i>List</i>	0...10	-	1 = 1
50.05	FBA A ref2 type	<i>List</i>	0...10	-	1 = 1
50.06	FBA A SW sel	<i>List</i>	0...1	-	1 = 1
50.07	FBA A actual 1 type	<i>List</i>	0...10	-	1 = 1
50.08	FBA A actual 2 type	<i>List</i>	0...10	-	1 = 1
50.09	FBA A SW transparent source	<i>Analog src</i>	-	-	1 = 1
50.10	FBA A act1 transparent source	<i>Analog src</i>	-	-	1 = 1

### 300 Additional parameter data

No.	Name	Type	Range	Unit	FbEq32
50.11	FBA A act2 transparent source	<i>Analog src</i>	-	-	1 = 1
50.12	FBA A debug enable	<i>List</i>	0...1	-	1 = 1
50.13	FBA A control word	<i>Data</i>	00000000h ... FFFFFFFFh	-	1 = 1
50.14	FBA A reference 1	<i>Real</i>	-2147483648 ... 2147483647	-	1 = 1
50.15	FBA A reference 2	<i>Real</i>	-2147483648 ... 2147483647	-	1 = 1
50.16	FBA A status word	<i>Data</i>	00000000h ... FFFFFFFFh	-	1 = 1
50.17	FBA A actual value 1	<i>Real</i>	-2147483648 ... 2147483647	-	1 = 1
50.18	FBA A actual value 2	<i>Real</i>	-2147483648 ... 2147483647	-	1 = 1
50.21	FBA A timelevel sel	<i>List</i>	0...3	-	1 = 1
<b>51 FBA A settings</b>					
51.01	FBA type	<i>List</i>	-	-	1 = 1
51.02	FBA Par2	<i>Real</i>	0...65535	-	1 = 1
...	...	...	...	...	
51.26	FBA Par26	<i>Real</i>	0...65535	-	1 = 1
51.27	FBA par refresh	<i>List</i>	0...1	-	1 = 1
51.28	Par table ver	<i>Data</i>	-	-	1 = 1
51.29	Drive type code	<i>Real</i>	0...65535	-	1 = 1
51.30	Mapping file ver	<i>Real</i>	0...65535	-	1 = 1
51.31	D2FBA comm sta	<i>List</i>	0...6	-	1 = 1
51.32	FBA comm SW ver	<i>Data</i>	-	-	1 = 1
51.33	FBA appl SW ver	<i>Data</i>	-	-	1 = 1
<b>52 FBA A data in</b>					
52.01	FBA data in1	<i>List</i>	-	-	1 = 1
...	...	...	...	...	
52.12	FBA data in12	<i>List</i>	-	-	1 = 1
<b>53 FBA A data out</b>					
53.01	FBA data out1	<i>List</i>	-	-	1 = 1
...	...	...	...	...	
53.12	FBA data out12	<i>List</i>	-	-	1 = 1
<b>60 D2D and DDCS communication</b>					
60.01	M/F communication port	<i>List</i>	0...6	-	-
60.02	M/F node address	<i>Real</i>	1...254	-	-
60.03	M/F mode	<i>List</i>	0...2	-	-
60.05	M/F HW connection	<i>List</i>	0...1	-	-
60.07	M/F link control	<i>Real</i>	1...15	-	-
60.08	M/F comm loss timeout	<i>Real</i>	0...65535	ms	-
60.09	M/F comm loss function	<i>List</i>	0...2	-	-

No.	Name	Type	Range	Unit	FbEq32
60.10	M/F ref1 type	List	0...10	-	-
60.11	M/F ref2 type	List	0...10	-	-
60.12	M/F act1 type	List	0...10	-	-
60.13	M/F act2 type	List	0...10	-	-
60.14	M/F follower selection	Real	0...16	-	-
60.51	DDCS controller comm port	List	0...6	-	-
60.52	DDCS controller node address	Real	1...254	-	-
60.55	DDCS controller HW connection	List	0...1	-	-
60.57	DDCS controller link control	Real	1...15	-	-
60.58	DDCS controller comm loss time	Real	0...60000	ms	-
60.59	DDCS controller comm loss action	List	0...3	-	-
60.60	DDCS controller ref1 type	List	0...10	-	-
60.61	DDCS controller ref2 type	List	0...10	-	-
60.62	DDCS controller act1 type	List	0...10	-	-
60.63	DDCS controller act2 type	List	0...10	-	-
<b>61 D2D and DDCS transmit data</b>					
61.01	M/F data 1 selection	List	-	-	-
61.02	M/F data 2 selection	List	-	-	-
61.03	M/F data 3 selection	List	-	-	-
61.25	M/F data 1 value	Real	0...65535	-	-
61.26	M/F data 2 value	Real	0...65535	-	-
61.27	M/F data 3 value	Real	0...65535	-	-
61.51	Data set 11 data 1 selection	List	-	-	-
61.52	Data set 11 data 2 selection	List	-	-	-
61.53	Data set 11 data 3 selection	List	-	-	-
61.54	Data set 13 data 1 selection	List	-	-	-
61.55	Data set 13 data 2 selection	List	-	-	-
61.56	Data set 13 data 3 selection	List	-	-	-
61.57	Data set 15 data 1 selection	List	-	-	-
61.58	Data set 15 data 2 selection	List	-	-	-
61.59	Data set 15 data 3 selection	List	-	-	-
61.60	Data set 17 data 1 selection	List	-	-	-
61.61	Data set 17 data 2 selection	List	-	-	-
61.62	Data set 17 data 3 selection	List	-	-	-
61.63	Data set 19 data 1 selection	List	-	-	-
61.64	Data set 19 data 2 selection	List	-	-	-
61.65	Data set 19 data 3 selection	List	-	-	-
61.66	Data set 21 data 1 selection	List	-	-	-
61.67	Data set 21 data 2 selection	List	-	-	-

## 302 Additional parameter data

No.	Name	Type	Range	Unit	FbEq32
61.68	Data set 21 data 3 selection	<i>List</i>	-	-	-
61.69	Data set 23 data 1 selection	<i>List</i>	-	-	-
61.70	Data set 23 data 2 selection	<i>List</i>	-	-	-
61.71	Data set 23 data 3 selection	<i>List</i>	-	-	-
61.72	Data set 25 data 1 selection	<i>List</i>	-	-	-
61.73	Data set 25 data 2 selection	<i>List</i>	-	-	-
61.74	Data set 25 data 3 selection	<i>List</i>	-	-	-
61.101	Data set 11 data 1 value	<i>Real</i>	0...65535	-	-
61.102	Data set 11 data 2 value	<i>Real</i>	0...65535	-	-
61.103	Data set 11 data 3 value	<i>Real</i>	0...65535	-	-
61.104	Data set 13 data 1 value	<i>Real</i>	0...65535	-	-
61.105	Data set 13 data 2 value	<i>Real</i>	0...65535	-	-
61.106	Data set 13 data 3 value	<i>Real</i>	0...65535	-	-
61.107	Data set 15 data 1 value	<i>Real</i>	0...65535	-	-
61.108	Data set 15 data 2 value	<i>Real</i>	0...65535	-	-
61.109	Data set 15 data 3 value	<i>Real</i>	0...65535	-	-
61.110	Data set 17 data 1 value	<i>Real</i>	0...65535	-	-
61.111	Data set 17 data 2 value	<i>Real</i>	0...65535	-	-
61.112	Data set 17 data 3 value	<i>Real</i>	0...65535	-	-
61.113	Data set 19 data 1 value	<i>Real</i>	0...65535	-	-
61.114	Data set 19 data 2 value	<i>Real</i>	0...65535	-	-
61.115	Data set 19 data 3 value	<i>Real</i>	0...65535	-	-
61.116	Data set 21 data 1 value	<i>Real</i>	0...65535	-	-
61.117	Data set 21 data 2 value	<i>Real</i>	0...65535	-	-
61.118	Data set 21 data 3 value	<i>Real</i>	0...65535	-	-
61.119	Data set 23 data 1 value	<i>Real</i>	0...65535	-	-
61.120	Data set 23 data 2 value	<i>Real</i>	0...65535	-	-
61.121	Data set 23 data 3 value	<i>Real</i>	0...65535	-	-
61.122	Data set 25 data 1 value	<i>Real</i>	0...65535	-	-
61.123	Data set 25 data 2 value	<i>Real</i>	0...65535	-	-
61.124	Data set 25 data 3 value	<i>Real</i>	0...65535	-	-
<b>62 D2D and DDCS receive data</b>					
62.01	M/F data 1 selection	<i>List</i>	-	-	-
62.02	M/F data 2 selection	<i>List</i>	-	-	-
62.03	M/F data 3 selection	<i>List</i>	-	-	-
62.04	Follower node 2 data 1 sel	<i>List</i>	-	-	-
62.05	Follower node 2 data 2 sel	<i>List</i>	-	-	-
62.06	Follower node 2 data 3 sel	<i>List</i>	-	-	-
62.07	Follower node 3 data 1 sel	<i>List</i>	-	-	-
62.08	Follower node 3 data 2 sel	<i>List</i>	-	-	-
62.09	Follower node 3 data 3 sel	<i>List</i>	-	-	-

No.	Name	Type	Range	Unit	FbEq32
62.10	Follower node 4 data 1 sel	List	-	-	-
62.11	Follower node 4 data 2 sel	List	-	-	-
62.12	Follower node 4 data 3 sel	List	-	-	-
62.25	MF/D2D data 1 value	Real	0...65535	-	-
62.26	MF/D2D data 2 value	Real	0...65535	-	-
62.27	MF/D2D data 3 value	Real	0...65535	-	-
62.28	Follower node 2 data 1 value	Real	0...65535	-	-
62.29	Follower node 2 data 2 value	Real	0...65535	-	-
62.30	Follower node 2 data 3 value	Real	0...65535	-	-
62.31	Follower node 3 data 1 value	Real	0...65535	-	-
62.32	Follower node 3 data 2 value	Real	0...65535	-	-
62.33	Follower node 3 data 3 value	Real	0...65535	-	-
62.34	Follower node 4 data 1 value	Real	0...65535	-	-
62.35	Follower node 4 data 2 value	Real	0...65535	-	-
62.36	Follower node 4 data 3 value	Real	0...65535	-	-
62.51	Data set 10 data 1 selection	List	-	-	-
62.52	Data set 10 data 2 selection	List	-	-	-
62.53	Data set 10 data 3 selection	List	-	-	-
62.54	Data set 12 data 1 selection	List	-	-	-
62.55	Data set 12 data 2 selection	List	-	-	-
62.56	Data set 12 data 3 selection	List	-	-	-
62.57	Data set 14 data 1 selection	List	-	-	-
62.58	Data set 14 data 2 selection	List	-	-	-
62.59	Data set 14 data 3 selection	List	-	-	-
62.60	Data set 16 data 1 selection	List	-	-	-
62.61	Data set 16 data 2 selection	List	-	-	-
62.62	Data set 16 data 3 selection	List	-	-	-
62.63	Data set 18 data 1 selection	List	-	-	-
62.64	Data set 18 data 2 selection	List	-	-	-
62.65	Data set 18 data 3 selection	List	-	-	-
62.66	Data set 20 data 1 selection	List	-	-	-
62.67	Data set 20 data 2 selection	List	-	-	-
62.68	Data set 20 data 3 selection	List	-	-	-
62.69	Data set 22 data 1 selection	List	-	-	-
62.70	Data set 22 data 2 selection	List	-	-	-
62.71	Data set 22 data 3 selection	List	-	-	-
62.72	Data set 24 data 1 selection	List	-	-	-
62.73	Data set 24 data 2 selection	List	-	-	-
62.74	Data set 24 data 3 selection	List	-	-	-
62.101	Data set 10 data 1 value	Real	0...65535	-	-
62.102	Data set 10 data 2 value	Real	0...65535	-	-

### 304 Additional parameter data

No.	Name	Type	Range	Unit	FbEq32
62.103	Data set 10 data 3 value	<i>Real</i>	0...65535	-	-
62.104	Data set 12 data 1 value	<i>Real</i>	0...65535	-	-
62.105	Data set 12 data 2 value	<i>Real</i>	0...65535	-	-
62.106	Data set 12 data 3 value	<i>Real</i>	0...65535	-	-
62.107	Data set 14 data 1 value	<i>Real</i>	0...65535	-	-
62.108	Data set 14 data 2 value	<i>Real</i>	0...65535	-	-
62.109	Data set 14 data 3 value	<i>Real</i>	0...65535	-	-
62.110	Data set 16 data 1 value	<i>Real</i>	0...65535	-	-
62.111	Data set 16 data 2 value	<i>Real</i>	0...65535	-	-
62.112	Data set 16 data 3 value	<i>Real</i>	0...65535	-	-
62.113	Data set 18 data 1 value	<i>Real</i>	0...65535	-	-
62.114	Data set 18 data 2 value	<i>Real</i>	0...65535	-	-
62.115	Data set 18 data 3 value	<i>Real</i>	0...65535	-	-
62.116	Data set 20 data 1 value	<i>Real</i>	0...65535	-	-
62.117	Data set 20 data 2 value	<i>Real</i>	0...65535	-	-
62.118	Data set 20 data 3 value	<i>Real</i>	0...65535	-	-
62.119	Data set 22 data 1 value	<i>Real</i>	0...65535	-	-
62.120	Data set 22 data 2 value	<i>Real</i>	0...65535	-	-
62.121	Data set 22 data 3 value	<i>Real</i>	0...65535	-	-
62.122	Data set 24 data 1 value	<i>Real</i>	0...65535	-	-
62.123	Data set 24 data 2 value	<i>Real</i>	0...65535	-	-
62.124	Data set 24 data 3 value	<i>Real</i>	0...65535	-	-
<b>90 Feedback selection</b>					
90.01	Motor speed for control	<i>Real</i>	-21474836.48 ... 21474836.47	rpm	100 = 1 rpm
90.02	Motor position	<i>Real</i>	-21474836.48 ... 21474836.47	rev	100 = 1 rev
90.03	Load speed	<i>Real</i>	-21474836.48 ... 21474836.47	rpm	100 = 1 rpm
90.04	Load position	<i>Real</i>	-2147483648 ... 2147483647	rev	1 = 1 rev
90.05	Load position scaled	<i>Real</i>	-2147483648 ... 2147483647	-	1 = 1
90.10	Encoder 1 speed	<i>Real</i>	-21474836.48 ... 21474836.47	rpm	100 = 1 rpm
90.11	Encoder 1 position	<i>Real</i>	-21474836.48 ... 21474836.47	rev	100 = 1 rev
90.12	Encoder 1 multiturn revolutions	<i>Real</i>	0...4294967295	-	1 = 1
90.13	Encoder 1 revolution extension	<i>Real</i>	-2147483648 ... 2147483647	-	1 = 1
90.14	Encoder 1 position raw	<i>Real</i>	0.00 ... 65535.00	-	100 = 1
90.15	Encoder 1 revolutions raw	<i>Real</i>	0...65535	-	1 = 1



No.	Name	Type	Range	Unit	FbEq32
90.20	Encoder 2 speed	<i>Real</i>	-21474836.48 ... 21474836.47	rpm	100 = 1 rpm
90.21	Encoder 2 position	<i>Real</i>	-21474836.48 ... 21474836.47	rev	100 = 1 rev
90.22	Encoder 2 multiturn revolutions	<i>Real</i>	0...4294967295	-	1 = 1
90.23	Encoder 2 revolution extension	<i>Real</i>	-2147483648 ... 2147483647	-	1 = 1
90.24	Encoder 2 position raw	<i>Real</i>	0...65535	-	100 = 1
90.25	Encoder 2 revolutions raw	<i>Real</i>	0...65535	-	100 = 1
90.26	Motor revolution extension	<i>Real</i>	-2147483648 ... 2147483647	-	1 = 1
90.27	Load revolution extension	<i>Real</i>	-2147483648 ... 2147483647	-	1 = 1
90.41	Motor feedback selection	<i>List</i>	0...2	-	1 = 1
90.42	Motor speed filter time	<i>Real</i>	0...10000	ms	1 = 1 ms
90.43	Motor gear numerator	<i>Real</i>	-32768...32767	-	1 = 1
90.44	Motor gear denominator	<i>Real</i>	-32768...32767	-	1 = 1
90.45	Motor feedback fault	<i>List</i>	0...2	-	1 = 1
90.46	Force open loop	<i>List</i>	0...1	-	1 = 1
90.51	Load feedback selection	<i>List</i>	0...4	-	1 = 1
90.52	Load speed filter time	<i>Real</i>	0...10000	ms	1 = 1 ms
90.53	Load gear numerator	<i>Real</i>	-2147483648 ... 2147483647	-	1 = 1
90.54	Load gear denominator	<i>Real</i>	-2147483648 ... 2147483647	-	1 = 1
90.56	Load position offset	<i>Real</i>	-32768 ... 32767	rev	1 = 1 rev
90.57	Load position resolution	<i>Real</i>	0...32	-	1 = 1
90.61	Gear numerator	<i>Real</i>	-2147483648 ... 2147483647	-	1 = 1
90.62	Gear denominator	<i>Real</i>	-2147483648 ... 2147483647	-	1 = 1
90.63	Feed constant numerator	<i>Real</i>	-2147483648 ... 2147483647	-	1 = 1
90.64	Feed constant denominator	<i>Real</i>	-2147483648 ... 2147483647	-	1 = 1
<b>91 Encoder module settings</b>					
91.01	FEN DI status	<i>PB</i>	000000b...111111b	-	1 = 1
91.02	Module 1 status	<i>List</i>	-	-	1 = 1
91.03	Module 2 status	<i>List</i>	-	-	1 = 1
91.04	Module 1 temperature	<i>Real</i>	0...1000	°C	1 = 1 °C
91.06	Module 2 temperature	<i>Real</i>	0...1000	°C	1 = 1 °C
91.10	Encoder parameter refresh	<i>List</i>	0...1	-	1 = 1
91.11	Module 1 type	<i>List</i>	0...4	-	1 = 1
91.12	Module 1 location	<i>Real</i>	1...254	-	1 = 1

No.	Name	Type	Range	Unit	FbEq32
91.13	Module 2 type	List	0...4	-	1 = 1
91.14	Module 2 location	Real	1...254	-	1 = 1
91.21	Temperature meas sel1	List	0...2	-	1 = 1
91.22	Temperature filtering time 1	Real	0...10000	ms	1 = 1 ms
91.23	PTC filtering 1	Real	0...65535	-	1 = 1
91.24	Temperature meas sel2	List	0...2	-	1 = 1
91.25	Temperature filtering time 2	Real	0...10000	ms	1 = 1 ms
91.26	PTC filtering 2	Real	0...65535	-	1 = 1
<b>92 Encoder 1 configuration</b>					
92.01	Encoder 1 type	List	-	-	1 = 1
92.02	Encoder 1 source	List	1...2	-	1 = 1
92.03	Encoder 1 type act	List	-	-	1 = 1
<i>Other parameters in this group when parameter 92.01 Encoder 1 type = TTL, TTL+ or HTL</i>					
92.10	Pulses/revolution	Real	0...65535	-	1 = 1
92.11	Pulse encoder type	List	0...1	-	1 = 1
92.12	Speed calculation mode	List	0...5	-	1 = 1
92.13	Position estimation enable	List	0...1	-	1 = 1
92.14	Speed estimation enable	List	0...1	-	1 = 1
92.15	Transient filter	List	0...3	-	1 = 1
92.20	Encoder cable fault func	List	0...2	-	1 = 1
92.21	Encoder cable fault mode	List	0...3	-	1 = 1
<i>Other parameters in this group when parameter 92.01 Encoder 1 type = Abs enc</i>					
92.10	Sine/cosine number	Real	0...65535	-	1 = 1
92.11	Absolute position source	List	0...5	-	1 = 1
92.12	Zero pulse enable	List	0...1	-	1 = 1
92.13	Position data width	Real	0...32	-	1 = 1
92.14	Revolution data width	Real	0...32	-	1 = 1
92.30	Serial link mode	List	0...1	-	1 = 1
92.31	EnDat max calculation time	List	0...3	-	1 = 1
92.32	SSI cycle time	List	0...5	-	1 = 1
92.33	SSI clock cycles	Real	2...127	-	1 = 1
92.34	SSI position msb	Real	1...126	-	1 = 1
92.35	SSI revolution msb	Real	1...126	-	1 = 1
92.36	SSI data format	List	0...1	-	1 = 1
92.37	SSI baud rate	List	0...5	-	1 = 1
92.40	SSI zero phase	List	0...3	-	1 = 1
92.45	Hiperface parity	List	0...1	-	1 = 1
92.46	Hiperface baud rate	List	0...3	-	1 = 1
92.47	Hiperface node address	Real	0...255	-	1 = 1
<i>Other parameters in this group when parameter 92.01 Encoder 1 type = Resolver</i>					
92.10	Excitation signal frequency	Real	1...20	kHz	1 = 1 kHz

No.	Name	Type	Range	Unit	FbEq32
92.11	Excitation signal amplitude	<i>Real</i>	4.0 ... 12.0	V	10 = 1 V
92.12	Resolver polepairs	<i>List</i>	1...32	-	1 = 1
<b>93 Encoder 2 configuration</b>					
93.01	Encoder 2 type	<i>List</i>	-	-	1 = 1
93.02	Encoder 2 source	<i>List</i>	1...2	-	1 = 1
93.03	Encoder 2 type act	<i>List</i>	-	-	1 = 1
<i>Other parameters in this group when parameter 93.01 Encoder 2 type = TTL, TTL+ or HTL</i>					
93.10	Pulses/revolution	<i>Real</i>	0...65535	-	1 = 1
93.11	Pulse encoder type	<i>List</i>	0...1	-	1 = 1
93.12	Speed calculation mode	<i>List</i>	0...5	-	1 = 1
93.13	Position estimation enable	<i>List</i>	0...1	-	1 = 1
93.14	Speed estimation enable	<i>List</i>	0...1	-	1 = 1
93.15	Transient filter	<i>List</i>	0...3	-	1 = 1
93.20	Encoder cable fault func	<i>List</i>	0...2	-	1 = 1
93.21	Encoder cable fault mode	<i>List</i>	0...3	-	1 = 1
<i>Other parameters in this group when parameter 93.01 Encoder 2 type = Abs enc</i>					
93.10	Sine/cosine number	<i>Real</i>	0...65535	-	1 = 1
93.11	Absolute position source	<i>List</i>	0...5	-	1 = 1
93.12	Zero pulse enable	<i>List</i>	0...1	-	1 = 1
93.13	Position data width	<i>Real</i>	0...32	-	1 = 1
93.14	Revolution data width	<i>Real</i>	0...32	-	1 = 1
93.30	Serial link mode	<i>List</i>	0...1	-	1 = 1
93.31	EnDat calc time	<i>List</i>	0...3	-	1 = 1
93.32	SSI cycle time	<i>List</i>	0...5	-	1 = 1
93.33	SSI clock cycles	<i>Real</i>	2...127	-	1 = 1
93.34	SSI position msb	<i>Real</i>	1...126	-	1 = 1
93.35	SSI revolution msb	<i>Real</i>	1...126	-	1 = 1
93.36	SSI data format	<i>List</i>	0...1	-	1 = 1
93.37	SSI baud rate	<i>List</i>	0...5	-	1 = 1
93.40	SSI zero phase	<i>List</i>	0...3	-	1 = 1
93.45	Hiperface parity	<i>List</i>	0...1	-	1 = 1
93.46	Hiperface baud rate	<i>List</i>	0...3	-	1 = 1
93.47	Hiperface node address	<i>Real</i>	0...255	-	1 = 1
<i>Other parameters in this group when parameter 93.01 Encoder 2 type = Resolver</i>					
93.10	Excitation signal frequency	<i>Real</i>	1...20	kHz	1 = 1 kHz
93.11	Excitation signal amplitude	<i>Real</i>	4.0 ... 12.0	V	10 = 1 V
93.12	Resolver polepairs	<i>List</i>	1...32	-	1 = 1
<b>95 HW configuration</b>					
95.01	Supply voltage	<i>List</i>	0...6	-	1 = 1
95.02	Adaptive voltage limits	<i>List</i>	0...1	-	1 = 1
95.04	Control board supply	<i>List</i>	0...1	-	1 = 1

### 308 Additional parameter data

No.	Name	Type	Range	Unit	FbEq32
95.08	Forced charging enable	List	0...1	-	1 = 1
95.09	Fuse switch control	List	0...1	-	1 = 1
<b>96 System</b>					
96.01	Language	List	-	-	1 = 1
96.02	Pass code	Data	0...999999999	-	1 = 1
96.04	Macro select	List	0...6	-	1 = 1
96.05	Macro active	List	0...6	-	1 = 1
96.06	Parameter restore	List	-	-	1 = 1
96.07	Parameter save	List	0...1	-	1 = 1
96.08	Control board boot	Real	0...4294967295	-	1 = 1
96.10	User set status	List	-	-	
96.11	User set save/load	List	-	-	
96.12	User set IO sel in1	Binary src	-	-	
96.13	User set IO sel in2	Binary src	-	-	
<b>97 Motor control</b>					
97.01	Switching frequency mode	List	0...2	-	1 = 1
97.03	Slip gain	Real	0...200	%	1 = 1%
97.04	Voltage reserve	Real	-4...50	%	1 = 1%
97.05	Flux braking	List	0...2	-	1 = 1
97.06	Flux reference select	Binary src	-	-	1 = 1
97.07	User flux reference	Real	0...200	%	100 = 1%
97.10	Signal injection	List	0...4	-	1 = 1
97.11	TR tuning	Real	25...400	%	1 = 1%
97.13	IR compensation	Real	0.00 ... 50.00	%	100 = 1%
<b>98 User motor parameters</b>					
98.01	User motor model	List	0...3	-	1 = 1
98.02	Rs user	Real	0.0000 ... 0.50000	p.u.	100000 = 1 p.u.
98.03	Rr user	Real	0.0000 ... 0.50000	p.u.	100000 = 1 p.u.
98.04	Lm user	Real	0.00000 ... 10.00000	p.u.	100000 = 1 p.u.
98.05	SigmaL user	Real	0.00000 ... 1.00000	p.u.	100000 = 1 p.u.
98.06	Ld user	Real	0.00000 ... 10.00000	p.u.	100000 = 1 p.u.
98.07	Lq user	Real	0.00000 ... 10.00000	p.u.	100000 = 1 p.u.
98.08	PM flux user	Real	0.00000 ... 2.00000	p.u.	100000 = 1 p.u.

No.	Name	Type	Range	Unit	FbEq32
98.09	Rs user SI	<i>Real</i>	0.00000 ... 100.00000	ohm	100000 = 1 p.u.
98.10	Rr user SI	<i>Real</i>	0.00000 ... 100.00000	ohm	100000 = 1 p.u.
98.11	Lm user SI	<i>Real</i>	0.00 ... 100000.00	mH	100 = 1 mH
98.12	SigmaL user SI	<i>Real</i>	0.00 ... 100000.00	mH	100 = 1 mH
98.13	Ld user SI	<i>Real</i>	0.00 ... 100000.00	mH	100 = 1 mH
98.14	Lq user SI	<i>Real</i>	0.00 ... 100000.00	mH	100 = 1 mH
98.15	Position offset user	<i>Real</i>	0...360	° electrical	1 = 1° electrical
<b>99 Motor data</b>					
99.03	Motor type	<i>List</i>	0...1	-	1 = 1
99.04	Motor ctrl mode	<i>List</i>	0...1	-	1 = 1
99.06	Motor nominal current	<i>Real</i>	0.0 ... 6400.0	A	10 = 1 A
99.07	Motor nominal voltage	<i>Real</i>	0.0 ... 800.0	V	10 = 1 V
99.08	Motor nominal frequency	<i>Real</i>	0.0 ... 500.0	Hz	10 = 1 Hz
99.09	Motor nominal speed	<i>Real</i>	0 ... 30000	rpm	1 = 1 rpm
99.10	Motor nominal power	<i>Real</i>	-10000.00 ... 10000.00	kW	100 = 1 kW
99.11	Motor nominal cosφ	<i>Real</i>	0.00 ... 1.00	-	100 = 1
99.12	Motor nominal torque	<i>Real</i>	0.00 ... 4294672329.296	N•m	1000 = 1 N•m
99.13	Identification run request	<i>List</i>	0...6	-	1 = 1
99.14	Identification run performed	<i>List</i>	0...6	-	1 = 1
99.15	Motor polepairs	<i>Real</i>	0...1000	-	1 = 1
99.16	Phase order	<i>List</i>	0...1	-	1 = 1
<b>200 Safety</b>					
This group contains parameters related to the optional FSO-xx safety functions module. For details on the parameters in this group, refer to the documentation of the FSO-xx module.					





# Fault tracing

---

## What this chapter contains

The chapter lists the warning and fault messages including possible causes and corrective actions. The causes of most warnings and faults can be identified and corrected using the information in this chapter. If not, an ABB service representative should be contacted.

Warnings and faults are listed below in separate tables. Each table is sorted by warning/fault code.

## Safety



**WARNING!** Only qualified electricians are allowed to service the drive. Read the *Safety instructions* on the first pages of the Hardware manual before working on the drive.

---

## Indications

Warnings and faults indicate an abnormal drive status. The codes and names of active warnings/faults are displayed on the control panel of the drive as well as the Drive composer PC tool. Only the codes of warnings/faults are available over fieldbus.

In addition to warnings and faults, there are pure events that are only recorded in the Event log of the drive. The codes of these events are included in the [Warning messages](#) table.

For some warnings and faults, the message text can be edited and instructions and contact information added. To edit these messages, choose Settings - Edit texts on the control panel.

---

## How to reset faults

After the cause of a fault has been corrected, the fault can be reset from a selectable source (see parameter [31.11 Fault reset selection](#)) such as the control panel, Drive composer PC tool, the digital inputs of the drive, or fieldbus. After the fault is removed, the drive can be restarted.

## Warning/fault history

### ■ Event log

When a warning or fault is detected, it is stored in the event log with a time stamp and other information. The event log can be accessed from the main Menu on the control panel. It can also be accessed (and reset) using the Drive composer PC tool.

### Auxiliary code

Some events generate an auxiliary code that often helps in pinpointing the problem. On the control panel, the auxiliary code is stored as part of the details of the event; in the Drive composer PC tool, the auxiliary code is shown in the event listing.

### ■ Parameters that contain warning/fault information

The codes of active warnings and faults (maximum five each), and five previously occurred warnings and faults are stored in the parameters of group [04 Warnings and faults](#) (page [86](#)).

---



## Warning messages

**Note:** The list also contains events that only appear in the Event log.

Code (hex)	Warning	Cause	What to do
A2A1	Current calibration	Current measurement calibration will occur at next start.	Informative warning.
A2B1	Overcurrent	Output current has exceeded internal fault limit.	<p>Check motor load.</p> <p>Check acceleration times in parameter group <a href="#">23 Speed reference ramp</a> (speed control), <a href="#">26 Torque reference chain</a> (torque control) or <a href="#">28 Frequency reference chain</a> (frequency control). Also check parameters <a href="#">46.01 Speed scaling</a>, <a href="#">46.01 Speed scaling</a> and <a href="#">46.03 Torque scaling</a>.</p> <p>Check motor and motor cable (including phasing and delta/star connection).</p> <p>Check that the start-up data in parameter group 99 corresponds to the motor rating plate.</p> <p>Check that there are no power factor correction capacitors or surge absorbers in motor cable.</p> <p>Check encoder cable (including phasing).</p>
A2B3	Earth leakage	Drive has detected load unbalance typically due to earth fault in motor or motor cable.	<p>Check there are no power factor correction capacitors or surge absorbers in motor cable.</p> <p>Check for an earth fault in motor or motor cables by measuring the insulation resistances of motor and motor cable.</p> <p>If no earth fault can be detected, contact your local ABB representative.</p>
A2B4	Short circuit	Short-circuit in motor cable(s) or motor.	<p>Check motor and motor cable.</p> <p>Check there are no power factor correction capacitors or surge absorbers in motor cable.</p>
A2BA	IGBT overload	Excessive IGBT junction to case temperature. This warning protects the IGBT(s) and can be activated by a short circuit in the motor cable.	Check motor cable.
A3A1	DC link overvoltage	Intermediate circuit DC voltage too high (when the drive is stopped).	<p>Check the supply voltage setting (parameter <a href="#">95.01 Supply voltage</a>). Note that the wrong setting of the parameter may cause the motor to rush uncontrollably, or the overloading of the brake chopper or resistor.</p> <p>Check the supply voltage.</p> <p>If the problem persists, contact your local ABB representative.</p>
A3A2	DC link undervoltage	Intermediate circuit DC voltage too low (when the drive is stopped).	
A3AA	DC not charged	The voltage of the intermediate DC circuit has not yet risen to operating level.	
A3C1	DC voltage difference	Difference in DC voltages between parallel-connected inverter modules.	Contact your local ABB representative.

## 314 Fault tracing

Code (hex)	Warning	Cause	What to do
A490	Incorrect temperature sensor setup	Sensor type mismatch or	Check the settings of supervision source parameters <a href="#">35.11</a> and <a href="#">35.21</a> against <a href="#">91.21</a> and <a href="#">91.24</a> .
		Faulty wiring between an encoder interface module and the temperature sensor.	Check the wiring of the sensor. The auxiliary code (see the event log) identifies the interface module. (0 = Module 1, 1 = Module 2).
A491	External temperature (Editable message text)	Measured temperature 1 or 2 has exceeded warning limit.	Check the values of parameters <a href="#">35.02 Measured temperature 1</a> and <a href="#">35.03 Measured temperature 2</a> . Check the cooling of the motor (or other equipment whose temperature is being measured). Check the warning limits for measured temperatures 1 and 2 in parameter group <a href="#">35 Motor thermal protection</a> .
A4A1	IGBT overtemperature	Estimated drive IGBT temperature is excessive.	Check ambient conditions. Check air flow and fan operation. Check heatsink fins for dust pick-up. Check motor power against drive power.
A4A9	Cooling	Drive module temperature is excessive.	Check ambient temperature. If it exceeds 40 °C (104 °F), ensure that load current does not exceed derated load capacity of drive. See appropriate <i>Hardware Manual</i> . Check drive module cooling air flow and fan operation. Check inside of cabinet and heatsink of drive module for dust pick-up. Clean whenever necessary.
A4B0	Excess temperature	Power unit module temperature is excessive.	Check ambient conditions. Check air flow and fan operation. Check heatsink fins for dust pick-up. Check motor power against drive power.
A4B1	Excess temperature difference	High temperature difference between the IGBTs of different phases.	Check the motor cabling. Check cooling of drive module(s).
A4F6	IGBT temperature	Drive IGBT temperature is excessive.	Check ambient conditions. Check air flow and fan operation. Check heatsink fins for dust pick-up. Check motor power against drive power.
A580	PU communication	Communication errors detected between the drive control unit and the power unit.	Check the connections between the drive control unit and the power unit.
A5A0	Safe torque off Programmable warning: <a href="#">31.22 STO indication run/stop</a>	Safe torque off function is active, i.e. safety circuit signal(s) connected to connector XSTO is lost.	Check safety circuit connections. For more information, see appropriate drive hardware manual and description of parameter <a href="#">31.22 STO indication run/stop</a> (page <a href="#">180</a> ).
A5EA	Measurement circuit temperature	Problem with internal temperature measurement of the drive.	Contact your local ABB representative.
A5EB	PU board powerfail	Power unit power supply failure.	Contact your local ABB representative.

Code (hex)	Warning	Cause	What to do
A5EC	PU communication internal	Communication errors detected between the drive control unit and the power unit.	Check the connections between the drive control unit and the power unit.
A5ED	Measurement circuit ADC	Measurement circuit fault.	Contact your local ABB representative.
A5EE	Measurement circuit DFF	Measurement circuit fault.	Contact your local ABB representative.
A5EF	PU state feedback	State feedback from output phases does not match control signals.	Contact your local ABB representative.
A5F0	Charging feedback	Charging feedback signal missing.	Check the feedback signal coming from the charging system.
A6A4	Motor nominal value	The motor parameters are set incorrectly.	Check the settings of the motor configuration parameters in group 99.
		The drive is not dimensioned correctly.	Check that the drive is sized correctly for the motor.
A6A5	No motor data	Parameters in group 99 have not been set.	Check that all the required parameters in group 99 have been set. <b>Note:</b> It is normal for this warning to appear during the start-up until the motor data is entered.
A6A6	Voltage category unselected	The supply voltage range has not been defined.	Define supply voltage range (parameter <a href="#">95.01 Supply voltage</a> ).
A6D1	FBA A parameter conflict	The drive does not have a functionality requested by PLC, or requested functionality has not been activated.	Check PLC programming. Check settings of parameter groups <a href="#">50 Fieldbus adapter (FBA)</a> and <a href="#">51 FBA A settings</a> .
A6E5	AI parametrization	The current/voltage jumper setting of an analog input does not correspond to parameter settings.	Adjust either the jumper setting (on the drive control unit) or parameter <a href="#">12.15/12.25</a> . <b>Note:</b> Control board reboot (either by cycling the power or through parameter <a href="#">96.08 Control board boot</a> ) is required to validate any changes in the jumper settings.
A780	Motor stall Programmable warning: <a href="#">31.24 Stall function</a>	Motor is operating in stall region because of e.g. excessive load or insufficient motor power.	Check motor load and drive ratings. Check fault function parameters.
A782	FEN temperature	Error in temperature measurement when temperature sensor (KTY or PTC) connected to encoder interface FEN-xx is used.	Check that parameter <a href="#">35.11 Supervision 1 source</a> / <a href="#">35.21 Supervision 2 source</a> setting corresponds to actual encoder interface installation.
		Error in temperature measurement when KTY sensor connected to encoder interface FEN-01 is used.	FEN-01 does not support temperature measurement with KTY sensor. Use PTC sensor or other encoder interface module.
A791	Brake resistor	Brake resistor broken or not connected.	Check that a brake resistor has been connected. Check the condition of the brake resistor.

Code (hex)	Warning	Cause	What to do
A793	BR excess temperature	Brake resistor temperature has exceeded warning limit defined by parameter <a href="#">43.12 Brake resistor warning limit</a> .	Stop drive. Let resistor cool down. Check resistor overload protection function settings (parameter group <a href="#">43 Brake chopper</a> ). Check warning limit setting, parameter <a href="#">43.12 Brake resistor warning limit</a> . Check that braking cycle meets allowed limits.
A794	BR data	Brake resistor data has not been given.	Check the resistor data settings (parameters <a href="#">43.08...43.10</a> ).
A79B	BC short circuit	Short circuit in brake chopper IGBT	Replace brake chopper. Ensure brake resistor is connected and not damaged.
A79C	BC IGBT excess temperature	Brake chopper IGBT temperature has exceeded internal warning limit.	Let chopper cool down. Check for excessive ambient temperature. Check for cooling fan failure. Check for obstructions in the air flow. Check the dimensioning and cooling of the cabinet. Check resistor overload protection function settings (parameters <a href="#">43.06...43.10</a> ). Check that braking cycle meets allowed limits. Check that drive supply AC voltage is not excessive.
A7A1	Mechanical brake closing failed Programmable warning: <a href="#">44.17 Brake fault function</a>	Status of mechanical brake acknowledgement is not as expected during brake close.	Check mechanical brake connection. Check mechanical brake settings in parameter group <a href="#">44 Mechanical brake control</a> . Check that acknowledgement signal matches actual status of brake.
A7A2	Mechanical brake opening failed Programmable warning: <a href="#">44.17 Brake fault function</a>	Status of mechanical brake acknowledgement is not as expected during brake open.	Check mechanical brake connection. Check mechanical brake settings in parameter group <a href="#">44 Mechanical brake control</a> . Check that acknowledgement signal matches actual status of brake.
A7A5	Mechanical brake opening not allowed Programmable warning: <a href="#">44.17 Brake fault function</a>	Open conditions of mechanical brake cannot be fulfilled (for example, brake has been prevented from opening by parameter <a href="#">44.11 Keep brake closed</a> ).	Check mechanical brake settings in parameter group <a href="#">44 Mechanical brake control</a> (especially <a href="#">44.11 Keep brake closed</a> ). Check that acknowledgement signal (if used) matches actual status of brake.
A7AA	FIO-11 AI parametrization	The hardware current/voltage setting of an analog input (on an FIO-11 I/O extension module) does not correspond to parameter settings.	Adjust either the setting on the FIO-11 module or parameter <a href="#">14.30/15.30/16.30</a> . (The hardware switch settings detected by the control program are shown in parameters <a href="#">14.29</a> , <a href="#">15.29</a> and <a href="#">16.29</a> .) <b>Note:</b> Control board reboot (either by cycling the power or through parameter <a href="#">96.08 Control board boot</a> ) is required to validate any changes in the jumper settings.

Code (hex)	Warning	Cause	What to do
A7AB	Extension I/O configuration failure	The I/O extension module types and locations specified by parameters do not match the detected configuration.	Check the event log for an auxiliary code. The code indicates which I/O extension module is affected. Check the type and location settings of the modules (parameters <a href="#">14.01</a> , <a href="#">14.02</a> , <a href="#">15.01</a> , <a href="#">15.02</a> , <a href="#">16.01</a> and <a href="#">16.02</a> ). Check that the modules are properly installed.
A7B0	Motor speed feedback Programmable warning: <a href="#">90.45 Motor feedback fault</a>	No motor speed feedback is received.	Check the settings of the parameters in groups <a href="#">90 Feedback selection</a> , <a href="#">91 Encoder module settings</a> , <a href="#">92 Encoder 1 configuration</a> and <a href="#">93 Encoder 2 configuration</a> . Check encoder installation.
A7C1	FBA A communication Programmable warning: <a href="#">50.02 FBA A comm loss func</a>	Cyclical communication between drive and fieldbus adapter module A or between PLC and fieldbus adapter module A is lost.	Check status of fieldbus communication. See user documentation of fieldbus interface. Check settings of parameter groups <a href="#">50 Fieldbus adapter (FBA)</a> , <a href="#">51 FBA A settings</a> , <a href="#">52 FBA A data in</a> and <a href="#">53 FBA A data out</a> . Check cable connections. Check if communication master is able to communicate.
A7CA	DDCS controller comm loss Programmable warning: <a href="#">60.59 DDCS controller comm loss action</a>	DDCS (fiber optic) communication between drive and external controller is lost.	Check status of controller. See user documentation of controller. Check settings of parameter group <a href="#">60 D2D and DDCS communication</a> . Check cable connections. If necessary, replace cables.
A7CB	MF comm loss Programmable warning: <a href="#">60.09 M/F comm loss function</a>	Master/follower communication is lost.	Check status of other drives on the master/follower link. Check settings of parameter group <a href="#">60 D2D and DDCS communication</a> . Check cable connections. If necessary, replace cables.
A7E1	Encoder 1	Encoder 1 error.	Check that the parameter settings in groups <a href="#">92 Encoder 1 configuration</a> are correct. <b>Note:</b> New settings will only take effect after parameter <a href="#">91.10 Encoder parameter refresh</a> is used or after the drive control unit is powered up the next time. Check the event log for an auxiliary code. See appropriate actions for each code below.
	Aux code: 410	Data read error	Contact your local ABB representative.
	Aux code: 411	Overspeed	
	Aux code: 412	Pulse overfrequency	
	Aux code: 413	Cable fault	Check the wiring of the encoder. See also parameters <a href="#">92.20 Encoder cable fault func</a> and <a href="#">92.21 Encoder cable fault mode</a> .

Code (hex)	Warning	Cause	What to do
	Aux code: 414	Resolver ID run fault	Contact your local ABB representative.
	Aux code: 415	Resolver SW version	
	Aux code: 416	Resolver speed scale	
	Aux code: 424	Data read error	
	Aux code: 425	Cable fault mode not supported	Current setting of <a href="#">92.21 Encoder cable fault mode</a> not supported by the FEN-xx module.
	Aux code: 514	Communication loss	Check the wiring of the encoder.
A7E2	Encoder 2	Encoder 2 has been activated by parameter but the encoder interface (FEN-xx) cannot be found.	Check that the parameter settings in groups <a href="#">93 Encoder 2 configuration</a> are correct. <b>Note:</b> New settings will only take effect after parameter <a href="#">91.10 Encoder parameter refresh</a> is used or after the drive control unit is powered up the next time. Check the event log for an auxiliary code. See appropriate actions for each code at warning <a href="#">A7E1 Encoder 1</a> .
A7EE	Panel loss Programmable warning: <a href="#">49.05 Communication loss action</a>	Control panel or PC tool selected as active control location for drive has ceased communicating.	Check PC tool or control panel connection. Check control panel connector. Disconnect and reconnect the control panel.
A880	Motor bearing warning Programmable warnings: <a href="#">33.14 On-time 1 warning select</a> <a href="#">33.24 On-time 2 warning select</a> <a href="#">33.55 Value counter 1 warning select</a> <a href="#">33.65 Value counter 2 warning selection</a>	Warning generated by an on-time timer or a value counter.	Check the event log for an auxiliary code. Check the source of the warning corresponding to the code: 0: <a href="#">33.13 On-time 1 source</a> 1: <a href="#">33.23 On-time 2 source</a> 4: <a href="#">33.53 Value counter 1 source</a> 5: <a href="#">33.63 Value counter 2 source</a> .
A881	Output relay warning	Warning generated by an edge counter. Programmable warnings: <a href="#">33.35 Edge counter 1 warning selection</a> <a href="#">33.45 Edge counter 2 warning selection</a>	Check the event log for an auxiliary code. Check the source of the warning corresponding to the code: 2: <a href="#">33.33 Edge counter 1 source</a> 3: <a href="#">33.43 Edge counter 2 source</a> .
A882	Motor starts warning		
A883	Power ups warning		
A884	Main contactor warning		
A885	DC charge warning		
A886	On-time 1 (Editable message text) Programmable warning: <a href="#">33.14 On-time 1 warning select</a>	Warning generated by on-time timer 1.	Check the source of the warning (parameter <a href="#">33.13 On-time 1 source</a> ).
A887	On-time 2 (Editable message text) Programmable warning: <a href="#">33.24 On-time 2 warning select</a>	Warning generated by on-time timer 2.	Check the source of the warning (parameter <a href="#">33.23 On-time 2 source</a> ).

Code (hex)	Warning	Cause	What to do
A888	Edge counter 1 (Editable message text) Programmable warning: <a href="#">33.35 Edge counter 1 warning selection</a>	Warning generated by edge counter 1.	Check the source of the warning (parameter <a href="#">33.33 Edge counter 1 source</a> ).
A889	Edge counter 2 (Editable message text) Programmable warning: <a href="#">33.45 Edge counter 2 warning selection</a>	Warning generated by edge counter 2.	Check the source of the warning (parameter <a href="#">33.43 Edge counter 2 source</a> ).
A88A	Value counter 1 (Editable message text) Programmable warning: <a href="#">33.55 Value counter 1 warning select</a>	Warning generated by value counter 1.	Check the source of the warning (parameter <a href="#">33.53 Value counter 1 source</a> ).
A88B	Value counter 2 (Editable message text) Programmable warning: <a href="#">33.65 Value counter 2 warning selection</a>	Warning generated by value counter 2.	Check the source of the warning (parameter <a href="#">33.63 Value counter 2 source</a> ).
A88C	Device clean warning	Warning generated by an on-time timer. Programmable warnings: <a href="#">33.14 On-time 1 warning select</a> <a href="#">33.24 On-time 2 warning select</a>	Check the event log for an auxiliary code. Check the source of the warning corresponding to the code: 0: <a href="#">33.13 On-time 1 source</a> 1: <a href="#">33.23 On-time 2 source</a> 10: <a href="#">05.04 Fan on-time counter</a> .
A88D	DC capacitor warning		
A88E	Cabinet fan warning		
A88F	Cooling fan warning		
A890	Additional cooling fan warning		
A8B0	Signal supervision (Editable message text) Programmable warning: <a href="#">32.06 Supervision 1 action</a> <a href="#">32.16 Supervision 2 action</a> <a href="#">32.26 Supervision 3 action</a>	Warning generated by a signal supervision function.	Check the source of the warning (parameter <a href="#">32.07</a> , <a href="#">32.17</a> or <a href="#">32.28</a> ).
A981	External warning 1 (Editable message text) Programmable warning: <a href="#">31.01 External event 1 source</a> <a href="#">31.02 External event 1 type</a>	Fault in external device 1.	Check the external device. Check setting of parameter <a href="#">31.01 External event 1 source</a> .
A982	External warning 2 (Editable message text) Programmable warning: <a href="#">31.03 External event 2 source</a> <a href="#">31.04 External event 2 type</a>	Fault in external device 2.	Check the external device. Check setting of parameter <a href="#">31.03 External event 2 source</a> .
A983	External warning 3 (Editable message text) Programmable warning: <a href="#">31.05 External event 3 source</a> <a href="#">31.06 External event 3 type</a>	Fault in external device 3.	Check the external device. Check setting of parameter <a href="#">31.05 External event 3 source</a> .

Code (hex)	Warning	Cause	What to do
A984	External warning 4 (Editable message text) Programmable warning: <a href="#">31.07 External event 4 source</a> <a href="#">31.08 External event 4 type</a>	Fault in external device 4.	Check the external device. Check setting of parameter <a href="#">31.07 External event 4 source</a> .
A985	External warning 5 (Editable message text) Programmable warning: <a href="#">31.09 External event 5 source</a> <a href="#">31.10 External event 5 type</a>	Fault in external device 5.	Check the external device. Check setting of parameter <a href="#">31.09 External event 5 source</a> .
AF8C	Process PID sleep mode	The drive is entering sleep mode.	Informative warning. See section <a href="#">Sleep function for process PID control</a> (page 46), and parameters <a href="#">40.41...40.48</a> .
AFAA	Autoreset	A fault is about to be autoreset.	Informative warning. See the settings in parameter group <a href="#">31 Fault functions</a> .
AFE1	Emergency stop (off2)	Drive has received an emergency stop (mode selection off2) command.	Check that it is safe to continue operation. Return emergency stop push button to normal position. Restart drive.
AFE2	Emergency stop (off1 or off3)	Drive has received an emergency stop (mode selection off1 or off3) command.	
AFEA	Enable start signal missing (Editable message text)	No enable start signal received.	Check the setting of (and the source selected by) parameter <a href="#">20.19 Enable start command</a> .
AFEB	Run enable missing	No run enable signal is received.	Check setting of parameter <a href="#">20.12 Run enable 1</a> . Switch signal on (e.g. in the fieldbus Control Word) or check wiring of selected source.
AFF6	Identification run	Motor ID run will occur at next start.	Informative warning.
AFF7	Autophasing	Autophasing will occur at next start.	Informative warning.
B5A0	STO event Programmable event: <a href="#">31.22 STO indication run/stop</a>	Safe torque off function is active, i.e. safety circuit signal(s) connected to connector XSTO is lost.	Check safety circuit connections. For more information, see appropriate drive hardware manual and description of parameter <a href="#">31.22 STO indication run/stop</a> (page 180).



## Fault messages

Code (hex)	Fault	Cause	What to do
2281	Calibration	Measured offset of output phase current measurement or difference between output phase U2 and W2 current measurement is too great (the values are updated during current calibration).	Try performing the current calibration again (select <i>Current measurement calibration</i> at parameter 99.13). If the fault persists, contact your local ABB representative.
2310	Overcurrent	Output current has exceeded internal fault limit.	<p>Check motor load.</p> <p>Check acceleration times in parameter group 23 <i>Speed reference ramp</i> (speed control), 26 <i>Torque reference chain</i> (torque control) or 28 <i>Frequency reference chain</i> (frequency control). Also check parameters 46.01 <i>Speed scaling</i>, 46.01 <i>Speed scaling</i> and 46.03 <i>Torque scaling</i>.</p> <p>Check motor and motor cable (including phasing and delta/star connection).</p> <p>Check that the start-up data in parameter group 99 corresponds to the motor rating plate.</p> <p>Check that there are no power factor correction capacitors or surge absorbers in motor cable.</p> <p>Check encoder cable (including phasing).</p>
2330	Earth leakage Programmable fault: 31.20 <i>Earth fault</i>	Drive has detected load unbalance typically due to earth fault in motor or motor cable.	<p>Check there are no power factor correction capacitors or surge absorbers in motor cable.</p> <p>Check that there is no earth fault in motor or motor cables:</p> <p>Measure insulation resistances of motor and motor cable.</p> <p>If no earth fault can be detected, contact your local ABB representative.</p>
2340	Short circuit	Short-circuit in motor cable(s) or motor	<p>Check motor and motor cable.</p> <p>Check there are no power factor correction capacitors or surge absorbers in motor cable.</p>
2381	IGBT overload	Excessive IGBT junction to case temperature. This fault protects the IGBT(s) and can be activated by a short circuit in the motor cable.	Check motor cable.
3130	Input phase loss Programmable fault: 31.21 <i>Supply phase loss</i>	Intermediate circuit DC voltage is oscillating due to missing input power line phase or blown fuse.	<p>Check input power line fuses.</p> <p>Check for input power supply imbalance.</p>
3180	Charge relay lost	No acknowledgement received from charge relay.	Contact your local ABB representative.
3181	Cross connection Programmable fault: 31.23 <i>Cross connection</i>	Incorrect input power and motor cable connection (i.e. input power cable is connected to drive motor connection).	Check input power connections.

## 322 Fault tracing

Code (hex)	Fault	Cause	What to do
3210	DC link overvoltage	Excessive intermediate circuit DC voltage.	Check that overvoltage control is on (parameter <a href="#">30.30 Overvoltage control</a> ). Check that the supply voltage matches the nominal input voltage of the drive. Check the supply line for static or transient overvoltage. Check brake chopper and resistor (if present). Check deceleration time. Use coast-to-stop function (if applicable). Retrofit drive with brake chopper and brake resistor.
3220	DC link undervoltage	Intermediate circuit DC voltage is not sufficient because of a missing supply phase, blown fuse or fault in the rectifier bridge.	Check supply cabling, fuses and switchgear.
3280	Standby timeout	Automatic restart failed (see section <a href="#">Automatic restart</a> on page <a href="#">54</a> ).	Check the condition of the supply (voltage, cabling, fuses, switchgear).
3291	DC voltage difference	Difference in DC voltages between parallel-connected inverter modules.	Contact your local ABB representative.
3381	Output phase loss Programmable fault: <a href="#">31.19 Motor phase loss</a>	Motor circuit fault due to missing motor connection (all three phases are not connected).	Connect motor cable.
3385	Autophasing	Autophasing routine (see section <a href="#">Autophasing</a> on page <a href="#">41</a> ) has failed.	Try other autophasing modes (see parameter <a href="#">21.13 Autophasing mode</a> ) if possible.
4210	IGBT overtemperature	Estimated drive IGBT temperature is excessive.	Check ambient conditions. Check air flow and fan operation. Check heatsink fins for dust pick-up. Check motor power against drive power.
4290	Cooling	Drive module temperature is excessive.	Check ambient temperature. If it exceeds 40 °C (104 °F), ensure that load current does not exceed derated load capacity of drive. See appropriate <i>Hardware Manual</i> . Check drive module cooling air flow and fan operation. Check inside of cabinet and heatsink of drive module for dust pick-up. Clean whenever necessary.
4310	Excess temperature	Power unit module temperature is excessive.	Check ambient conditions. Check air flow and fan operation. Check heatsink fins for dust pick-up. Check motor power against drive power.
4380	Excess temperature difference	High temperature difference between the IGBTs of different phases.	Check the motor cabling. Check cooling of drive module(s).

Code (hex)	Fault	Cause	What to do
42F1	IGBT temperature	Drive IGBT temperature is excessive.	Check ambient conditions. Check air flow and fan operation. Check heatsink fins for dust pick-up. Check motor power against drive power.
4981	External temperature (Editable message text)	Measured temperature 1 or 2 has exceeded fault limit.	Check the values of parameters <a href="#">35.02 Measured temperature 1</a> and <a href="#">35.03 Measured temperature 2</a> . Check the cooling of the motor (or other equipment whose temperature is being measured). Check the fault limits for measured temperatures 1 and 2 in parameter group <a href="#">35 Motor thermal protection</a> .
5080	Fan	Cooling fan stuck or disconnected.	Check fan operation and connection. Replace fan if faulty.
5090	STO hardware failure	Safe torque off hardware failure.	Contact your local ABB representative.
5091	Safe torque off Programmable fault: <a href="#">31.22 STO indication run/stop</a>	Safe torque off function is active, i.e. safety circuit signal(s) connected to connector XSTO is broken during start or run.	Check safe torque off circuit connections. For more information, see appropriate drive hardware manual and description of parameter <a href="#">31.22 STO indication run/stop</a> (page 180).
5092	PU logic error	Power unit memory has cleared.	Contact your local ABB representative.
5093	Rating ID mismatch	The hardware of the drive does not match the information stored in the memory unit. This may occur eg. after a firmware update or memory unit replacement.	Cycle the power to the drive.
5681	PU communication	Communication errors detected between the drive control unit and the power unit.	Check the connection between the drive control unit and the power unit.
5682	Power unit lost	Connection between the drive control unit and the power unit is lost.	Check the connection between the control unit and the power unit.
5690	PU communication internal	Internal communication error.	Contact your local ABB representative.
5691	Measurement circuit ADC	Measurement circuit fault.	Contact your local ABB representative.
5692	PU board powerfail	Power unit power supply failure.	Contact your local ABB representative.
5693	Measurement circuit DFF	Measurement circuit fault.	Contact your local ABB representative.
5694	PU communication configuration	Version check cannot find a matching power unit FPGA logic.	Update the FPGA logic of the power unit. Contact your local ABB representative.
5696	PU state feedback	State feedback from output phases does not match control signals.	Contact your local ABB representative.
5697	Charging feedback	Charging feedback signal missing.	Check the feedback signal coming from the charging system.

## 324 Fault tracing

Code (hex)	Fault	Cause	What to do
5698	Unknown power unit fault	Unidentified power unit logic fault.	Check power unit logic and firmware compatibility. Contact your local ABB representative.
6180	Internal SW error	Internal error.	Contact your local ABB representative. Quote the auxiliary code (check the event details in the event log).
6181	FPGA version incompatible	Firmware and FPGA versions are incompatible.	Update power unit FPGA logic or firmware (whichever is older). Contact your local ABB representative.
6306	FBA A mapping file	Fieldbus adapter A mapping file read error.	Contact your local ABB representative.
6481	Task overload	Internal fault. <b>Note:</b> This fault cannot be reset.	Contact your local ABB representative.
6487	Stack overflow	Internal fault. <b>Note:</b> This fault cannot be reset.	Contact your local ABB representative.
64A1	Internal file load	File read error. <b>Note:</b> This fault cannot be reset.	Contact your local ABB representative.
64A2	Internal record load	Internal record load error.	Contact your local ABB representative.
64A3	Application loading	Application file incompatible or corrupted. <b>Note:</b> This fault cannot be reset.	Contact your local ABB representative.
64B2	User set fault	Loading of user parameter set failed because <ul style="list-style-type: none"> <li>• requested set does not exist</li> <li>• set is not compatible with control program</li> <li>• drive was switched off during loading.</li> </ul>	Ensure that a valid user parameter set exists. Reload.
64E1	Kernel overload	Operating system error. <b>Note:</b> This fault cannot be reset.	Contact your local ABB representative.
6581	Parameter system	Parameter load or save failed.	Try forcing a save using parameter <a href="#">96.07 Parameter save</a> . Retry.
65A1	FBA A parameter conflict	The drive does not have a functionality requested by PLC, or requested functionality has not been activated.	Check PLC programming. Check settings of parameter groups <a href="#">50 Fieldbus adapter (FBA)</a> and <a href="#">51 FBA A settings</a> .
6881	Text data overflow	Internal fault.	Reset the fault. Contact your local ABB representative if the fault persists.
6882	Text 32-bit table overflow	Internal fault.	Reset the fault. Contact your local ABB representative if the fault persists.
6883	Text 64-bit table overflow	Internal fault.	Reset the fault. Contact your local ABB representative if the fault persists.
6885	Text file overflow	Internal fault.	Reset the fault. Contact your local ABB representative if the fault persists.

Code (hex)	Fault	Cause	What to do
7080	Option module comm loss	Communication between drive and option module (FEN-xx and/or FIO-xx) is lost.	Check that the option modules are properly seated in their slots. Check that the option modules or slot connectors are not damaged. To pinpoint the problem, try installing the modules into different slots.
7081	Panel port communication Programmable fault: <a href="#">49.05 Communication loss action</a>	Control panel or PC tool selected as active control location for drive has ceased communicating.	Check PC tool or control panel connection. Check control panel connector. Disconnect and reconnect the control panel.
7082	Extension I/O type mismatch	The I/O extension module types specified by parameters do not match the detected configuration.	Check the event log for an auxiliary code. The code indicates which I/O extension module is affected. Check the type and location settings of the modules (parameters <a href="#">14.01</a> , <a href="#">14.02</a> , <a href="#">15.01</a> , <a href="#">15.02</a> , <a href="#">16.01</a> and <a href="#">16.02</a> ). Check that the modules are properly installed.
7121	Motor stall Programmable fault: <a href="#">31.24 Stall function</a>	Motor is operating in stall region because of e.g. excessive load or insufficient motor power.	Check motor load and drive ratings. Check fault function parameters.
7181	Brake resistor	Brake resistor broken or not connected.	Check that a brake resistor has been connected. Check the condition of the brake resistor. Check the dimensioning of the brake resistor.
7183	BR excess temperature	Brake resistor temperature has exceeded fault limit defined by parameter <a href="#">43.11 Brake resistor fault limit</a> .	Stop drive. Let resistor cool down. Check resistor overload protection function settings (parameter group <a href="#">43 Brake chopper</a> ). Check fault limit setting, parameter <a href="#">43.11 Brake resistor fault limit</a> . Check that braking cycle meets allowed limits.
7184	Brake resistor wiring	Brake resistor short circuit or brake chopper control fault.	Check brake chopper and brake resistor connection. Ensure brake resistor is not damaged.
7191	BC short circuit	Short circuit in brake chopper IGBT.	Ensure brake resistor is connected and not damaged. Check the electrical specifications of the brake resistor against the <i>Hardware manual</i> . Replace brake chopper (if replaceable).

Code (hex)	Fault	Cause	What to do
7192	BC IGBT excess temperature	Brake chopper IGBT temperature has exceeded internal fault limit.	Let chopper cool down. Check for excessive ambient temperature. Check for cooling fan failure. Check for obstructions in the air flow. Check the dimensioning and cooling of the cabinet. Check resistor overload protection function settings (parameter group <a href="#">43 Brake chopper</a> ). Check that braking cycle meets allowed limits. Check that drive supply AC voltage is not excessive.
71A2	Mechanical brake closing failed Programmable fault: <a href="#">44.17 Brake fault function</a>	Mechanical brake control fault. Activated eg. if brake acknowledgement is not as expected during brake closing.	Check mechanical brake connection. Check mechanical brake settings in parameter group <a href="#">44 Mechanical brake control</a> . Check that acknowledgement signal matches actual status of brake.
71A3	Mechanical brake opening failed Programmable fault: <a href="#">44.17 Brake fault function</a>	Mechanical brake control fault. Activated eg. if brake acknowledgement is not as expected during brake opening.	Check mechanical brake connection. Check mechanical brake settings in parameter group <a href="#">44 Mechanical brake control</a> . Check that acknowledgement signal matches actual status of brake.
71A5	Mechanical brake opening not allowed Programmable fault: <a href="#">44.17 Brake fault function</a>	Open conditions of mechanical brake cannot be fulfilled (for example, brake has been prevented from opening by parameter <a href="#">44.11 Keep brake closed</a> ).	Check mechanical brake settings in parameter group <a href="#">44 Mechanical brake control</a> (especially <a href="#">44.11 Keep brake closed</a> ). Check that acknowledgement signal (if used) matches actual status of brake.
7301	Motor speed feedback Programmable fault: <a href="#">90.45 Motor feedback fault</a>	No motor speed feedback received.	Check the setting of parameter <a href="#">90.41 Motor feedback selection</a> , and the actual source selected.
7310	Overspeed	Motor is turning faster than highest allowed speed due to incorrectly set minimum/maximum speed, insufficient braking torque or changes in load when using torque reference.	Check minimum/maximum speed settings, parameters <a href="#">30.11 Minimum speed</a> and <a href="#">30.12 Maximum speed</a> . Check adequacy of motor braking torque. Check applicability of torque control. Check need for brake chopper and resistor(s).
7380	Encoder internal	Internal fault.	Contact your local ABB representative.

Code (hex)	Fault	Cause	What to do
7381	Encoder 1	Encoder 1 feedback fault.	<p>If fault appears during first start-up before encoder feedback is used:</p> <ul style="list-style-type: none"> <li>- Check cable between encoder and encoder interface module (FEN-xx) and order of connector signal wires at both ends of cable.</li> </ul> <p>If fault appears after encoder feedback has already been used or during drive :</p> <ul style="list-style-type: none"> <li>- Check that encoder connection wiring or encoder is not damaged.</li> <li>- Check that encoder interface module (FEN-xx) connection or module is not damaged.</li> <li>- Check earthings (when disturbances are detected in communication between encoder interface module and encoder).</li> </ul> <p>For more information on encoders, see parameter groups <a href="#">90 Feedback selection</a>, <a href="#">91 Encoder module settings</a>, <a href="#">92 Encoder 1 configuration</a> and <a href="#">93 Encoder 2 configuration</a>.</p> <p>Check the event log for an auxiliary code. See appropriate actions for each code at warning <a href="#">A7E1 Encoder 1</a> (page <a href="#">317</a>).</p>
7391	Encoder 2	Encoder 2 feedback fault.	See fault <a href="#">7381</a> .
73A0	Speed feedback configuration	Speed feedback configuration incorrect, eg. an encoder that is not present is selected as the feedback interface.	Check the feedback source selection parameters in group <a href="#">90 Feedback selection</a> . In case the source is an encoder interface, check parameter settings in groups <a href="#">91 Encoder module settings</a> , <a href="#">92 Encoder 1 configuration</a> and <a href="#">93 Encoder 2 configuration</a> .
73A1	Load feedback	No load feedback received.	Check the setting of parameter <a href="#">90.51 Load feedback selection</a> , and the actual source selected. In case the source is an encoder interface, check parameter settings in groups <a href="#">91 Encoder module settings</a> , <a href="#">92 Encoder 1 configuration</a> and <a href="#">93 Encoder 2 configuration</a> .
7510	FBA A communication Programmable fault: <a href="#">50.02 FBA A comm loss func</a>	Cyclical communication between drive and fieldbus adapter module A or between PLC and fieldbus adapter module A is lost.	<p>Check status of fieldbus communication. See user documentation of fieldbus interface.</p> <p>Check settings of parameter groups <a href="#">50 Fieldbus adapter (FBA)</a>, <a href="#">51 FBA A settings</a>, <a href="#">52 FBA A data in</a> and <a href="#">53 FBA A data out</a>.</p> <p>Check cable connections.</p> <p>Check if communication master is able to communicate.</p>
7581	DDCS controller comm loss Programmable fault: <a href="#">60.59 DDCS controller comm loss action</a>	DDCS (fiber optic) communication between drive and external controller is lost.	<p>Check status of controller. See user documentation of controller.</p> <p>Check settings of parameter group <a href="#">60 D2D and DDCS communication</a>.</p> <p>Check cable connections. If necessary, replace cables.</p>

## 328 Fault tracing

Code (hex)	Fault	Cause	What to do
7582	MF comm loss Programmable fault: <a href="#">60.09 M/F comm loss function</a>	Master/follower communication is lost.	Check status of other drives on the master/follower link. Check settings of parameter group <a href="#">60 D2D and DDCS communication</a> . Check cable connections. If necessary, replace cables.
80B0	Signal supervision (Editable message text) Programmable fault: <a href="#">32.06 Supervision 1 action</a> <a href="#">32.16 Supervision 2 action</a> <a href="#">32.26 Supervision 3 action</a>	Fault generated by a signal supervision function.	Check the source of the fault (parameter <a href="#">32.07</a> , <a href="#">32.17</a> or <a href="#">32.28</a> ).
9081	External fault 1 (Editable message text) Programmable fault: <a href="#">31.01 External event 1 source</a> <a href="#">31.02 External event 1 type</a>	Fault in external device 1.	Check the external device. Check setting of parameter <a href="#">31.01 External event 1 source</a> .
9082	External fault 2 (Editable message text) Programmable fault: <a href="#">31.03 External event 2 source</a> <a href="#">31.04 External event 2 type</a>	Fault in external device 2.	Check the external device. Check setting of parameter <a href="#">31.03 External event 2 source</a> .
9083	External fault 3 (Editable message text) Programmable fault: <a href="#">31.05 External event 3 source</a> <a href="#">31.06 External event 3 type</a>	Fault in external device 3.	Check the external device. Check setting of parameter <a href="#">31.05 External event 3 source</a> .
9084	External fault 4 (Editable message text) Programmable fault: <a href="#">31.07 External event 4 source</a> <a href="#">31.08 External event 4 type</a>	Fault in external device 4.	Check the external device. Check setting of parameter <a href="#">31.07 External event 4 source</a> .
9085	External fault 5 (Editable message text) Programmable fault: <a href="#">31.09 External event 5 source</a> <a href="#">31.10 External event 5 type</a>	Fault in external device 5.	Check the external device. Check setting of parameter <a href="#">31.09 External event 5 source</a> .
FA81	Safe torque off 1	Safe torque off function is active, ie. STO circuit 1 is broken.	Check safety circuit connections. For more information, see appropriate drive hardware manual and description of parameter <a href="#">31.22 STO indication run/stop</a> (page <a href="#">180</a> ).
FA82	Safe torque off 2	Safe torque off function is active, ie. STO circuit 2 is broken.	



Code (hex)	Fault	Cause	What to do
FF61	ID run	Motor ID run was not completed successfully.	<p>Check the nominal motor values in parameter group <a href="#">99 Motor data</a>.</p> <p>Check that no external control system is connected to the drive.</p> <p>Cycle the power to the drive (and its control unit, if powered separately).</p> <p>Check that no operation limits prevent the completion of the ID run. Restore parameters to default settings and try again.</p> <p>Check that the motor shaft is not locked.</p>
FF81	FB A force trip	A fault trip command has been received through fieldbus adapter A.	Check the fault information provided by the PLC.
FF82	FB B force trip	A fault trip command has been received through fieldbus adapter B.	Check the fault information provided by the PLC.
FF8E	EFB force trip	A fault trip command has been received through the embedded fieldbus interface.	Check the fault information provided by the PLC.





# Fieldbus control through the embedded fieldbus interface (EFB)

---

This feature is not supported by the current firmware version.

---





# Fieldbus control through a fieldbus adapter

---

## What this chapter contains

This chapter describes how the drive can be controlled by external devices over a communication network (fieldbus) through an optional fieldbus adapter module.

The fieldbus control interface of the drive is described first, followed by a configuration example.

---

## System overview

The drive can be connected to an external control system through a serial communication link using a fieldbus adapter. The fieldbus adapter can be installed into any free drive slot.

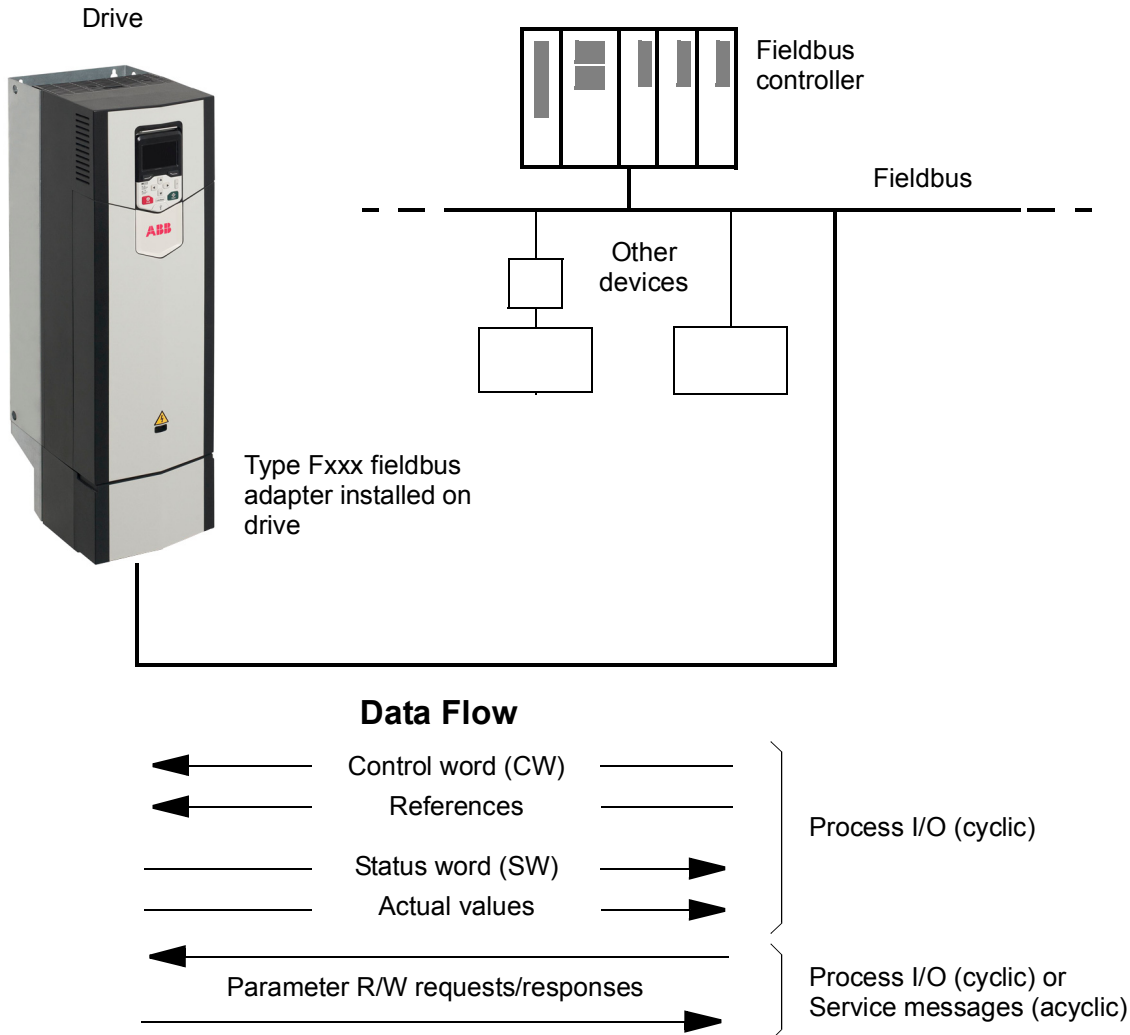

The drive can be set to receive all of its control information through the fieldbus interface, or the control can be distributed between the fieldbus interface and other available sources such as digital and analog inputs.

Fieldbus adapters are available for various serial communication systems and protocols, for example

- PROFIBUS DP (FPBA-01 adapter)
- CANopen (FCAN-01 adapter)
- DeviceNet (FDNA-01 adapter)
- EtherNet/IP™ (FENA-11 adapter)
- EtherCAT® (FECA-01 adapter).

## Basics of the fieldbus control interface

The cyclic communication between a fieldbus system and the drive consists of 16/32-bit input and output data words. The drive supports at the maximum the use of 12 data words (16 bits) in each direction.

Data transmitted from the drive to the fieldbus controller is defined by parameters [52.01 FBA data in1](#) ... [52.12 FBA data in12](#). The data transmitted from the fieldbus controller to the drive is defined by parameters [53.01 FBA data out1](#) ... [53.12 FBA data out12](#).

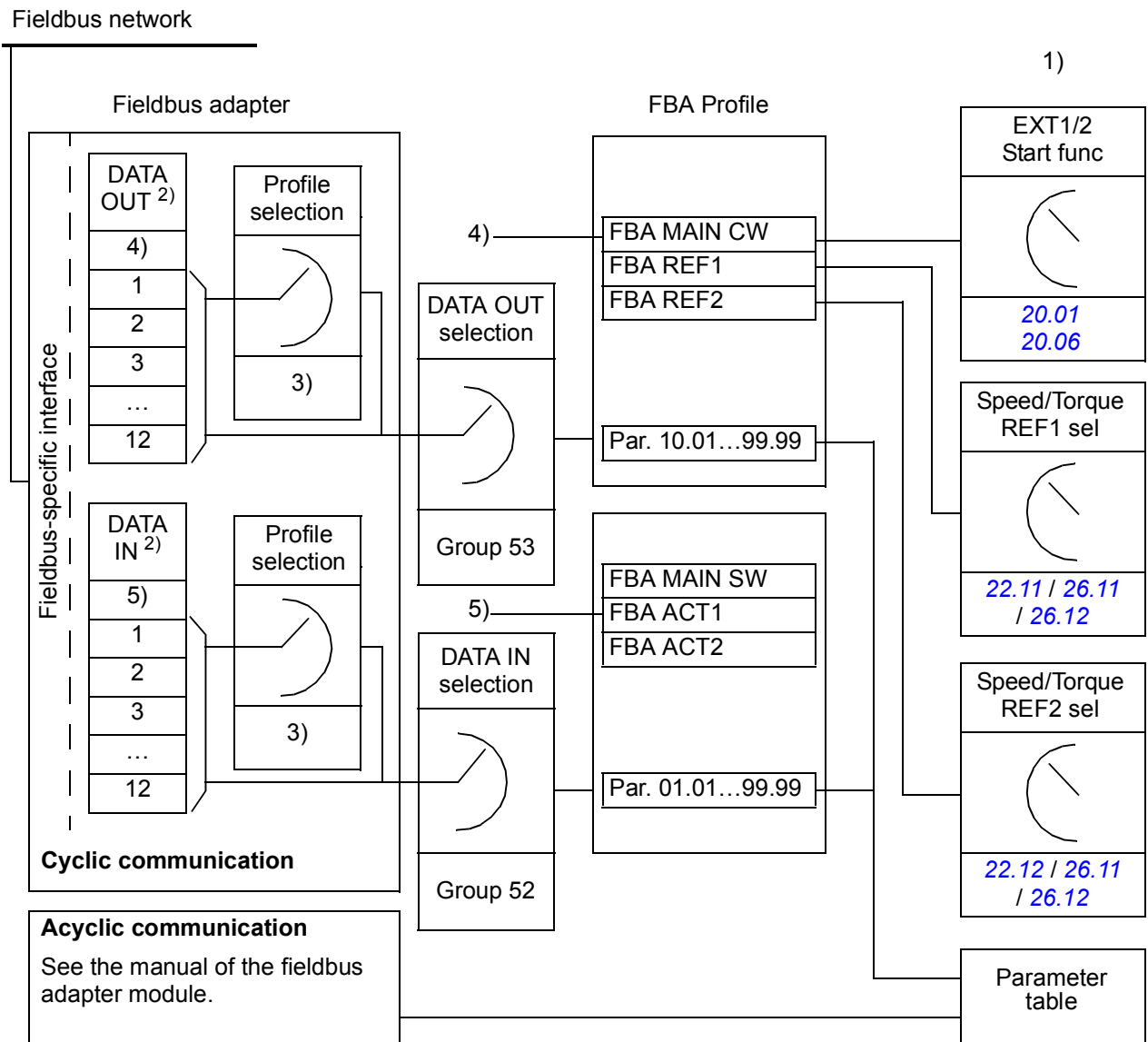

- 1) See also other parameters which can be controlled from fieldbus.
- 2) The maximum number of used data words is protocol-dependent.
- 3) Profile/instance selection parameters. Fieldbus module specific parameters. For more information, see the *User's Manual* of the appropriate fieldbus adapter module.
- 4) With DeviceNet, the control part is transmitted directly.
- 5) With DeviceNet, the actual value part is transmitted directly.

## ■ **Control word and Status word**

The Control word is the principal means for controlling the drive from a fieldbus system. It is sent by the fieldbus master station to the drive through the adapter module. The drive switches between its states according to the bit-coded instructions on the Control word, and returns status information to the master in the Status word.

The contents of the Control word and the Status word are detailed on pages [339](#) and [340](#) respectively. The drive states are presented in the state diagram (page [341](#)).

If parameter [50.12 FBA A debug enable](#) is set to *Enable*, the Control word received from the fieldbus is shown by parameter [50.13 FBA A control word](#), and the Status word transmitted to the fieldbus network by [50.16 FBA A status word](#).

---



## ■ References

References are 16-bit words containing a sign bit and a 15-bit integer. A negative reference (indicating reversed direction of rotation) is formed by calculating the two's complement from the corresponding positive reference.

ABB drives can receive control information from multiple sources including analog and digital inputs, the drive control panel and a fieldbus adapter module. In order to have the drive controlled through the fieldbus, the module must be defined as the source for control information, e.g. Reference.

If parameter [50.12 FBA A debug enable](#) is set to *Enable*, the references received from the fieldbus are displayed by [50.14 FBA A reference 1](#) and [50.15 FBA A reference 2](#).

### Scaling of references

The references are scaled as shown below. The values REFx MIN and REFx MAX are set by parameters [46.01...46.04](#); which scaling is in use depends on the setting of [50.04 FBA A ref1 type](#) and [50.05 FBA A ref2 type](#).

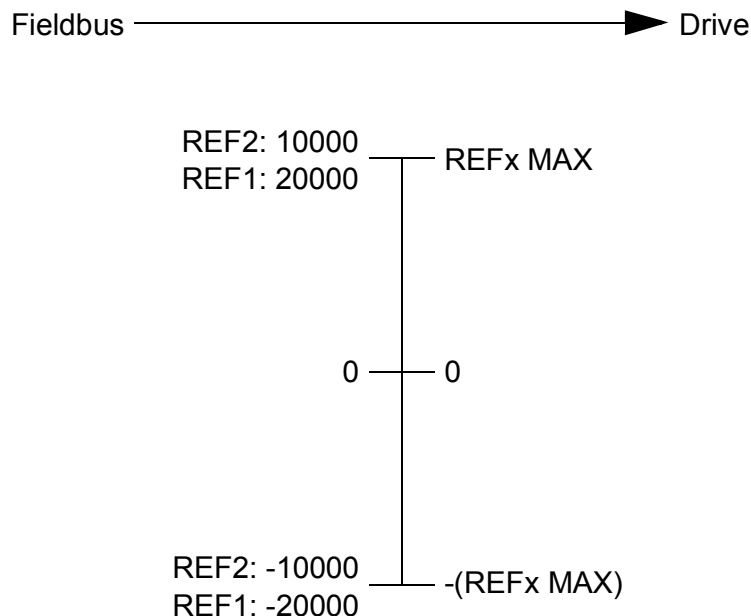

The scaled references are shown by parameters [03.05 FB A reference 1](#) and [03.06 FB A reference 2](#).

## ■ Actual values

Actual values are 16-bit words containing information on the operation of the drive. The types of the monitored signals are selected by parameters [50.07 FBA A actual 1 type](#) and [50.08 FBA A actual 2 type](#).

If parameter [50.12 FBA A debug enable](#) is set to *Enable*, the actual values sent to the fieldbus are displayed by [50.17 FBA A actual value 1](#) and [50.18 FBA A actual value 2](#).

## Scaling of actual values

The actual values are scaled as shown below. The values REFx MIN and REFx MAX are set by parameters [46.01...46.04](#); which scaling is in use depends on the setting of parameters [50.04](#) and [50.05](#).

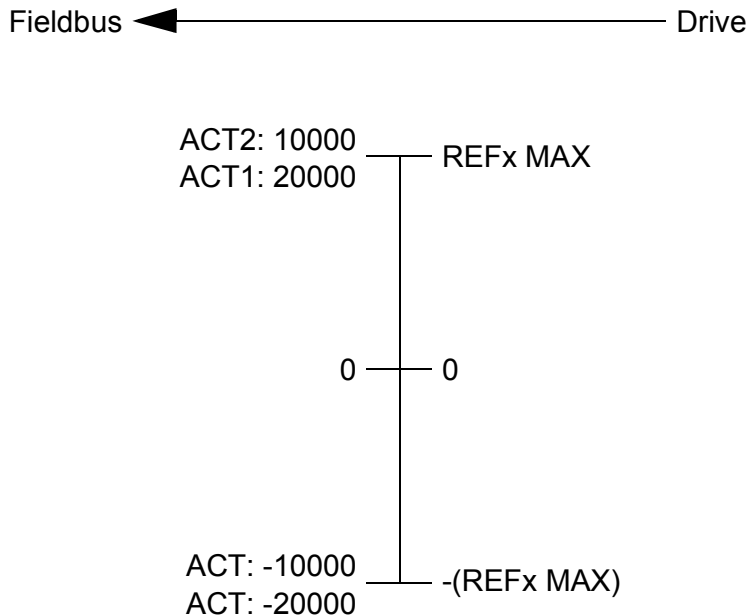

## ■ Contents of the fieldbus Control word

The upper case boldface text refers to the states shown in the state diagram (page 341).

Bit	Name	Value	STATE/Description
0	Off1 control	1	Proceed to <b>READY TO OPERATE</b> .
		0	Stop along currently active deceleration ramp. Proceed to <b>OFF1 ACTIVE</b> ; proceed to <b>READY TO SWITCH ON</b> unless other interlocks (OFF2, OFF3) are active.
1	Off2 control	1	Continue operation (OFF2 inactive).
		0	Emergency OFF, coast to a stop. Proceed to <b>OFF2 ACTIVE</b> , proceed to <b>SWITCH-ON INHIBITED</b> .
2	Off3 control	1	Continue operation (OFF3 inactive).
		0	Emergency stop, stop within time defined by drive parameter. Proceed to <b>OFF3 ACTIVE</b> ; proceed to <b>SWITCH-ON INHIBITED</b> .  <b>WARNING:</b> Ensure motor and driven machine can be stopped using this stop mode.
3	Run	1	Proceed to <b>OPERATION ENABLED</b> . <b>Note:</b> Run enable signal must be active; see drive documentation. If the drive is set to receive the Run enable signal from the fieldbus, this bit activates the signal.
		0	Inhibit operation. Proceed to <b>OPERATION INHIBITED</b> .
4	Ramp out zero	1	Normal operation. Proceed to <b>RAMP FUNCTION GENERATOR: OUTPUT ENABLED</b> .
		0	Force Ramp function generator output to zero. The drive will immediately decelerate to zero speed (observing the torque limits).
5	Ramp hold	1	Enable ramp function. Proceed to <b>RAMP FUNCTION GENERATOR: ACCELERATOR ENABLED</b> .
		0	Halt ramping (Ramp Function Generator output held).
6	Ramp in zero	1	Normal operation. Proceed to <b>OPERATING</b> . <b>Note:</b> This bit is effective only if the fieldbus interface is set as the source for this signal by drive parameters.
		0	Force Ramp function generator input to zero.
7	Reset	0=>1	Fault reset if an active fault exists. Proceed to <b>SWITCH-ON INHIBITED</b> . <b>Note:</b> This bit is effective only if the fieldbus interface is set as the source for this signal by drive parameters.
		0	Continue normal operation.
8	Inching 1	1	Accelerate to inching (jogging) setpoint 1. <b>Note:</b> Inching does not follow the acceleration/deceleration ramps defined for jogging.
		0	Inching (jogging) 1 disabled.
9	Inching 2	1	Accelerate to inching (jogging) setpoint 2. <b>Note:</b> Inching does not follow the acceleration/deceleration ramps defined for jogging.
		0	Inching (jogging) 2 disabled.
10	Remote cmd	1	Fieldbus control enabled.
		0	Control word and reference not getting through to the drive, except for bits OFF1, OFF2 and OFF3.
11	Ext ctrl loc	1	Select External Control Location EXT2. Effective if control location parameterized to be selected from fieldbus.
		0	Select External Control Location EXT1. Effective if control location parameterized to be selected from fieldbus.
12 to 15	Reserved.		

## ■ Contents of the fieldbus Status word

The upper case boldface text refers to the states shown in the state diagram (page [341](#)).

Bit	Name	Value	STATE/Description
0	Ready to switch ON	1	<b>READY TO SWITCH ON.</b>
		0	<b>NOT READY TO SWITCH ON.</b>
1	Ready run	1	<b>READY TO OPERATE.</b>
		0	<b>OFF1 ACTIVE.</b>
2	Ready ref	1	<b>OPERATION ENABLED.</b>
		0	<b>OPERATION INHIBITED.</b>
3	Tripped	1	<b>FAULT.</b>
		0	No fault.
4	Off 2 inactive	1	OFF2 inactive.
		0	<b>OFF2 ACTIVE.</b>
5	Off 3 inactive	1	OFF3 inactive.
		0	<b>OFF3 ACTIVE.</b>
6	Switch-on inhibited	1	<b>SWITCH-ON INHIBITED.</b>
		0	–
7	Warning	1	Warning active.
		0	No warning active.
8	At setpoint	1	<b>OPERATING.</b> Actual value equals reference = is within tolerance limits, i.e. in speed control, speed error is 10% max. of nominal motor speed.
		0	Actual value differs from reference = is outside tolerance limits.
9	Remote	1	Drive control location: REMOTE (EXT1 or EXT2).
		0	Drive control location: LOCAL.
10	Above limit	1	Actual speed, frequency or torque equals or exceeds supervision limit. Valid in both directions of rotation. The supervision limits are defined by parameters <a href="#">46.31</a> ... <a href="#">46.33</a> .
		0	Actual speed, frequency or torque within supervision limit.
11	User bit 0	-	See parameter <a href="#">06.30</a> <i>User bit 0 selection</i> .
12	User bit 1	-	See parameter <a href="#">06.31</a> <i>User bit 1 selection</i> .
13	User bit 2	-	See parameter <a href="#">06.32</a> <i>User bit 2 selection</i> .
14	User bit 3	-	See parameter <a href="#">06.33</a> <i>User bit 3 selection</i> .
15	Reserved		



## Setting up the drive for fieldbus control

Before configuring the drive for fieldbus control, the adapter module must be mechanically and electrically installed according to the instructions given in the *User's manual* of the appropriate fieldbus adapter module.

1. Power up the drive.
  2. Enable the communication between the drive and the fieldbus adapter module by setting parameter [50.01 FBA A enable](#) to *Enable*.
  3. With [50.02 FBA A comm loss func](#), select how the drive should react to a fieldbus communication break.  
**Note:** This function monitors both the communication between the fieldbus master and the adapter module and the communication between the adapter module and the drive.
  4. With [50.03 FBA A comm loss timeout](#), define the time between communication break detection and the selected action.
  5. Select application-specific values for the rest of the parameters in group [50 Fieldbus adapter \(FBA\)](#), starting from [50.04](#). Examples of appropriate values are shown in the tables below.
  6. Set the fieldbus adapter module configuration parameters in group [51 FBA A settings](#). At the minimum, set the required node address and the communication profile.
  7. Define the process data transferred to and from the drive in parameter groups [52 FBA A data in](#) and [53 FBA A data out](#).  
**Note:** The adapter module sets the Status word and Control word automatically into parameters [52.01](#) and [53.01](#) respectively.
  8. Save the valid parameter values to permanent memory by setting parameter [96.07 Parameter save](#) to *Save*.
  9. Validate the settings made in parameter groups 51, 52 and 53 by setting parameter [51.27 FBA par refresh](#) to *Configure*.
  10. Set the relevant drive control parameters to control the drive according to the application. Examples of appropriate values are shown in the tables below.
-

## ■ Parameter setting example: FPBA (PROFIBUS DP)

This example shows how to configure a basic speed control application that uses the PROFIdrive communication profile with PPO Type 2. The start/stop commands and reference are according to the PROFIdrive profile, speed control mode.

The reference value  $\pm 16384$  (4000h) corresponds to parameter [46.01 Speed scaling](#) in the forward and reverse directions.

Direction	PZD1	PZD2	PZD3	PZD4	PZD5	PZD6
Out	Control word	Speed reference	Acc time 1		Dec time 1	
In	Status word	Speed actual value	Motor current		DC voltage	

The table below gives the recommended drive parameter settings.

Drive parameter	Setting for ACS880 drives	Description
<a href="#">50.01 FBA A enable</a>	<b>1</b> = <i>Enable</i>	Enables communication between the drive and the fieldbus adapter module.
<a href="#">50.04 FBA A ref1 type</a>	<b>4</b> = <i>Speed</i>	Selects the fieldbus A reference 1 type and scaling.
<a href="#">50.07 FBA A actual 1 type</a>	<b>0</b> = <i>Auto</i>	Selects the actual value type and scaling according to the currently active Ref1 mode defined in parameter <a href="#">50.04</a> .
<a href="#">51.01 FBA type</a>	<b>1</b> = FPBA <sup>1)</sup>	Displays the type of the fieldbus adapter module.
51.02 Node address	3 <sup>2)</sup>	Defines the PROFIBUS node address of the fieldbus adapter module.
51.03 Baud rate	12000 <sup>1)</sup>	Displays the current baud rate on the PROFIBUS network in kbit/s.
51.04 MSG type	<b>1</b> = PPO <sup>1)</sup>	Displays the telegram type selected by the PLC configuration tool.
51.05 Profile	<b>0</b> = PROFIdrive	Selects the Control word according to the PROFIdrive profile (speed control mode).
51.07 RPBA mode	<b>0</b> = Disabled	Disables the RPBA emulation mode.
52.01 FBA data in1	<b>4</b> = SW 16bit <sup>1)</sup>	Status word
52.02 FBA data in2	<b>5</b> = Act1 16bit	Actual value 1
52.03 FBA data in3	01.07 <sup>2)</sup>	Motor current
52.05 FBA data in5	01.11 <sup>2)</sup>	DC voltage
53.01 FBA data out1	<b>1</b> = CW 16bit <sup>1)</sup>	Control word
53.02 FBA data out2	<b>2</b> = Ref1 16bit	Reference 1 (speed)
53.03 FBA data out3	23.12 <sup>2)</sup>	Acceleration time 1
53.05 FBA data out5	23.13 <sup>2)</sup>	Deceleration time 1

Drive parameter	Setting for ACS880 drives	Description
<i>51.27 FBA par refresh</i>	<b>1</b> = <i>Configure</i>	Validates the configuration parameter settings.
<i>19.12 Ext1 control mode 1</i>	<b>2</b> = <i>Speed</i>	Selects speed control as the control mode 1 for external control location EXT1.
<i>20.01 Ext1 commands</i>	<b>12</b> = <i>Fieldbus A</i>	Selects fieldbus adapter A as the source of the start and stop commands for external control location EXT1.
<i>20.02 Ext1 start trigger</i>	<b>1</b> = <i>Level</i>	Selects a level-triggered start signal for external control location EXT1.
<i>22.11 Speed ref1 selection</i>	<b>4</b> = <i>FB A ref1</i>	Selects fieldbus A reference 1 as the source for speed reference 1.

1) Read-only or automatically detected/set

2) Example

The start sequence for the parameter example above is given below.

Control word:

- 47Eh (1150 decimal) → READY TO SWITCH ON
- 47Fh (1151 decimal) → OPERATING (Speed mode)





# Drive-to-drive link

---

This feature is not supported by the current firmware version.





# Control chain diagrams

---

## What this chapter contains

The chapter presents the reference chains of the drive. For a general diagram, see section [Operating modes of the drive](#) (page 20).

# Speed reference source selection I

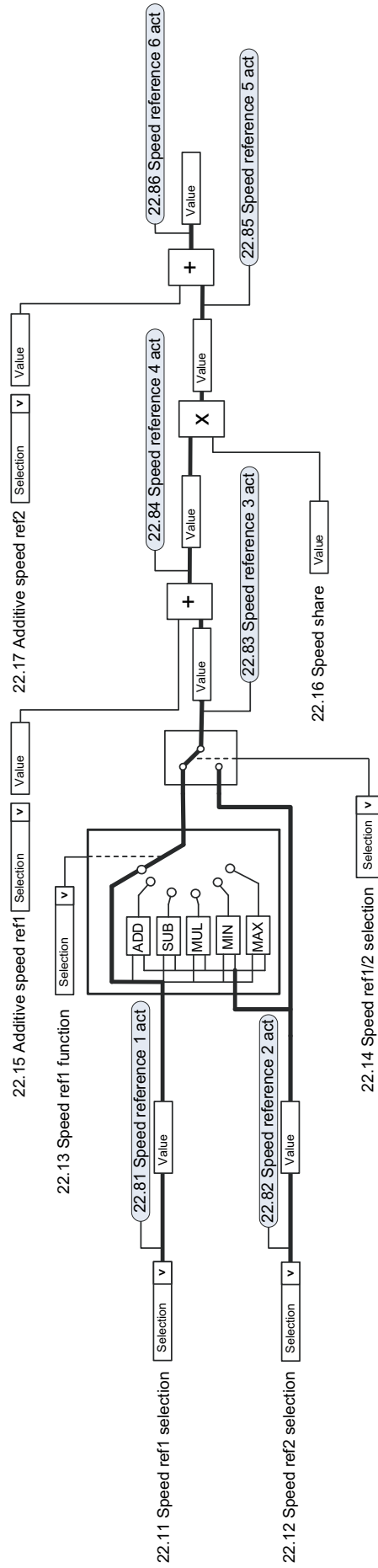

# Speed reference source selection II

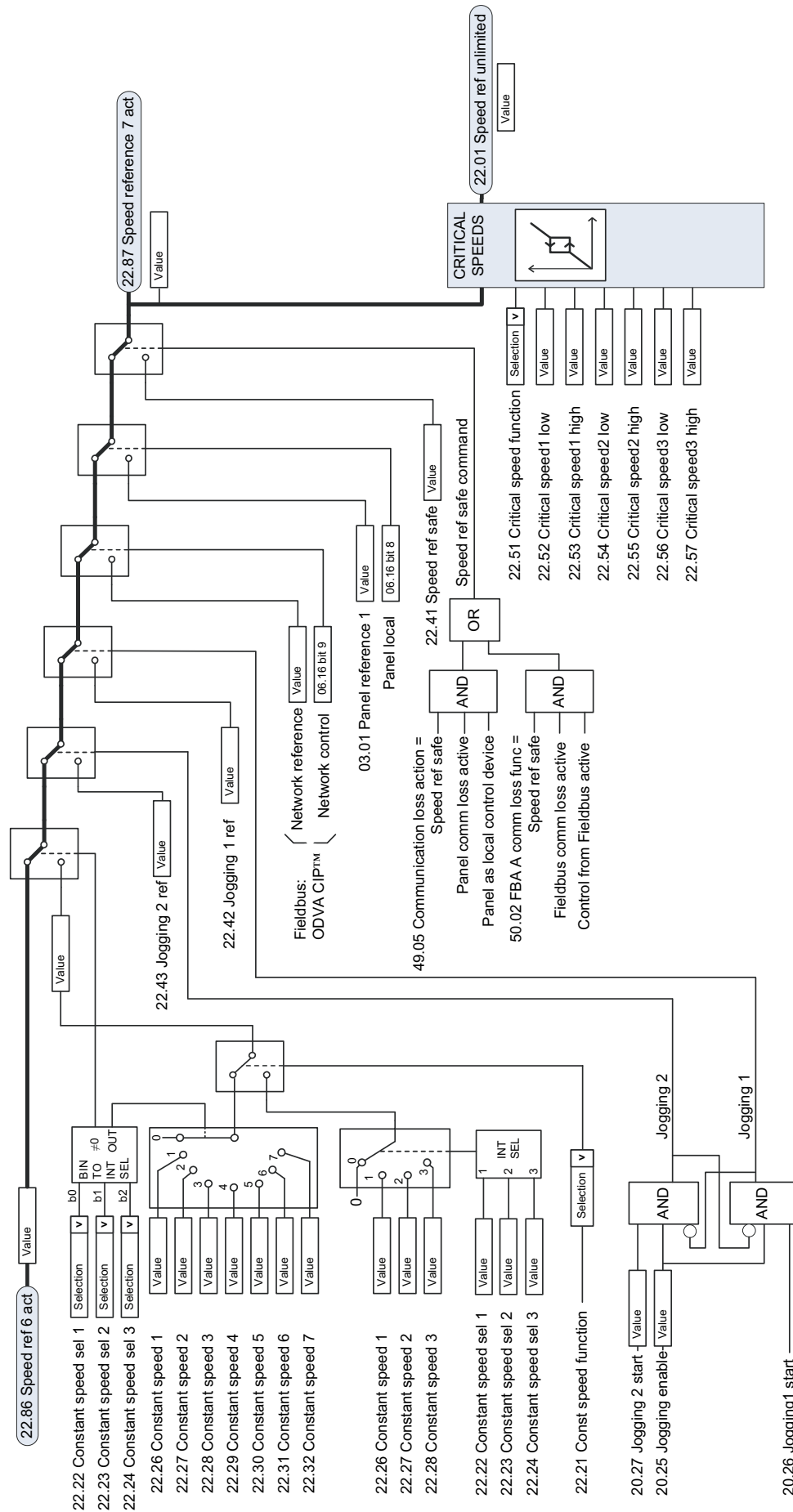

# Speed reference ramping and shaping

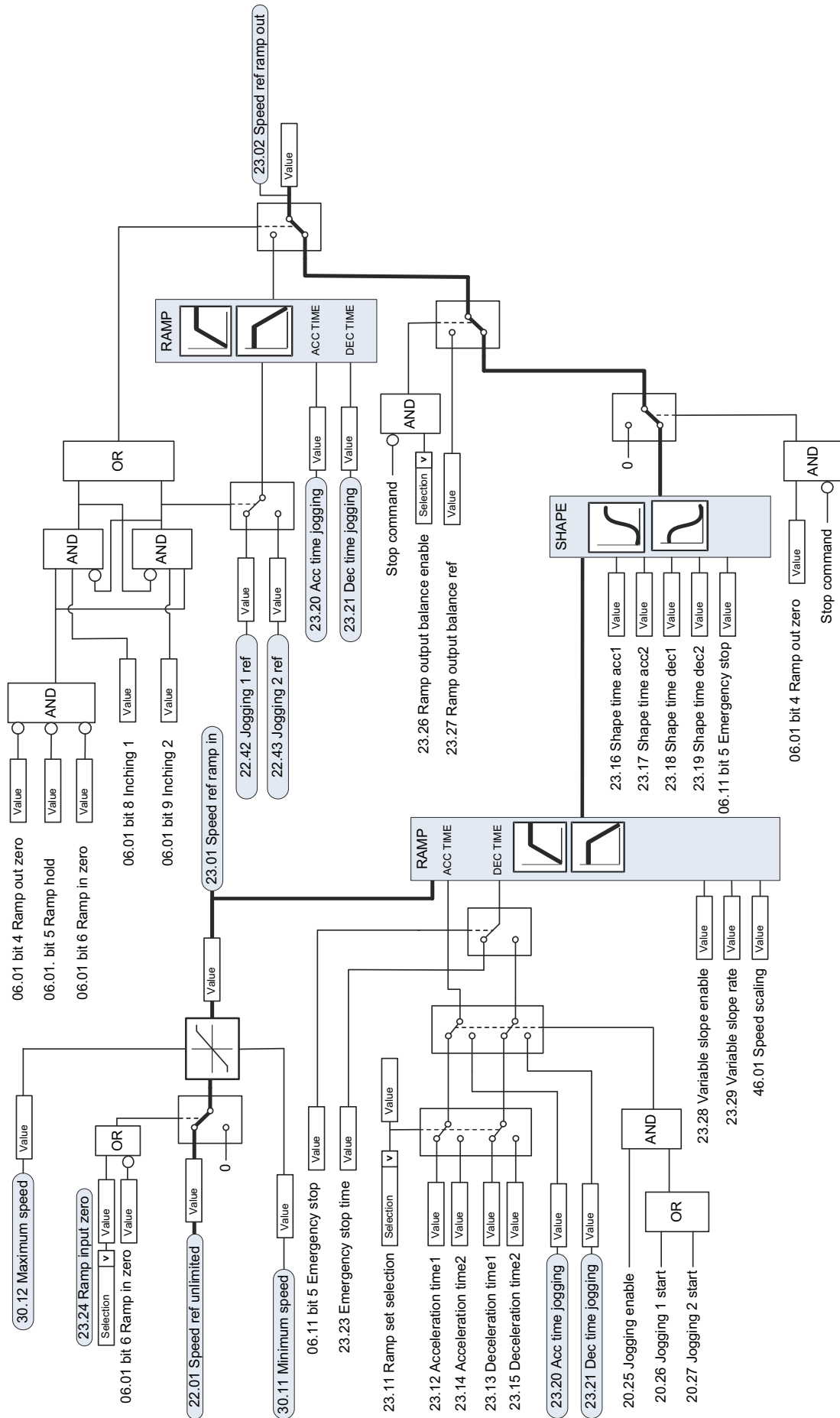

# Motor feedback configuration

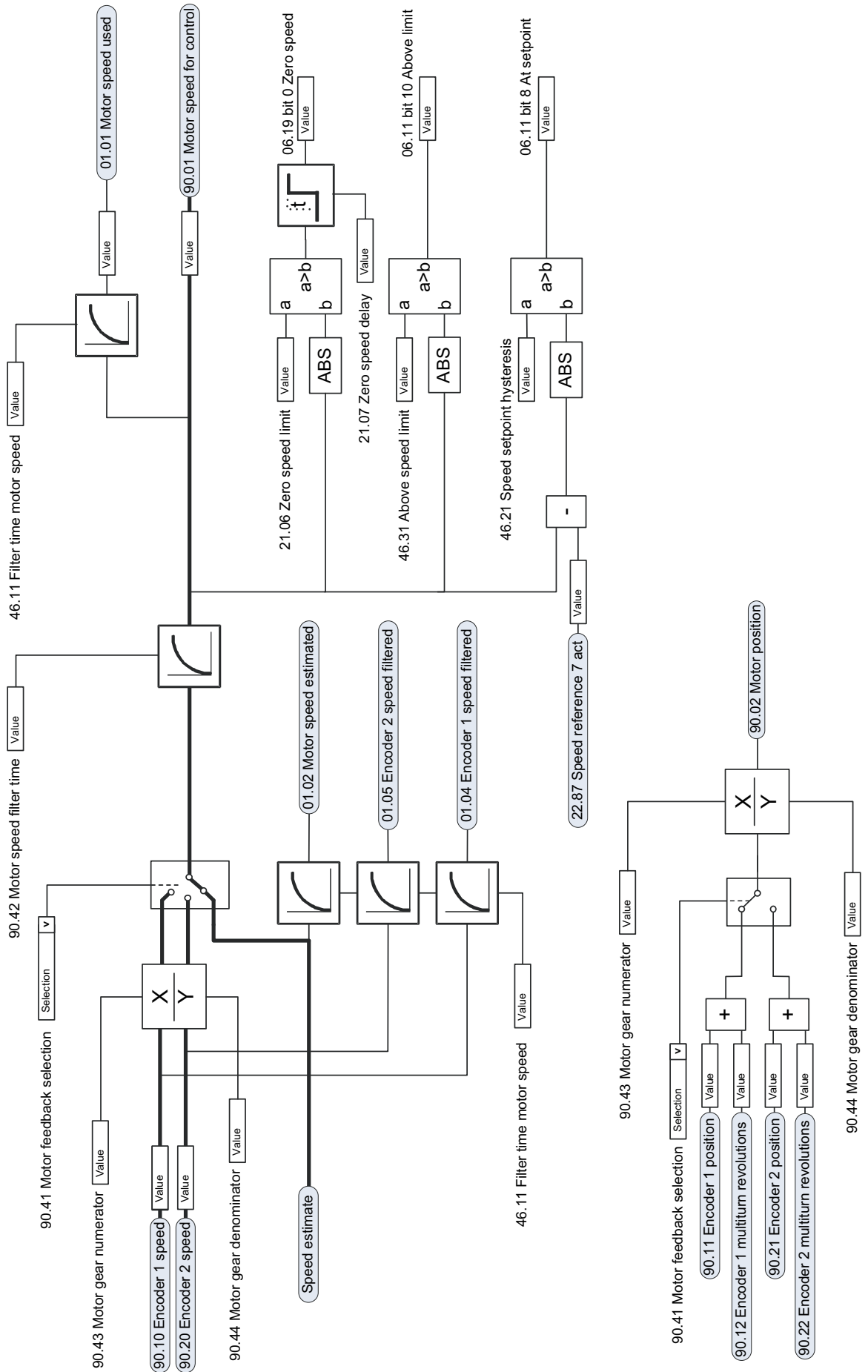

# Speed error calculation

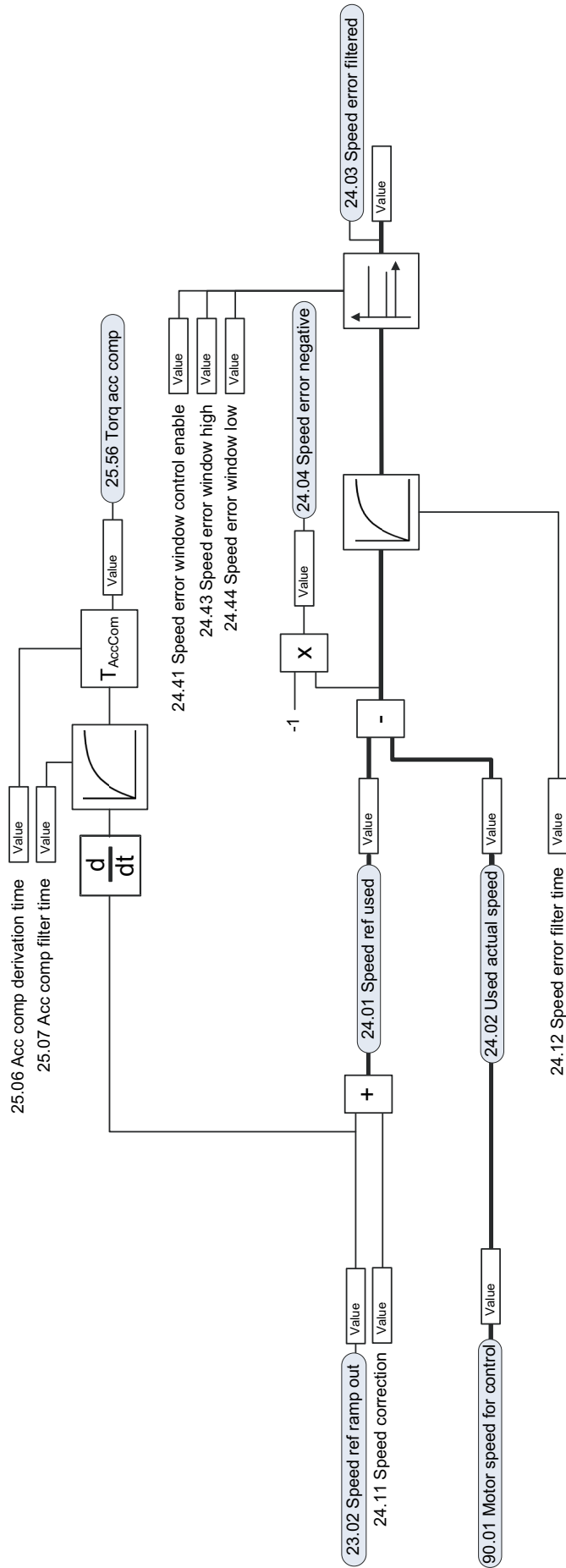



# Speed controller

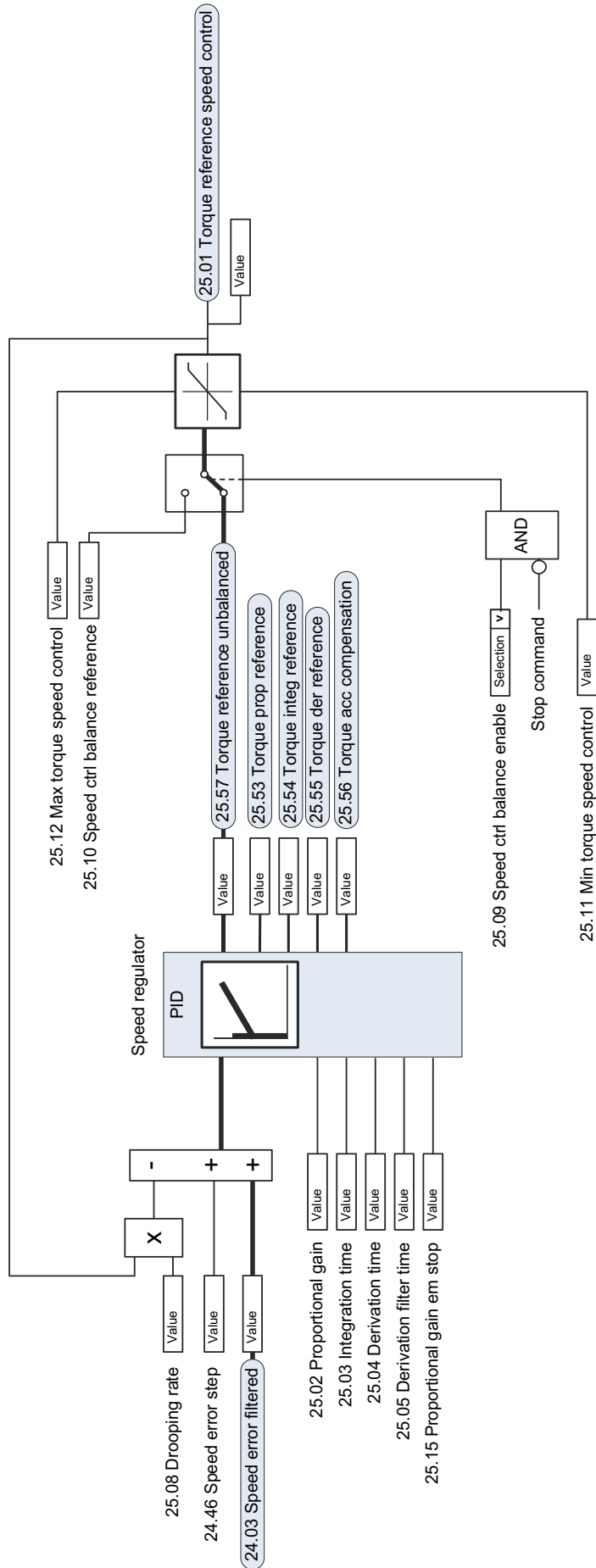

# Torque reference source selection and modification

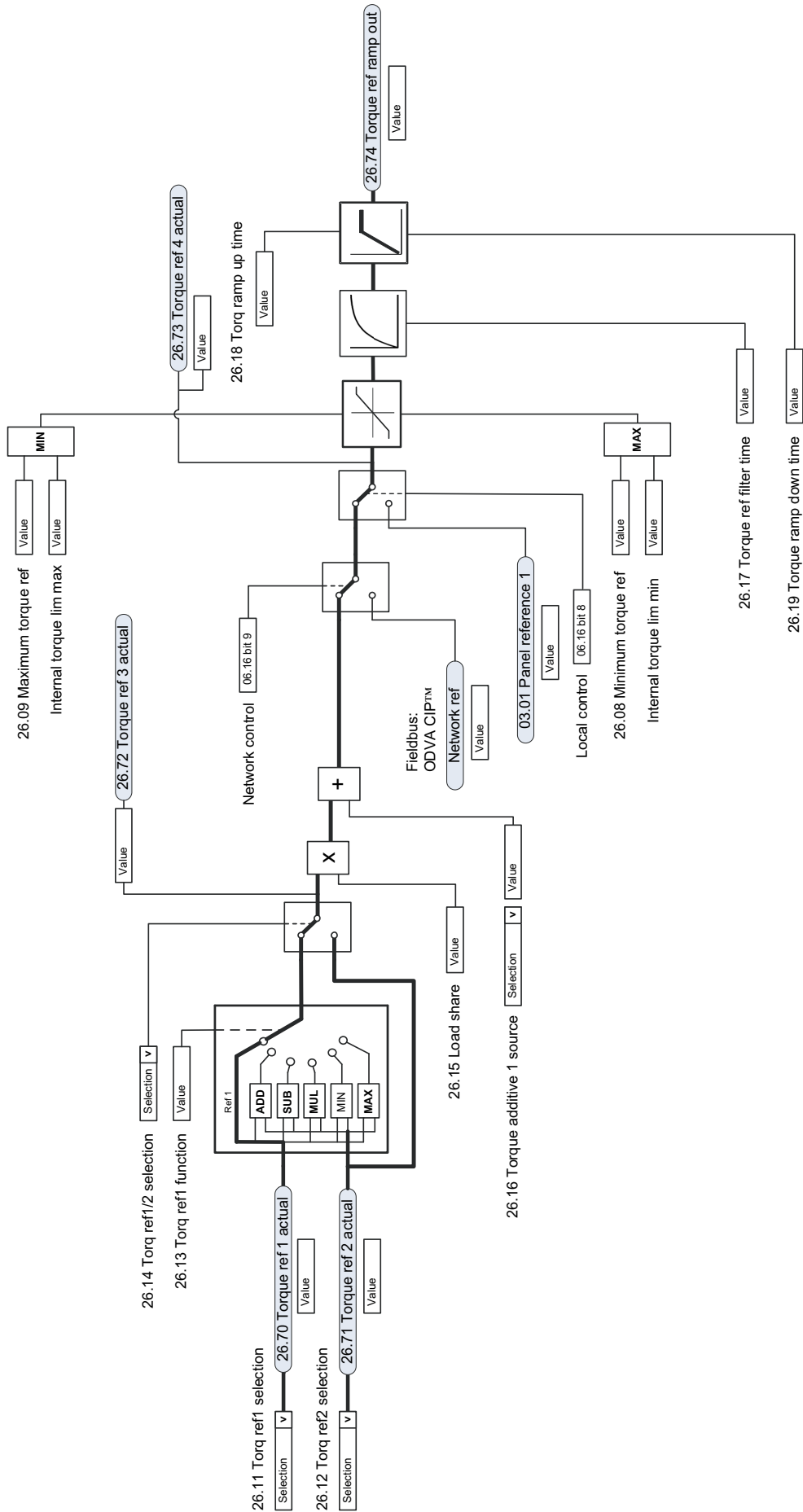

# Reference selection for torque controller I

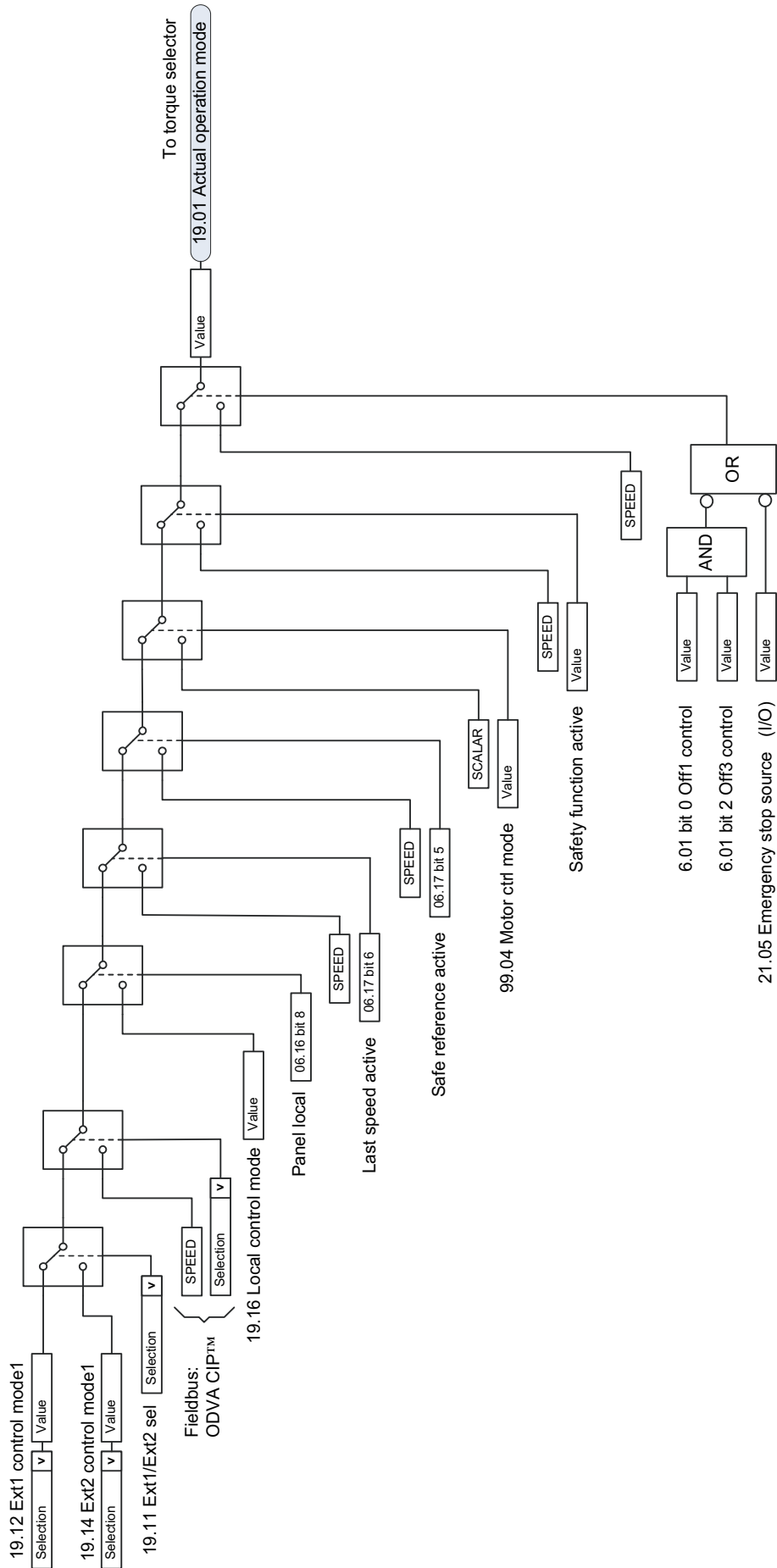

## Reference selection for torque controller II

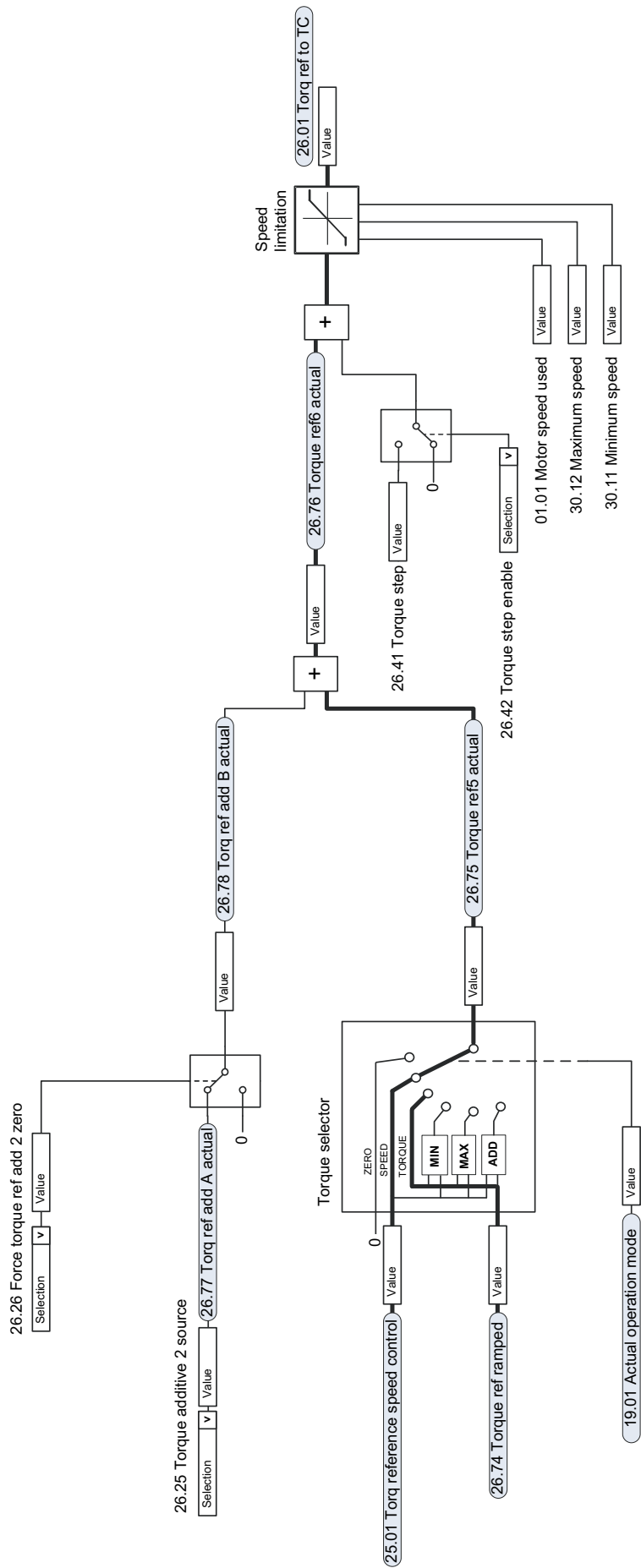

# Torque limitation

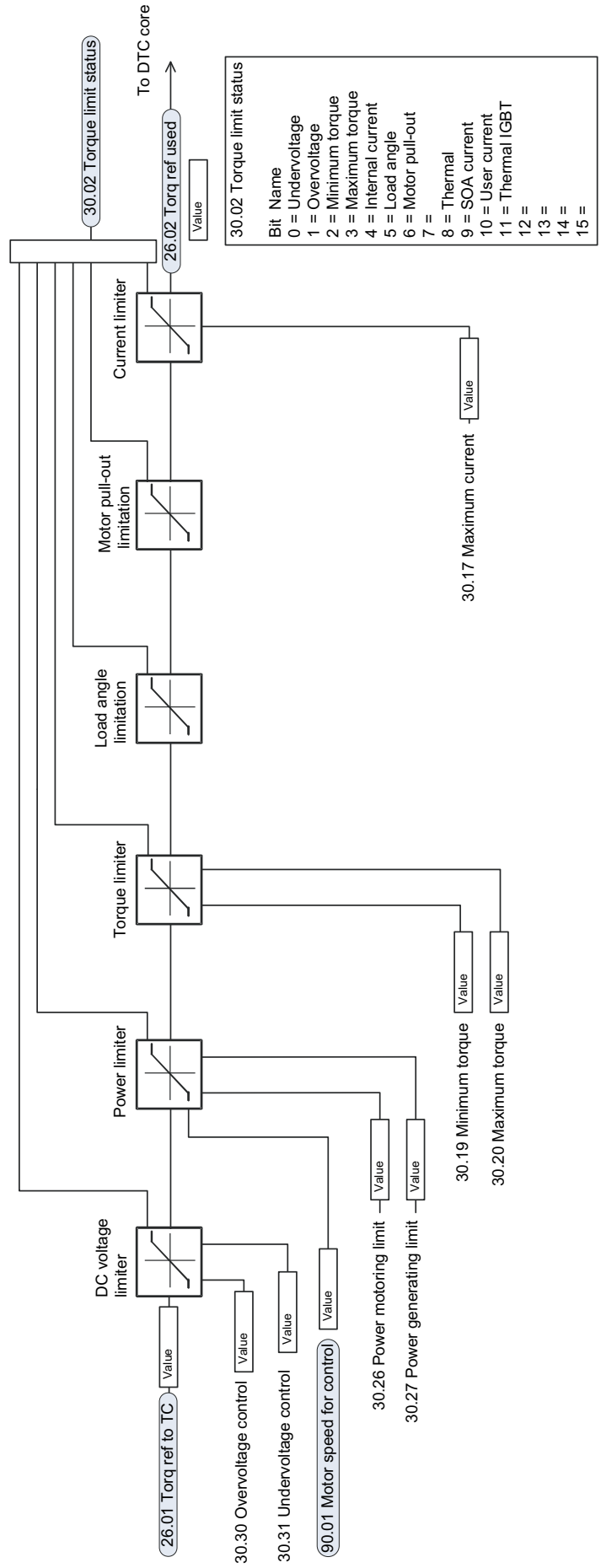

# Frequency reference selection

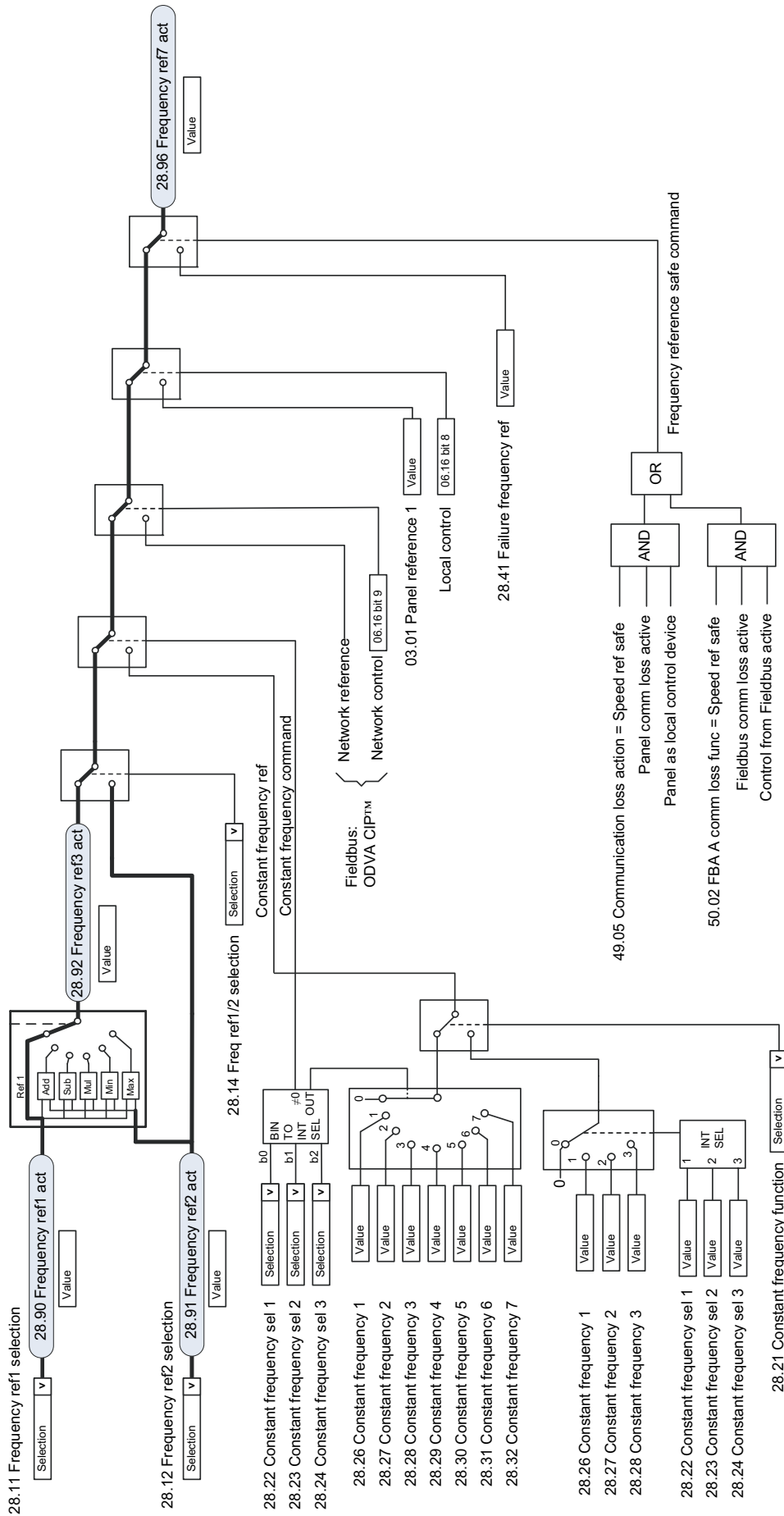

# Frequency reference modification

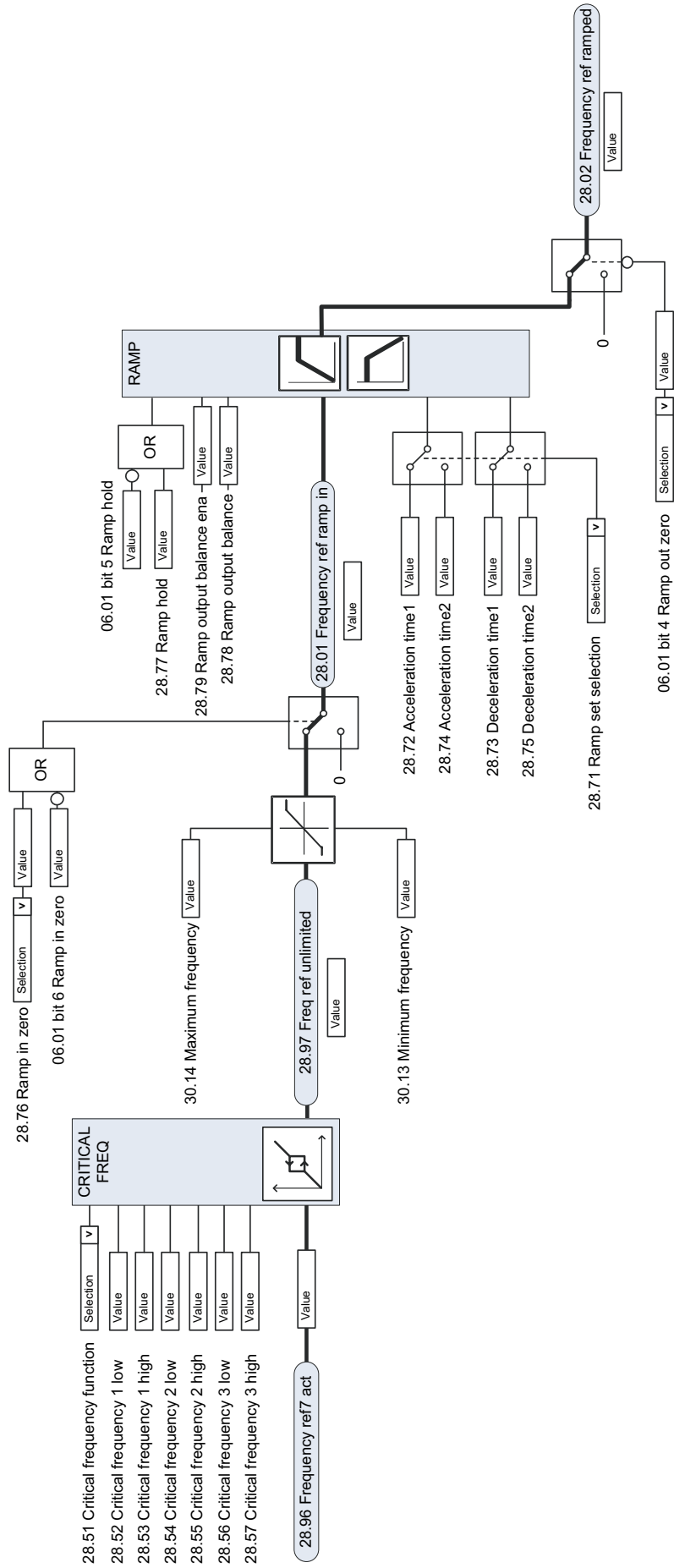

# Process PID setpoint and feedback source selection

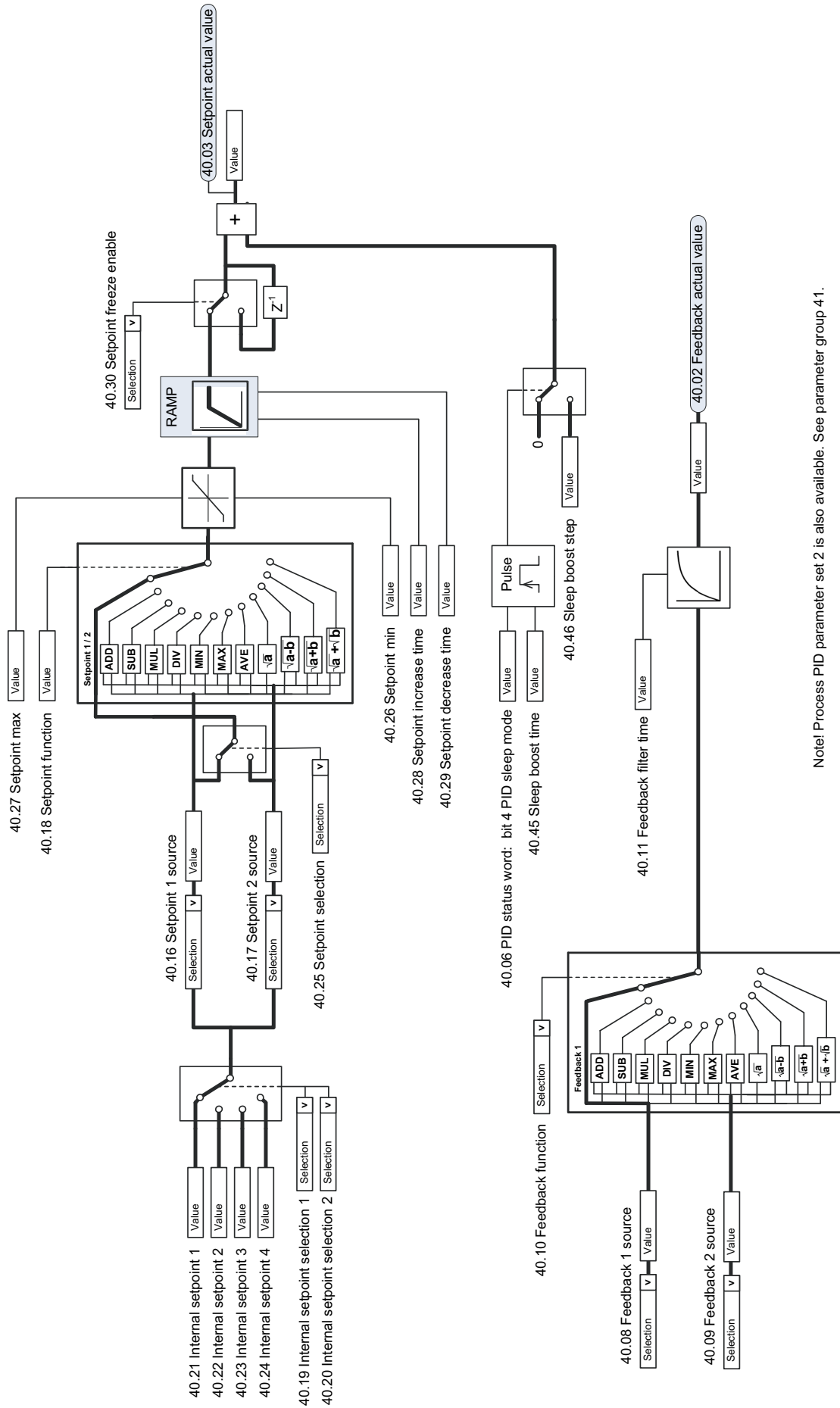

Note! Process PID parameter set.2 is also available. See parameter group 41.



# Process PID controller

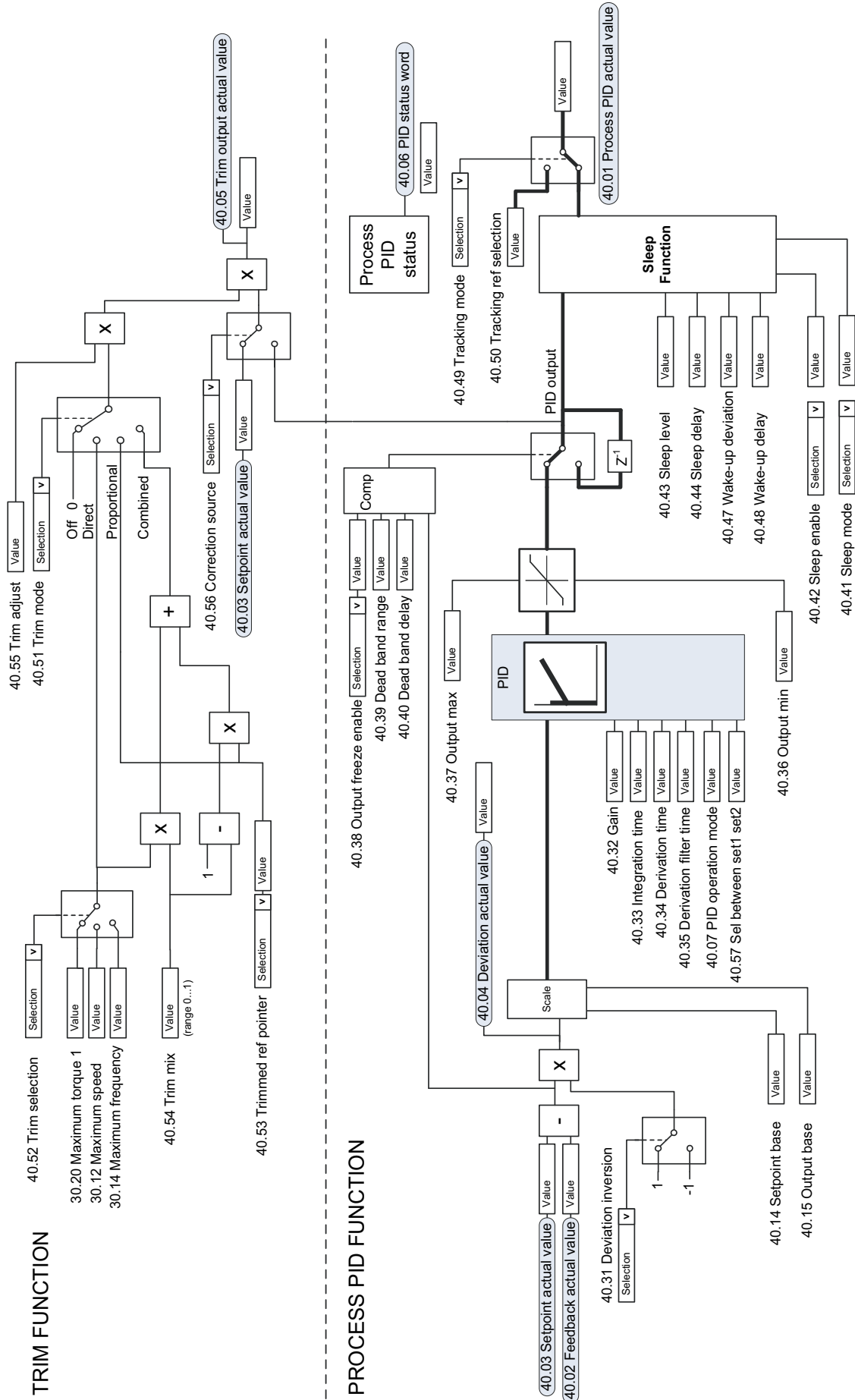

Note! Process PID parameter set 2 is also available. See parameter group 41.

# Master/Follower communication I (Master)

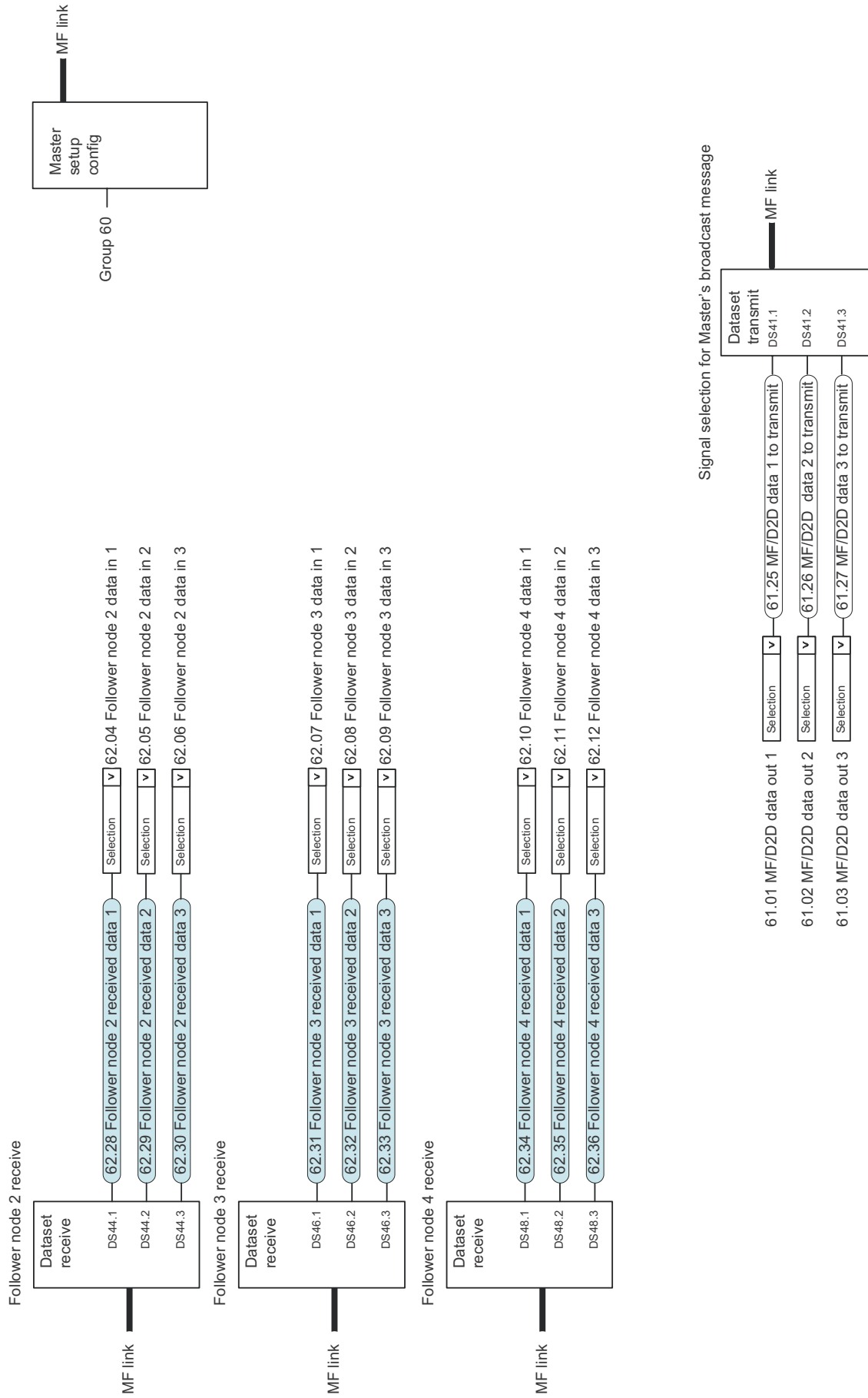

# Master/Follower communication II (Follower)

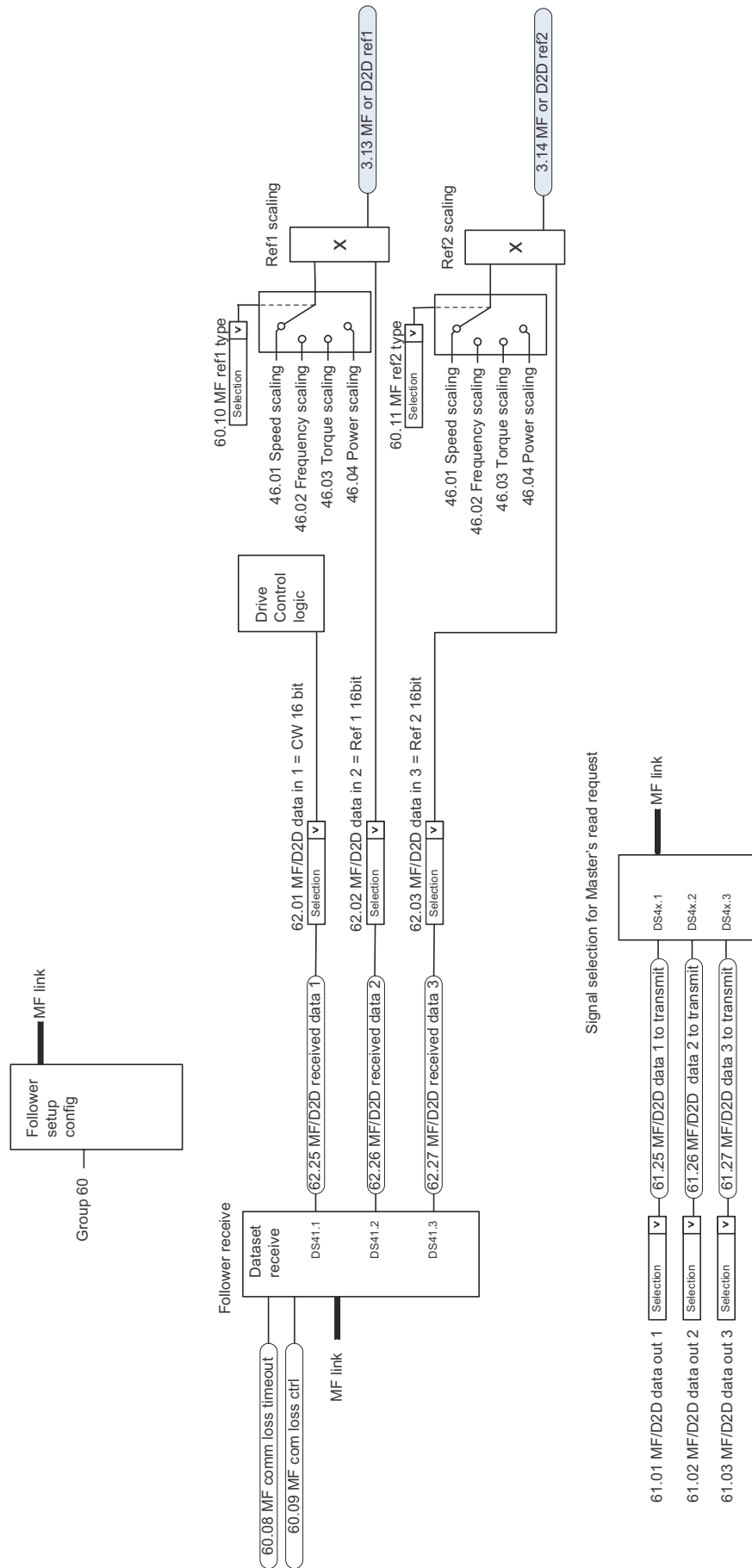



## Further information

### Product and service inquiries

Address any inquiries about the product to your local ABB representative, quoting the type designation and serial number of the unit in question. A listing of ABB sales, support and service contacts can be found by navigating to [www.abb.com/drives](http://www.abb.com/drives) and selecting *Sales, Support and Service network*.

### Product training

For information on ABB product training, navigate to [www.abb.com/drives](http://www.abb.com/drives) and select *Training courses*.

### Providing feedback on ABB Drives manuals

Your comments on our manuals are welcome. Go to [www.abb.com/drives](http://www.abb.com/drives) and select *Document Library – Manuals feedback form (LV AC drives)*.

### Document library on the Internet

You can find manuals and other product documents in PDF format on the Internet. Go to [www.abb.com/drives](http://www.abb.com/drives) and select *Document Library*. You can browse the library or enter selection criteria, for example a document code, in the search field.

# Contact us

[www.abb.com/drives](http://www.abb.com/drives)

[www.abb.com/drivespartners](http://www.abb.com/drivespartners)

3AJUA0000085967 Rev D (EN) EFFECTIVE: 2012-07-16

Power and productivity  
for a better world™

